

Design, Development and Commissioning Results for Suppressing Rogue Microwaves Impacting the APS Storage Ring Vertical BPM Readings

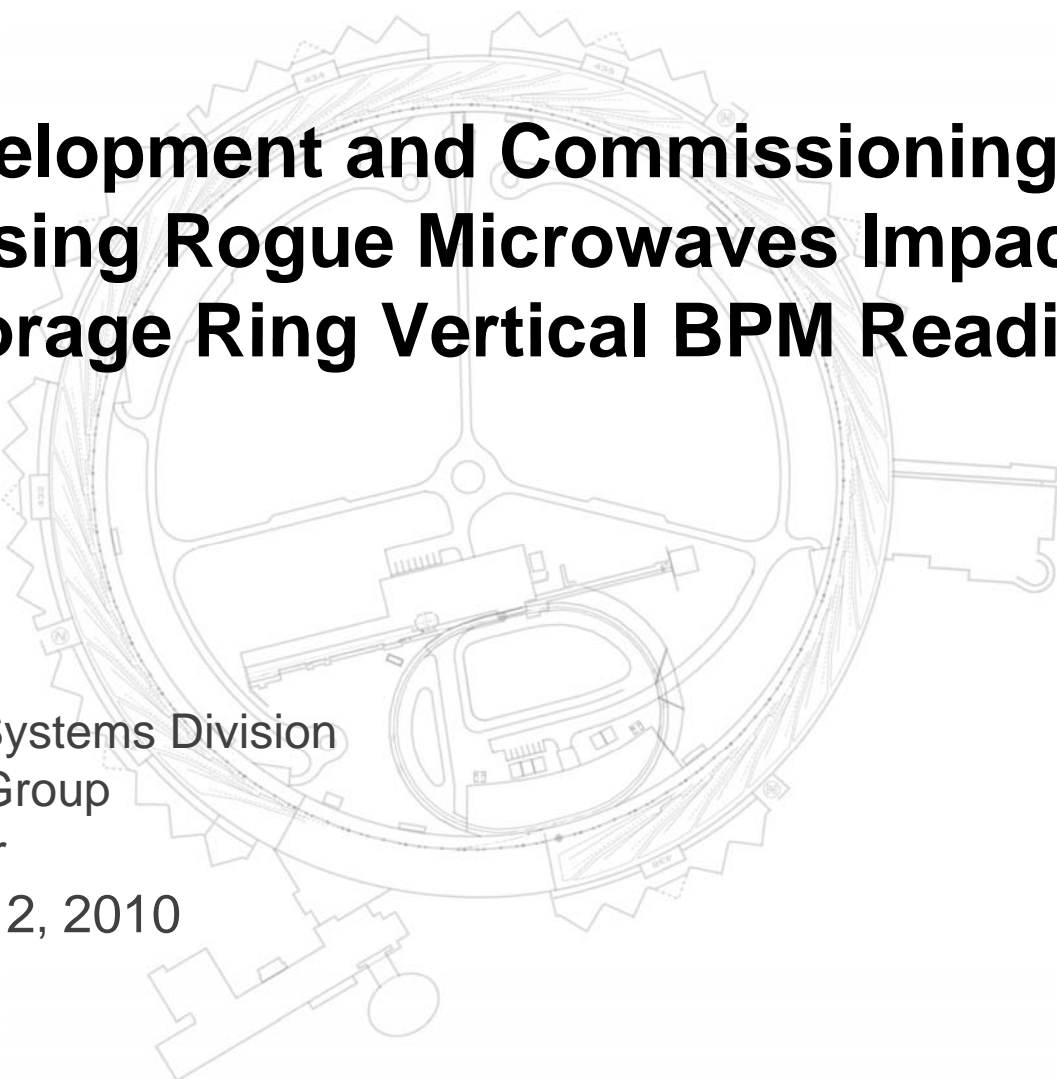

Bob Lill
Accelerator Systems Division
Diagnostics Group
ASD Seminar
November 12, 2010

Step Changes in Vertical BPM Measurements???

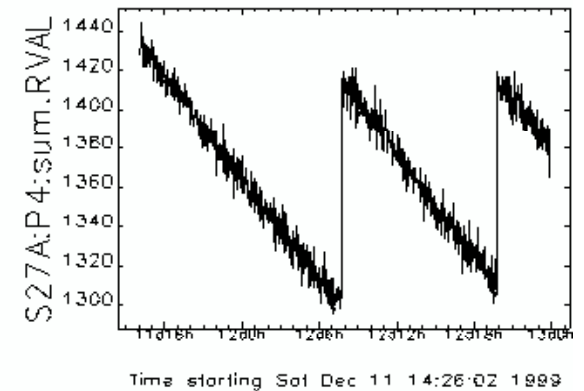
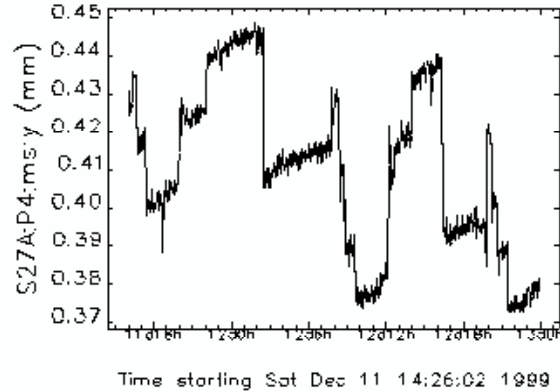
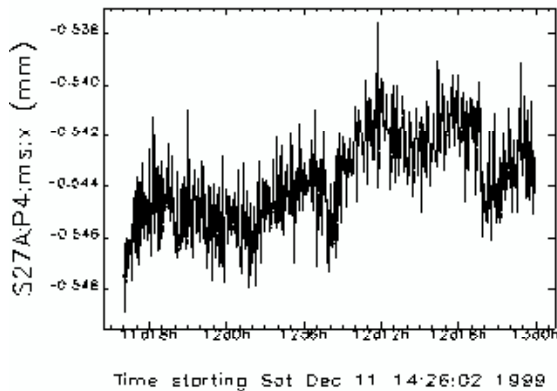
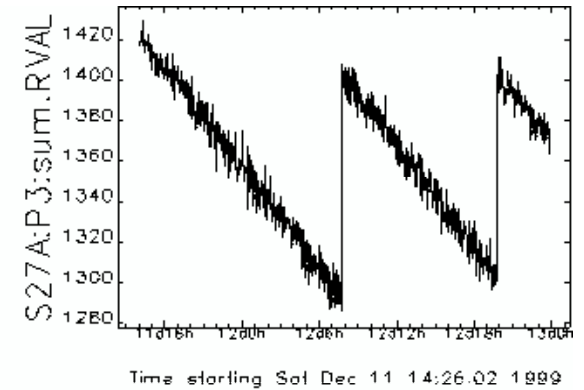
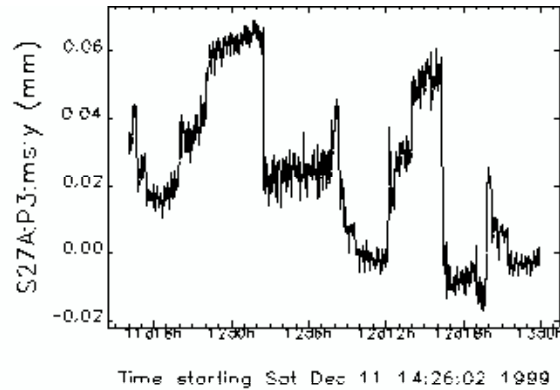
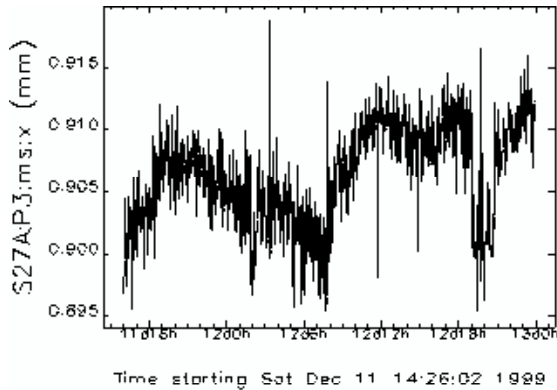

Erroneous step changes in beam position measurements and systematic intensity dependence in the vertical plane have been traced to trapped modes in the vacuum chamber, placing a fundamental limitation on vertical beam position stabilization



History

- Discovered TE modes exist corrupting BPM vertical signals 1998
- Coaxial damper and lossy ceramic installed sector 29 and 27, 5/2000 and 9/2000 work request # 17 and 34
- PAC paper 1999
- Other labs using similar vacuum chamber found same problems
- Mafia simulation 2003
- Simulation and LS-299 note shorting plate in antechamber
- Conclusion shorting plate in antechamber cannot separate the frequency of every mode
- 2009 re-measure chamber and started R&D effort



R & D Measurements (fall 2009)

Goal

- Determine if rogue modes could be suppressed by periodically shorting high field regions of the anti-chamber
- ✓ Set-up curved chamber at building 382 and measured resonances in a curved chamber
- ✓ Launched vertically polarized signals in the BPM buttons using 180 degree hybrids confirming original experiments
- ✓ Verified transmission through the vacuum chamber with a cut-off frequency near 330 MHz
- ✓ Use RF probe to determine high field areas utilizing access from antechamber pumping ports
- ✓ Designed and built “E” and “H” type probes to simulate TE mode into chamber



RF measurements of a storage ring vacuum chamber

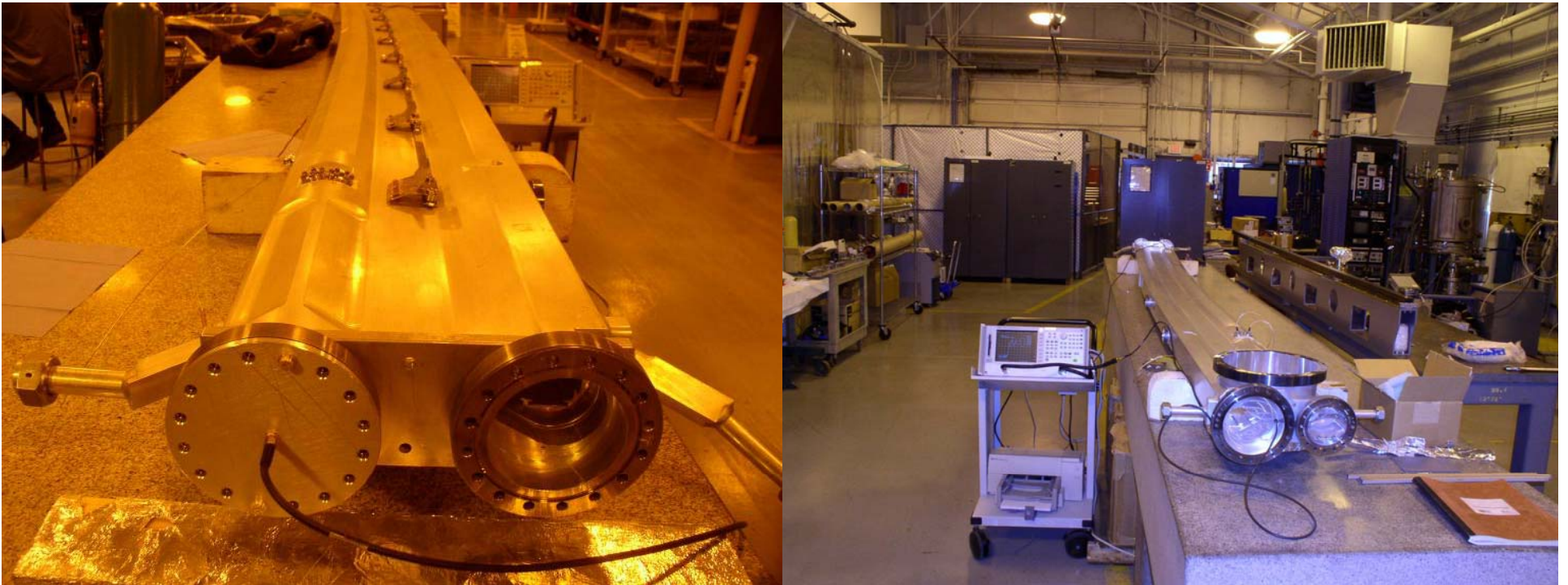

An electric field probe launched a vertically polarized signal from one end of the chamber to a down stream BPM button used to receive the signal.

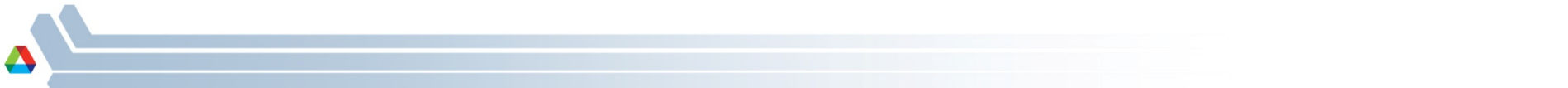

Curved Chamber "AS BUILT"

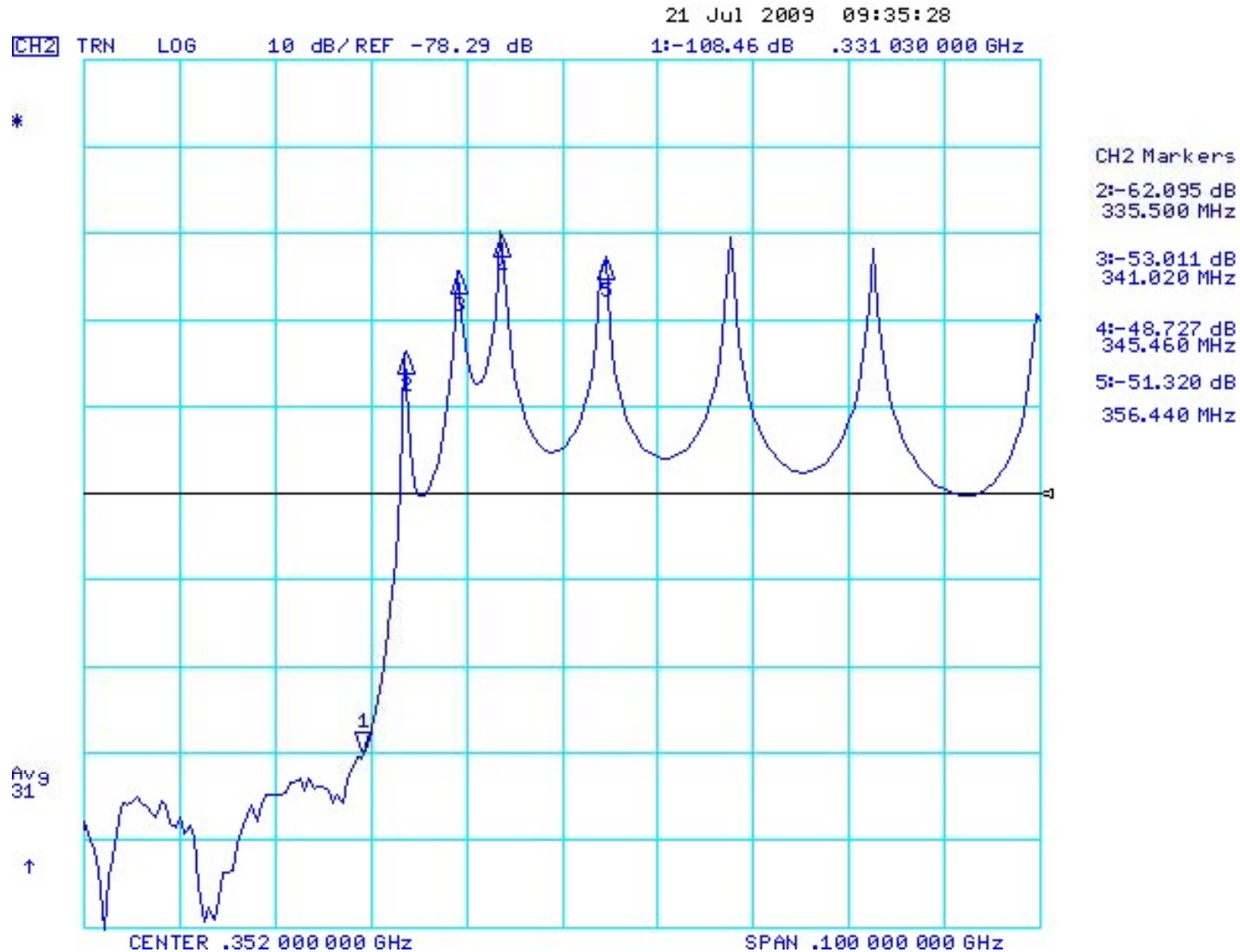

This plot shows the cut-off frequency measured is about 331 MHz and the first resonance is 335.5 MHz.



Low resistivity probe inserted at vacuum pumping ports to shunt 10 mm gap

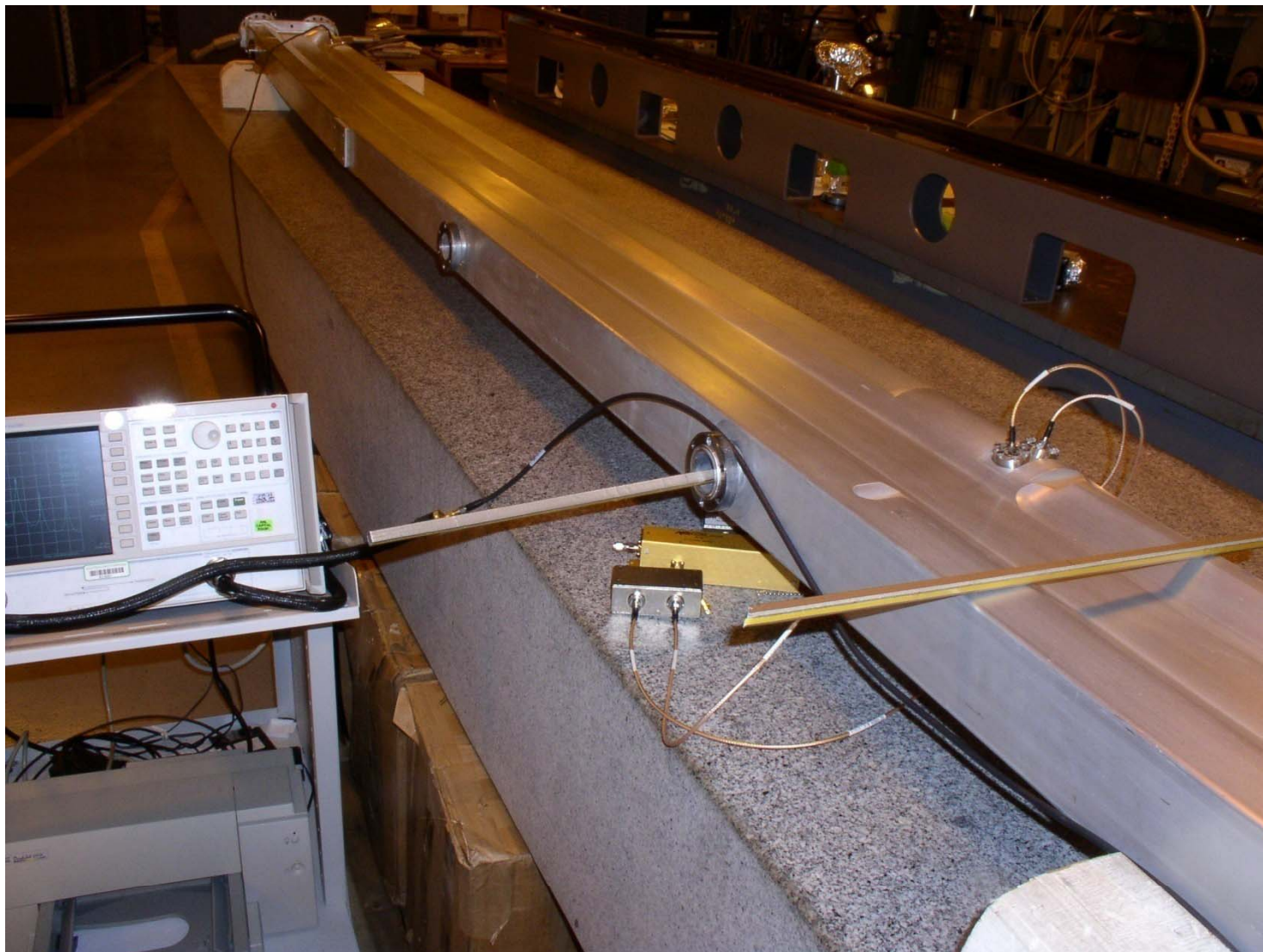

Added 3rd downstream shunt 50 mm into 10 mm gap

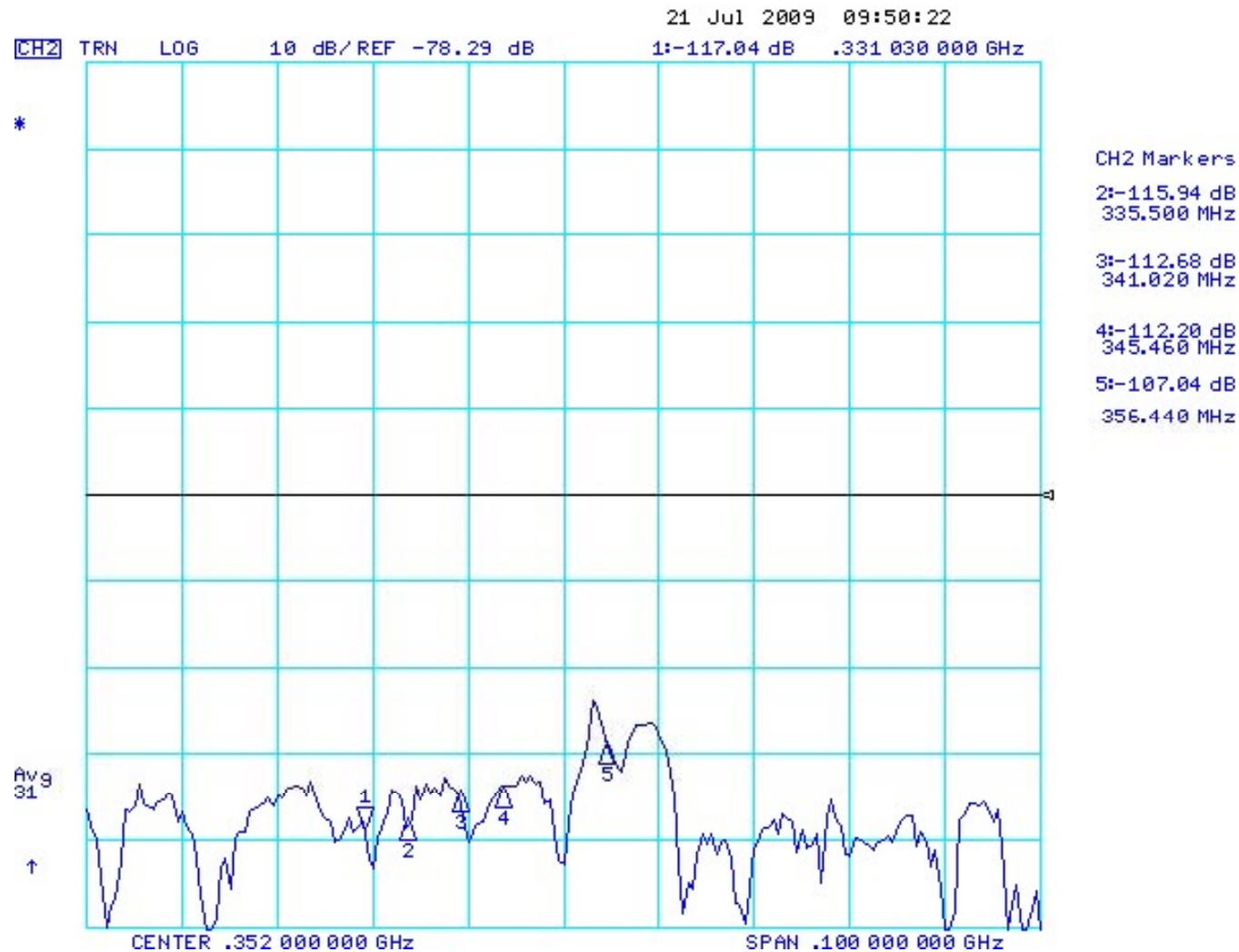

This plot shows the previous measured resonances (marker values) have been suppressed



R&D Measurement Results and Conclusions

- Due to the geometry of the vacuum chamber, cut-off frequency is approximately 330 MHz
- TE modes are excited in large-aperture vacuum chambers and become trapped between the bellow end flanges
- TE modes are vertically oriented and are superimposed on the TEM beam position signals, corrupting the BPM measurements
- These TE modes place a fundamental limitation on vertical beam position stabilization using “as built” RF BPMs
- By shorting/shunting 10 mm gap region, effective cutoff can be shifted higher

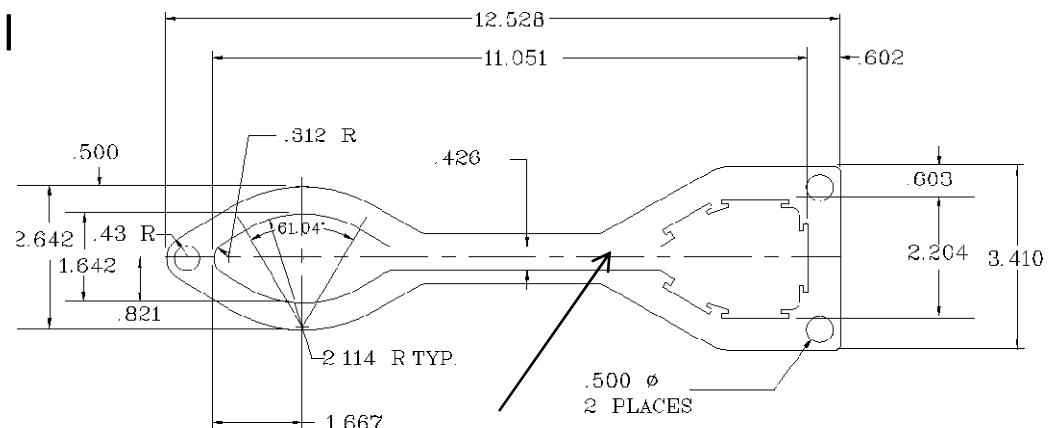

Locate periodic shorts in this area



R&D Phase II Goals

- Shift cut-off frequency by shunting 10 mm gap without intercepting x-rays
- Re-run experiment and verify data
- Simulate shunts in 10 mm gap
- Develop requirements
- Design shunt for real application
- Test, install and refine
- Investigate other chambers

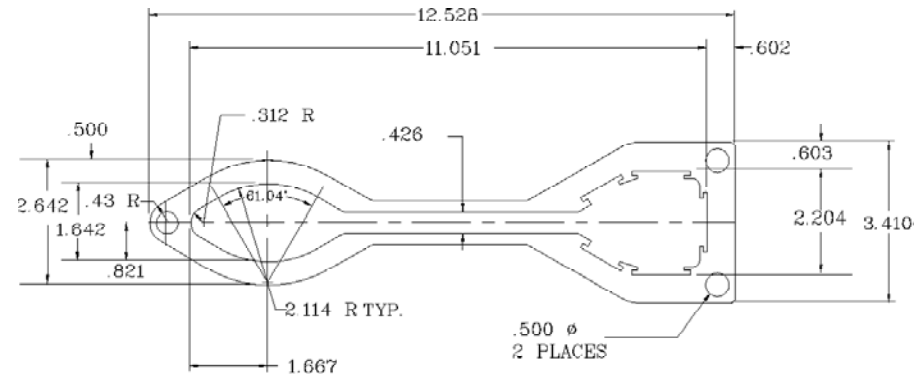

Resonant H₁₀ like modes can be calculated

$$f_{mnp}^H = \frac{c}{2\pi} \sqrt{\left(\frac{2\pi}{\lambda_c}\right)^2 + \left(\frac{p\pi}{L}\right)^2}$$

where c is the velocity of light

λ_c is the cut-off frequency

L is the length



Mafia Simulation S-21 (No Short)

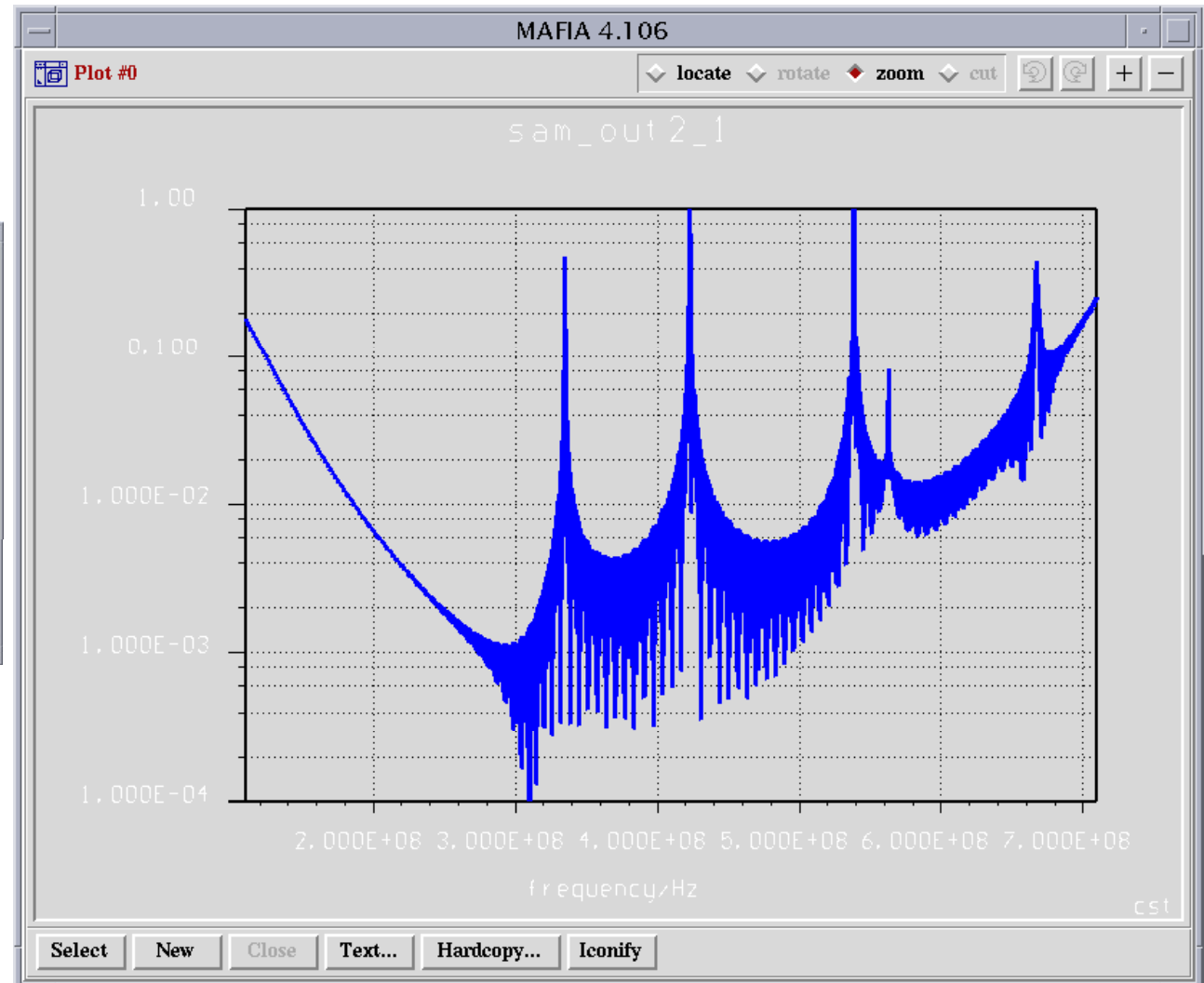
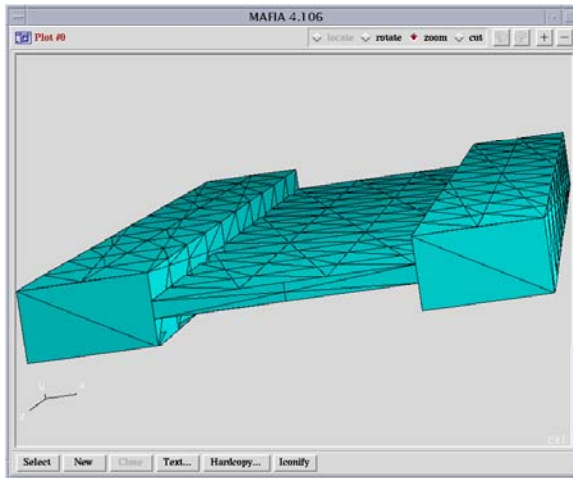

Mafia simulation (Three Shorts)

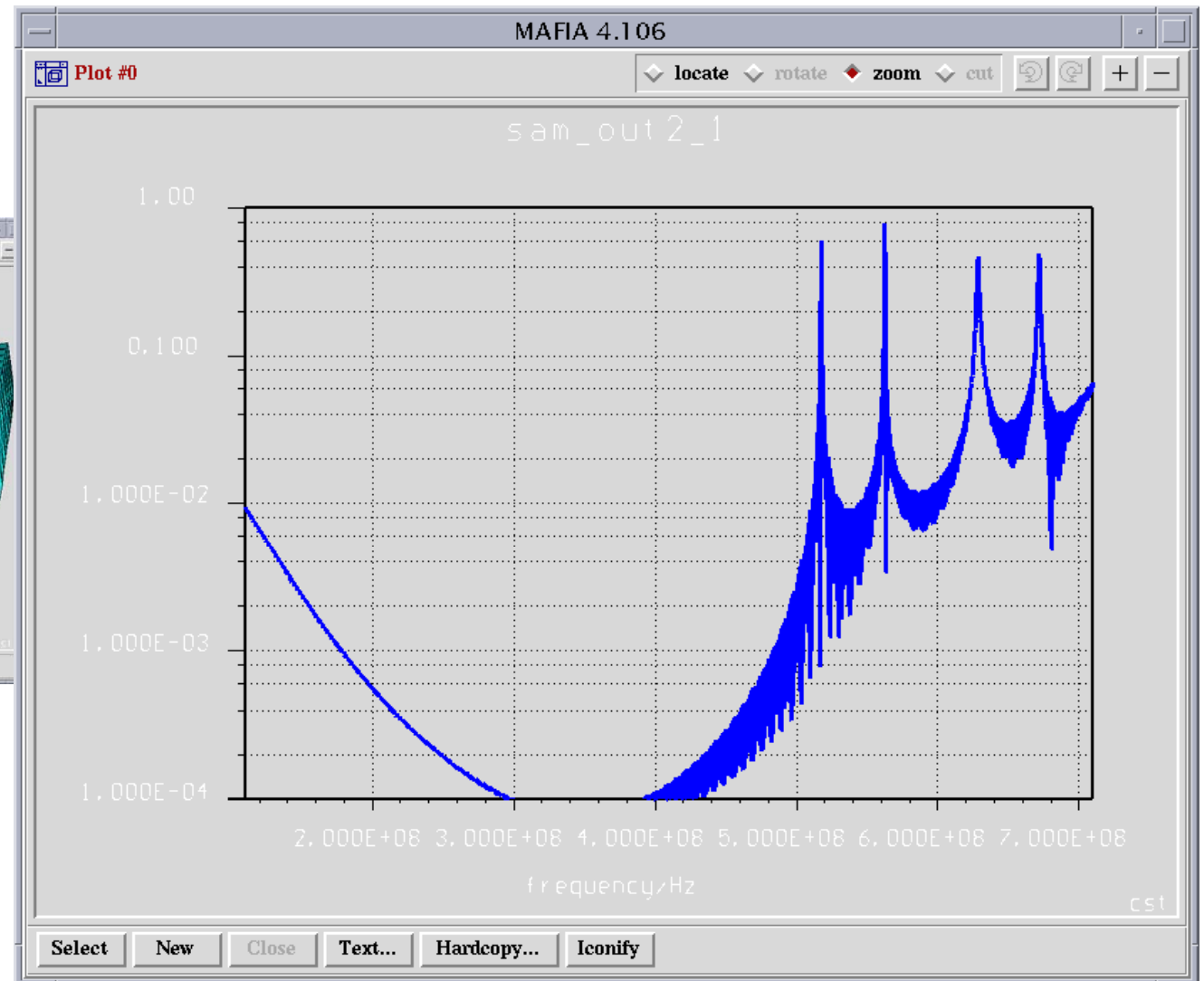
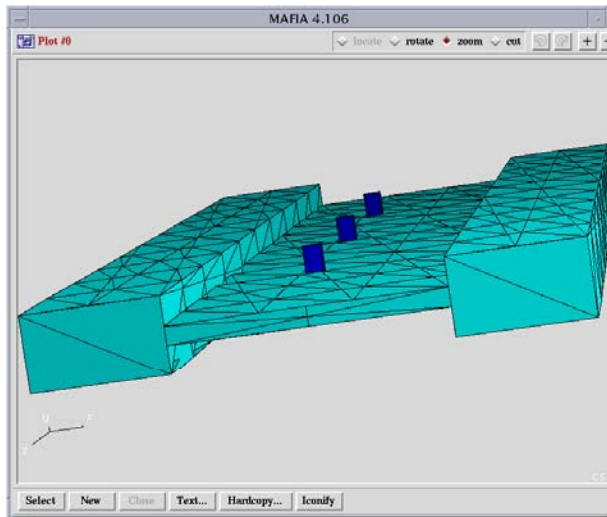

Measured and Calculated Frequencies

Eigen mode Mode number	Measured (MHz)	Calculated (MHz)
1	335.5	330.2
2	341.0	336.5
3	345.5	346.8
4	356.4	360.7
5	369.4	377.8
6	384.6	384.6



Requirements for Suppressing Rogue Modes

- Must have low resistivity at UHF frequencies and short fields in 10 mm gap
- Must not intercept X-rays when installed in chamber
- Must not damage the vacuum chamber when installing
- Reliable
- Must be able to be installed with access only to anti-chamber area
- Using spare getter slot in vacuum chamber, must slide shorting device into position for installation



Additional Mechanical Requirements

- Using a electrician's "fish tape" or equivalent, 9 snubbers linked together must have low resistance to pulling into chamber
- Must be able to install from large flange or small flange openings of vacuum chamber
- Must have safe clearance when installed next to getter strips
- Can be linked together as inserted into the vacuum chamber



Beryllium Copper Longitudinal Grounding Strips

- Use off-the-shelf EMI shielding
- Provides reliable grounding of high field areas
- Will not scratch or damage chamber
- Can be installed similarly to getter strips

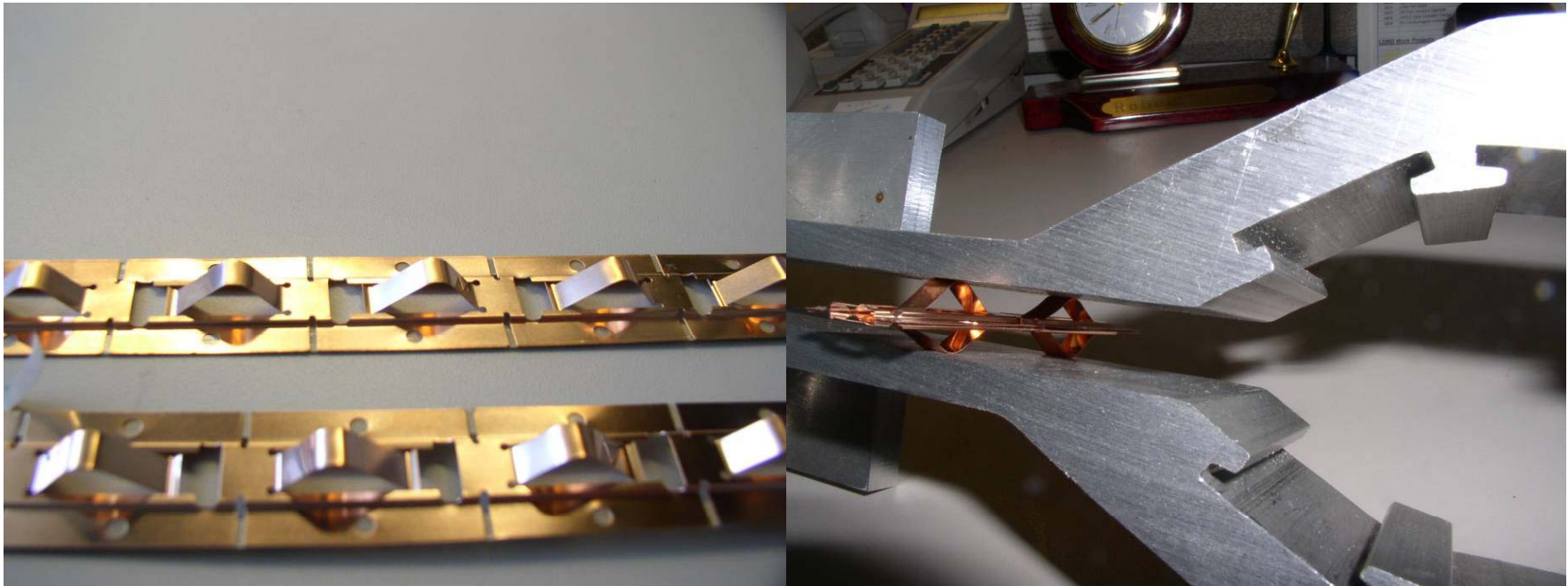

Mode Suppression Design Concepts (Snubber)

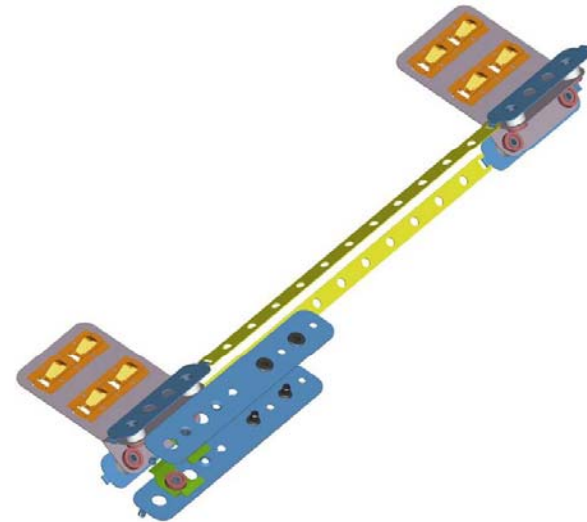
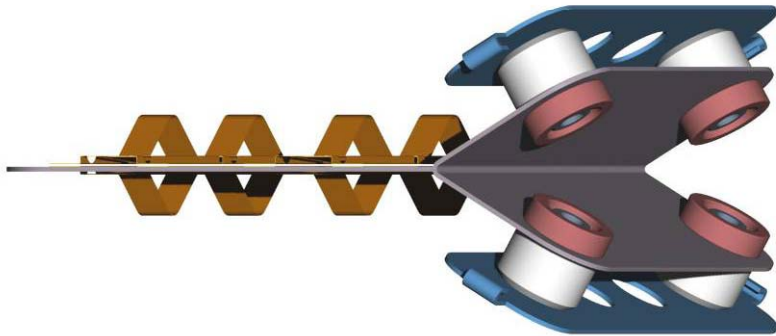
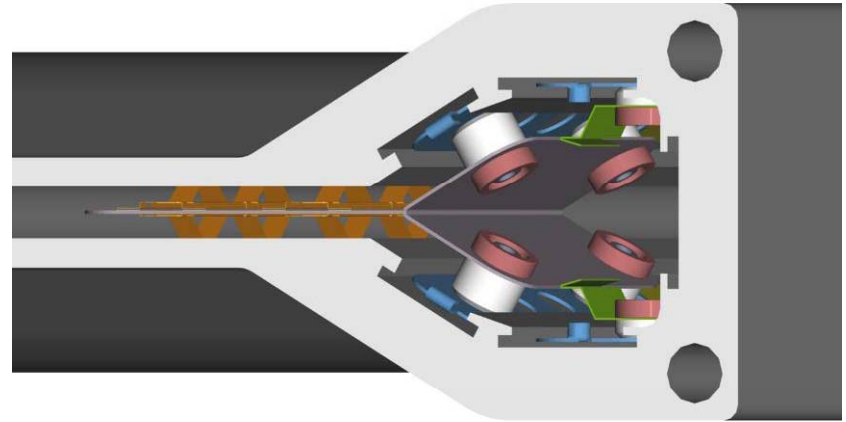
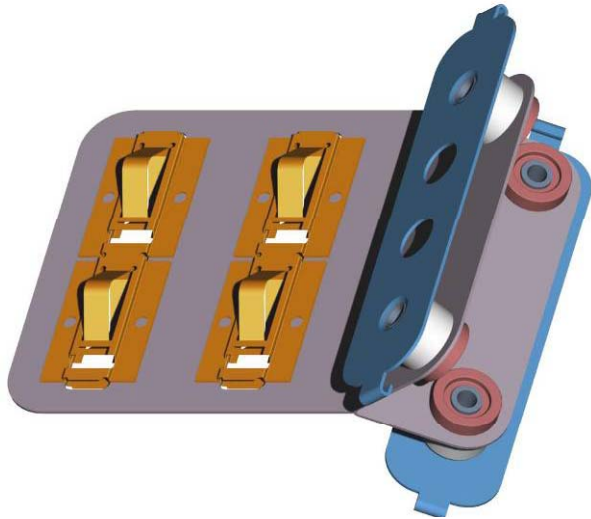

A snubber or snubber circuit is often a simple electrical circuit used to suppress (“snub”) electrical transients

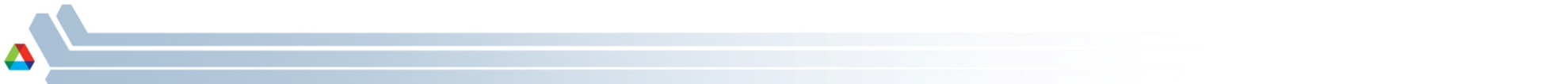

Snubber Design

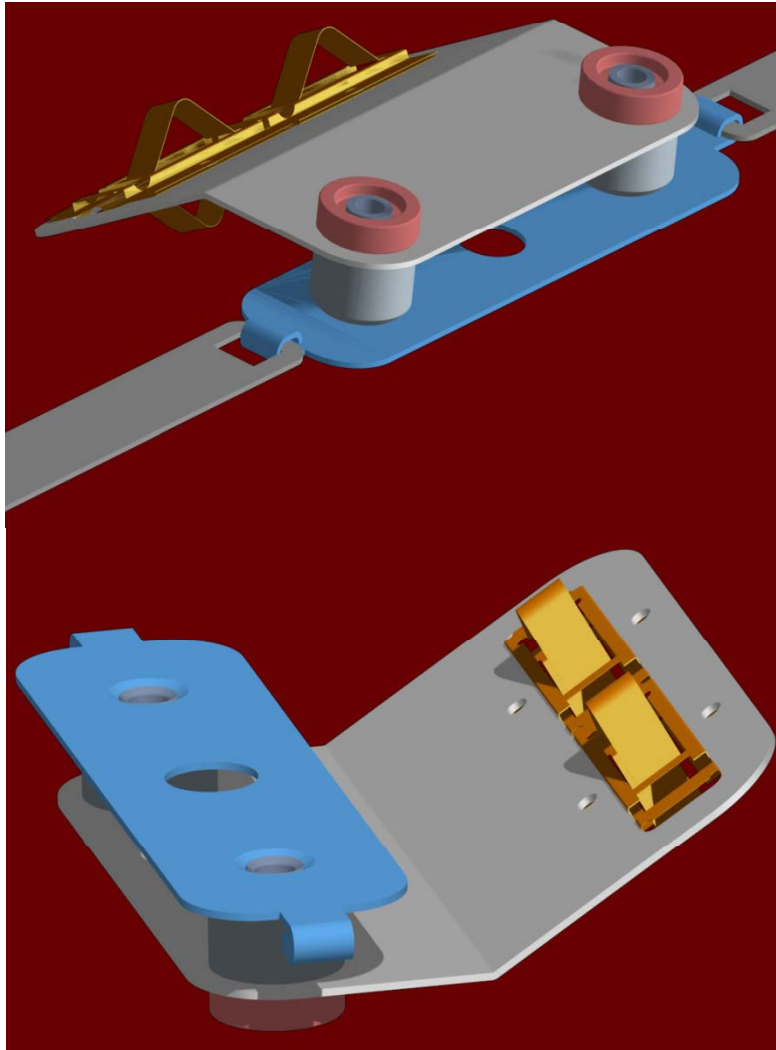

- Designed snubber for vacuum application
- Materials stainless steel and beryllium copper contacts for shorting 10 mm gap
- Procure prototype for test
- Install on spare chamber in building 382 and re-run original experiments with vacuum quality components
- Assembly is press fit and pop-riveted together



Snubber Design

- Snubbers are linked and locked together as they pulled into chamber

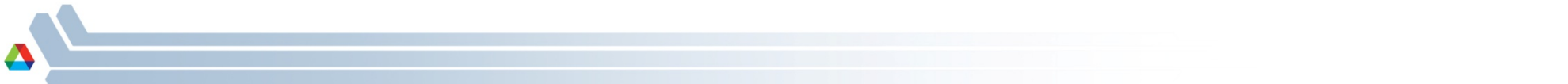
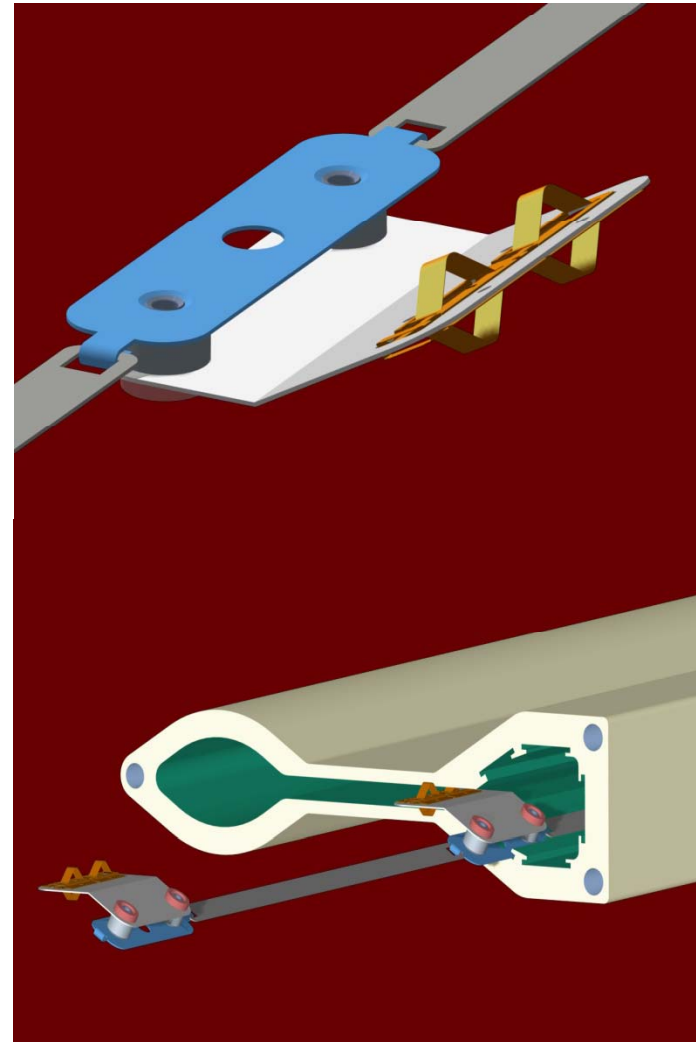
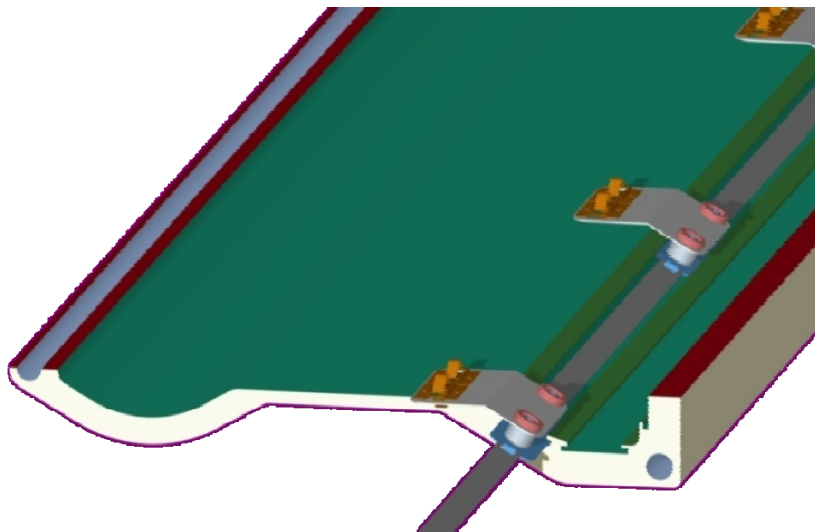

Practice Pull 9 snubber assemblies into curved vacuum chamber



Snubber Installation

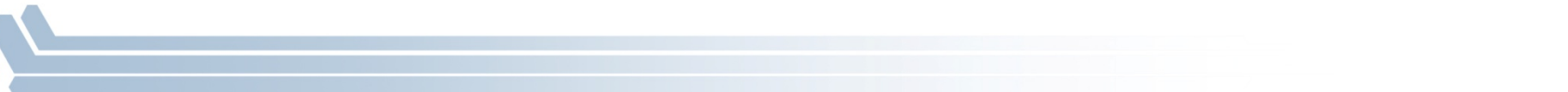
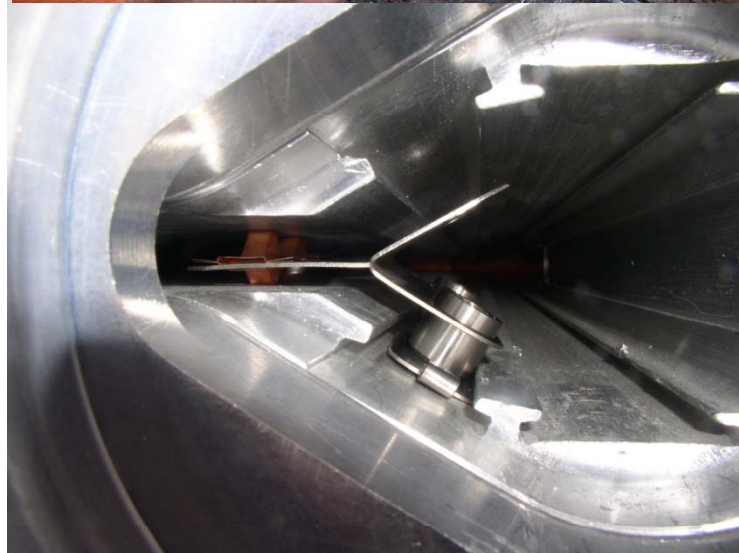

Before Installation of Snubbers

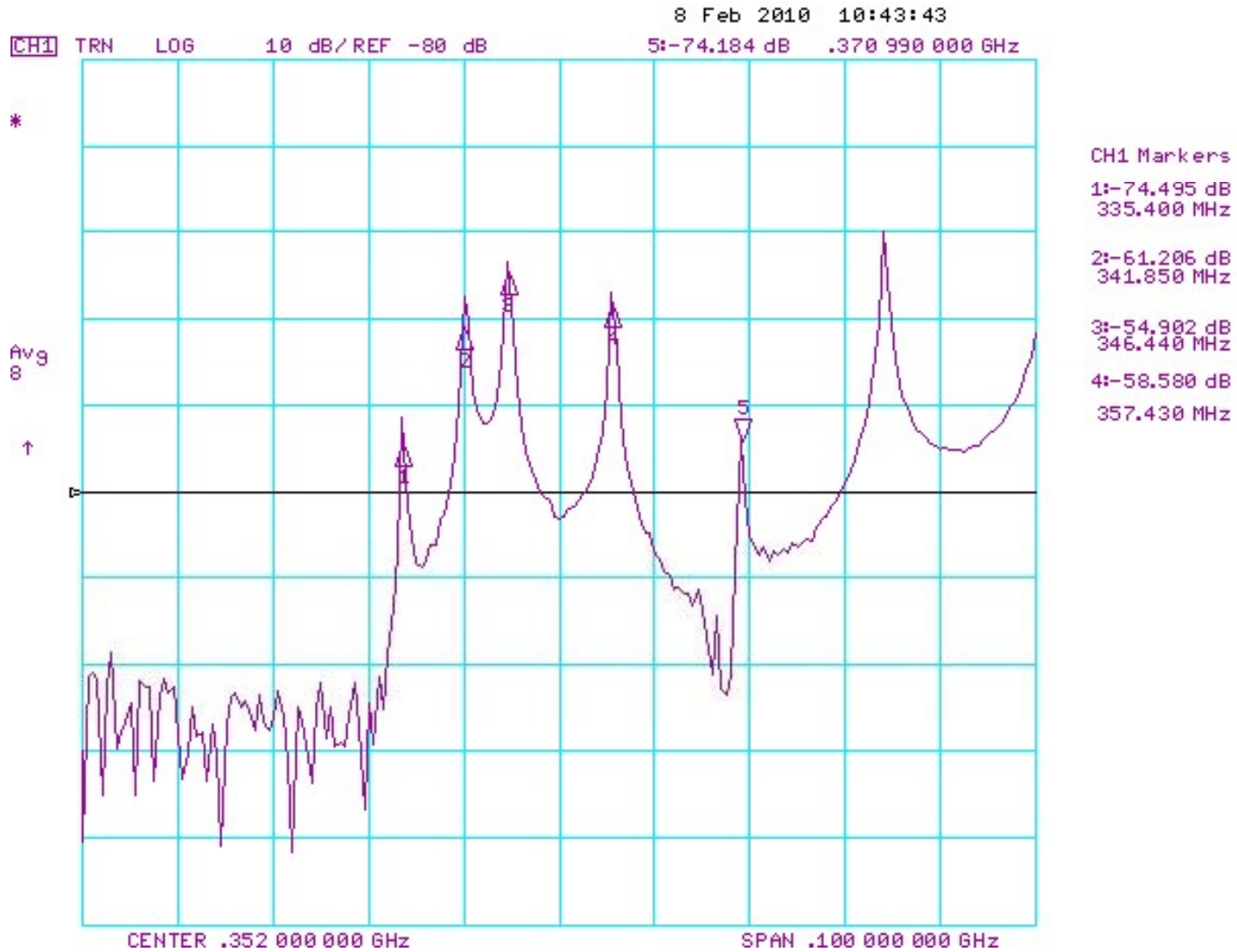

After Installation of 9 Snubbers

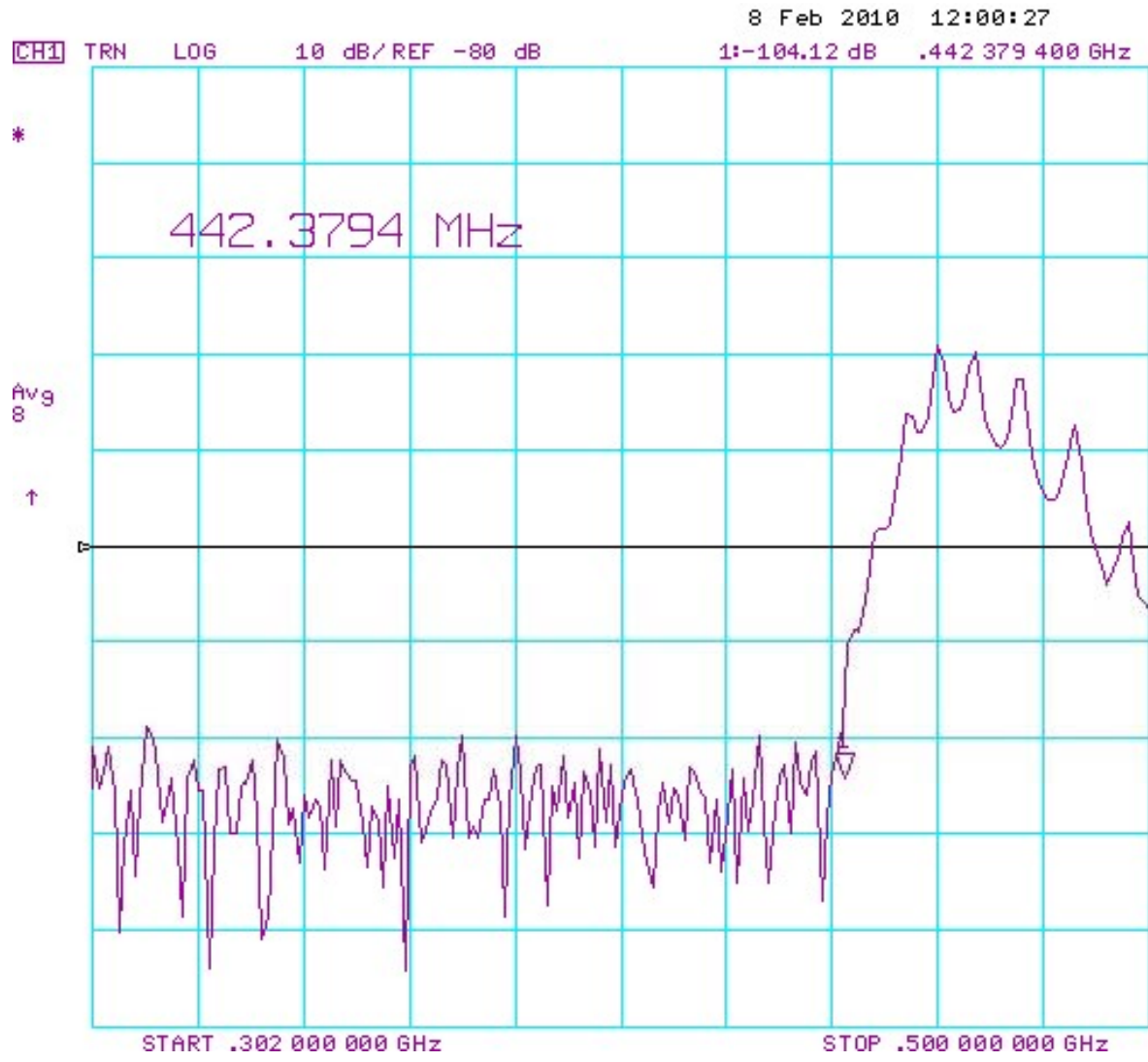

Bench Test Result Summary

- 9 snubber assemblies were successfully pulled into the bench test vacuum chamber
- Simulations and measured data for before and after snubber installation show good correlation and promising results
- Vacuum chamber cut-off frequency shifted from approximately 330 MHz to 440 MHz
- Standard snubber design works well for 7 out of 9 BPMs
- Now the bad news

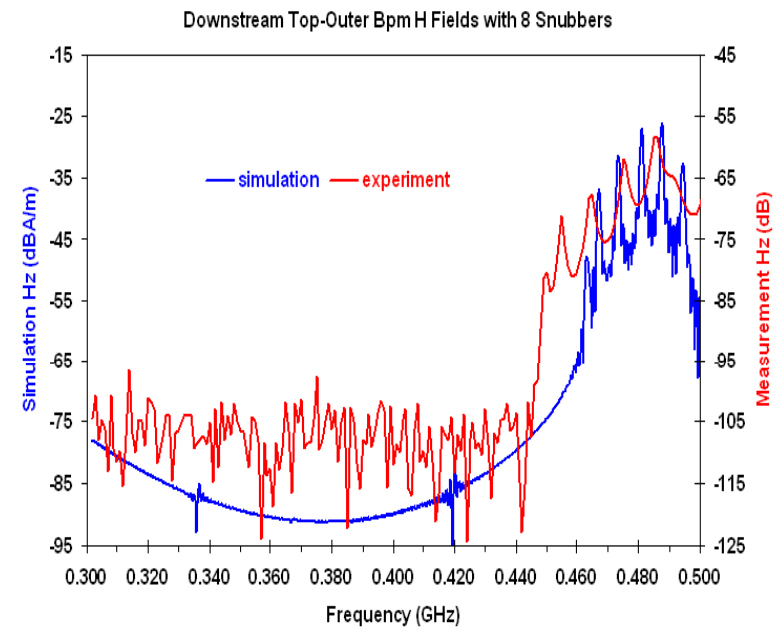
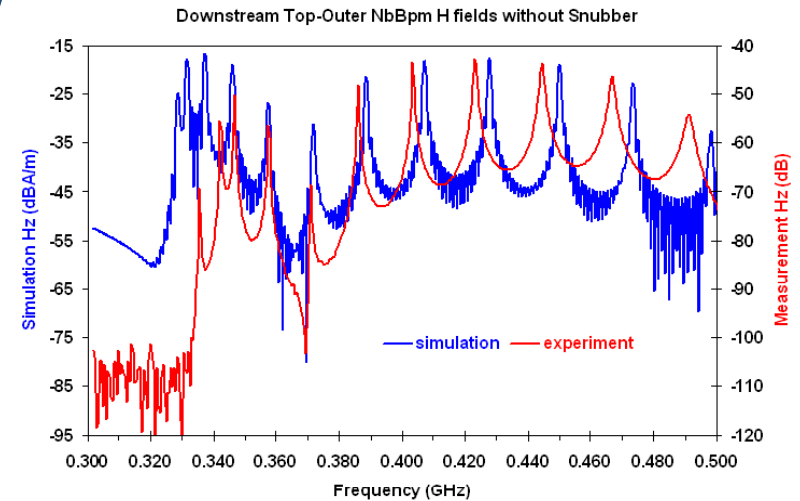

Ray tracing data identifies problems on curved chambers

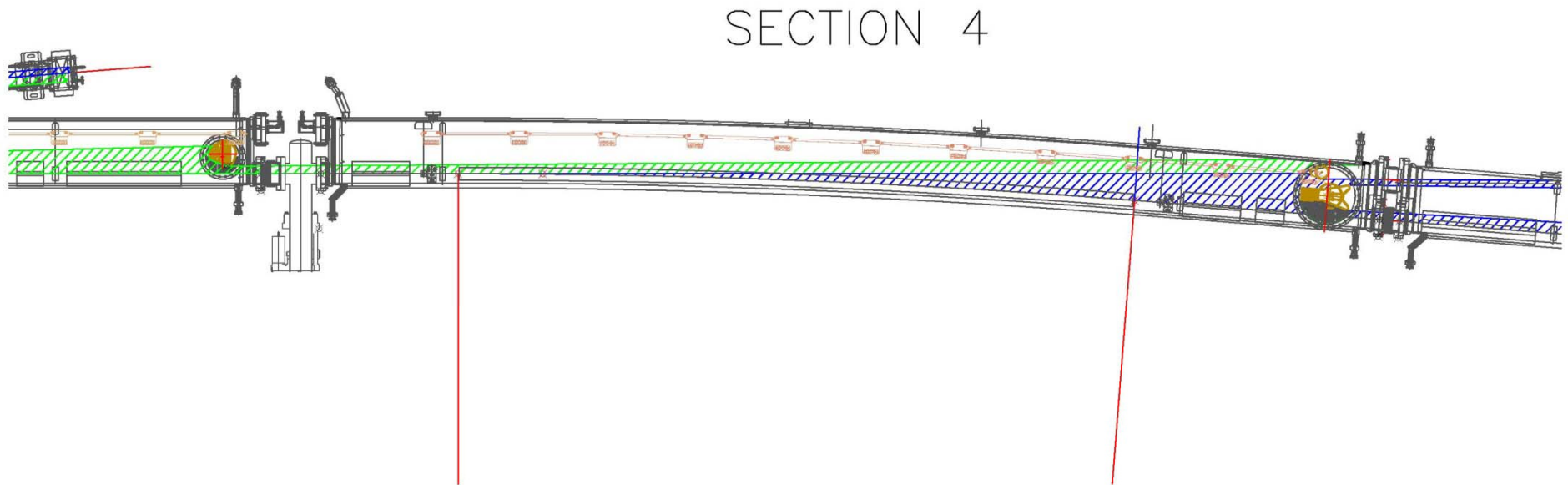

Ray tracing data indicates downstream BPM on curved chambers cannot use standard snubber . Downstream BPMs AP4 and BP3 require new approach to avoid any possibility of x-ray interception



Solutions

- Designed and prototype curved snubber that would avoid x-ray intersection for downstream end of curved chambers
- Optimized installation locations on curved chambers downstream BPMs S29:AP4 and S29:BP3 for best passband (347-357 MHz) using curved snubber

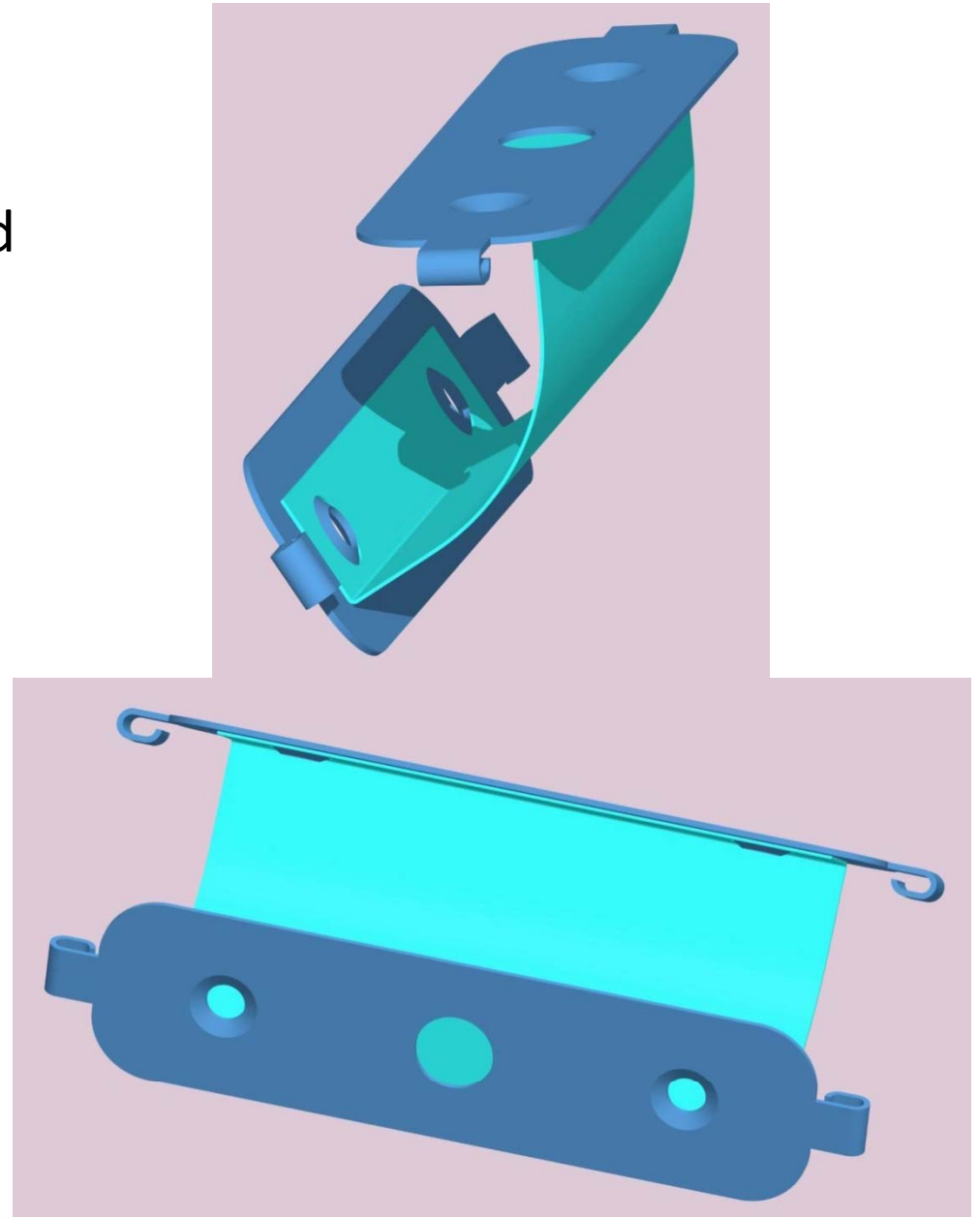

Curved Chamber Solution

➤ The new approach avoids x-ray interception by curving into the anti-chamber

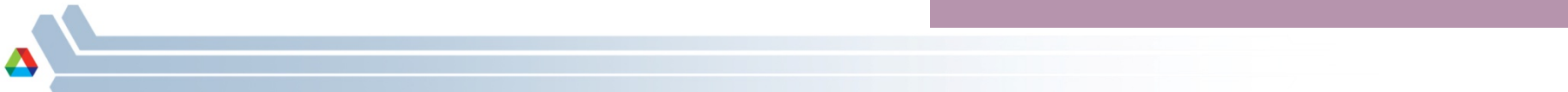
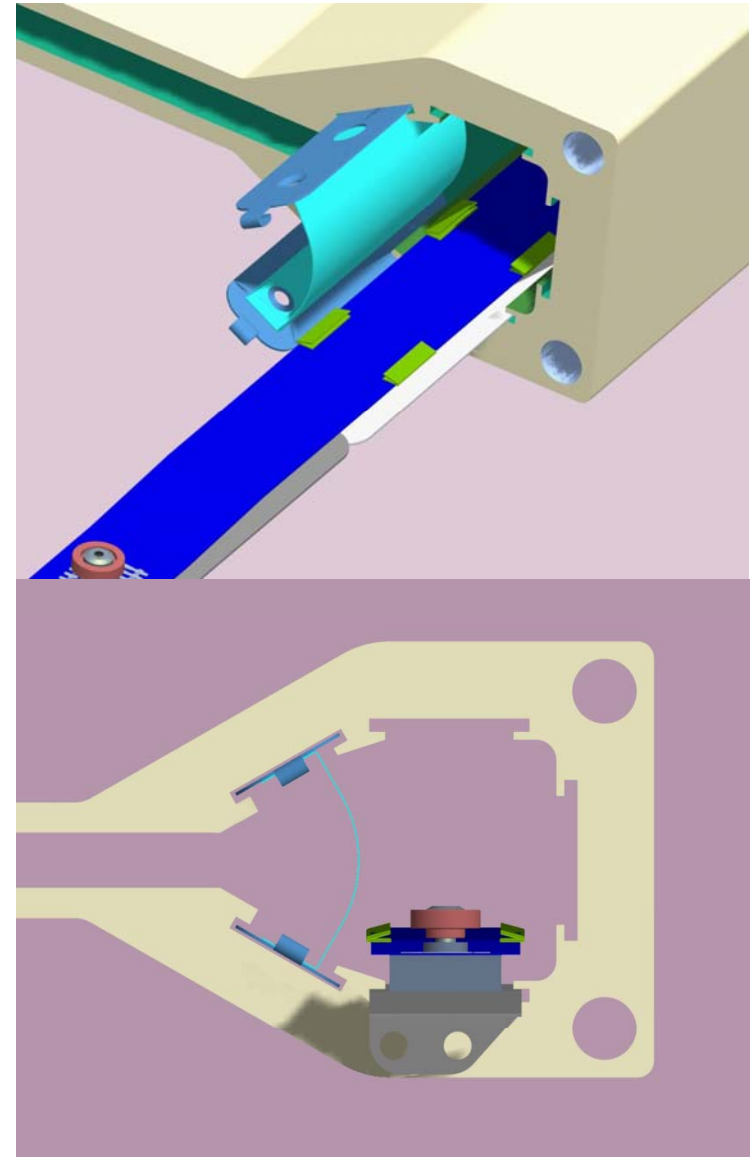
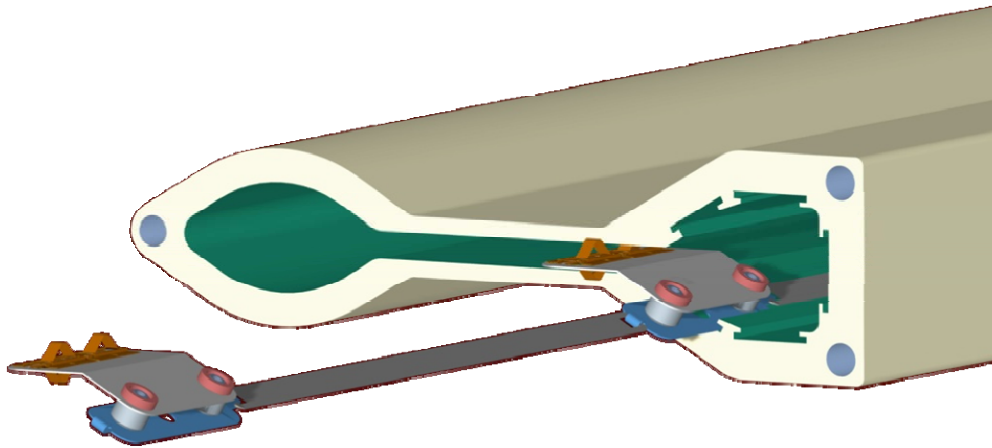

Curved Snubber Installed on Test Chamber

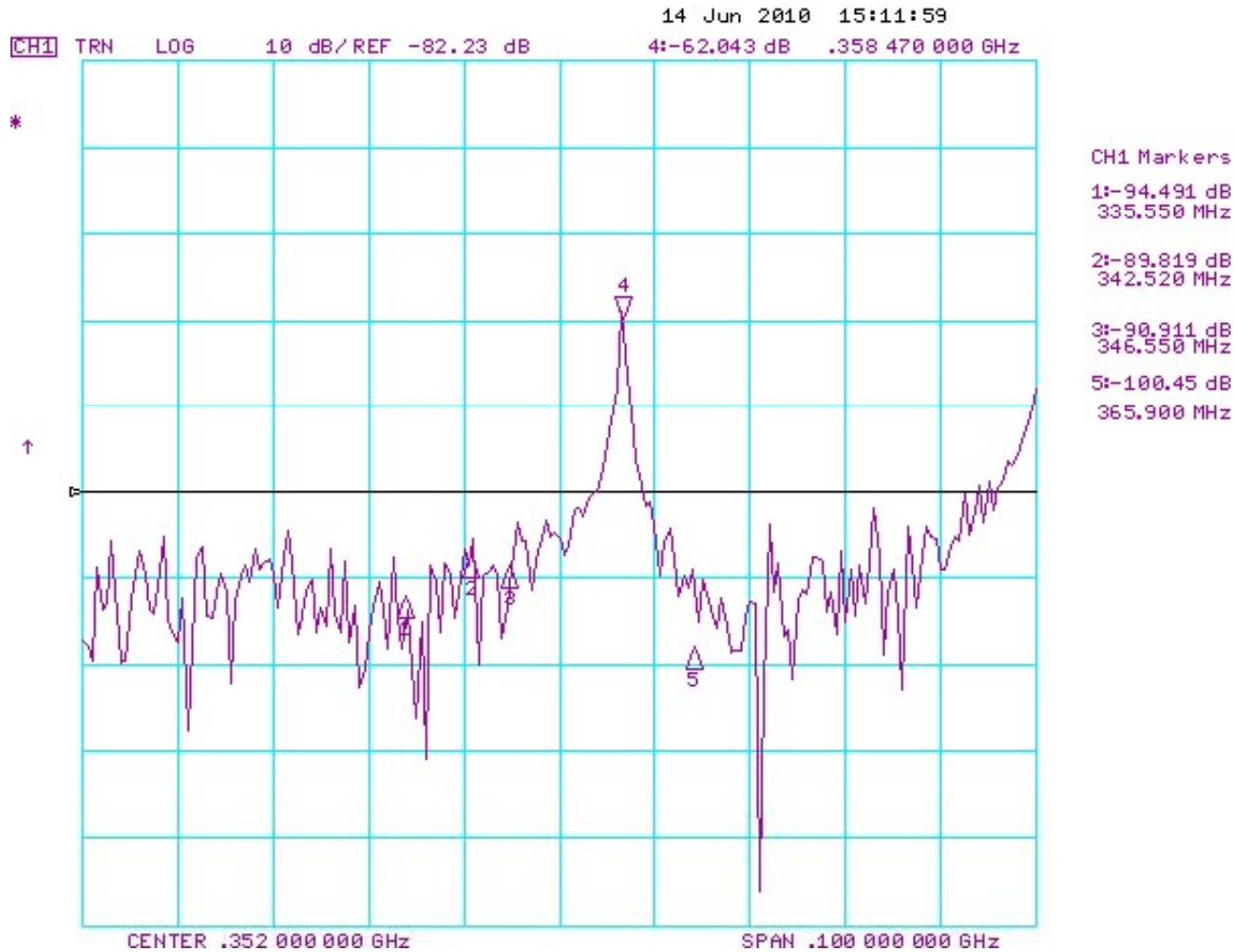

This plot shows the previous measured resonances (marker values) have been suppressed when curved snubbers are installed



Curved Snubber Installed on Test Chamber

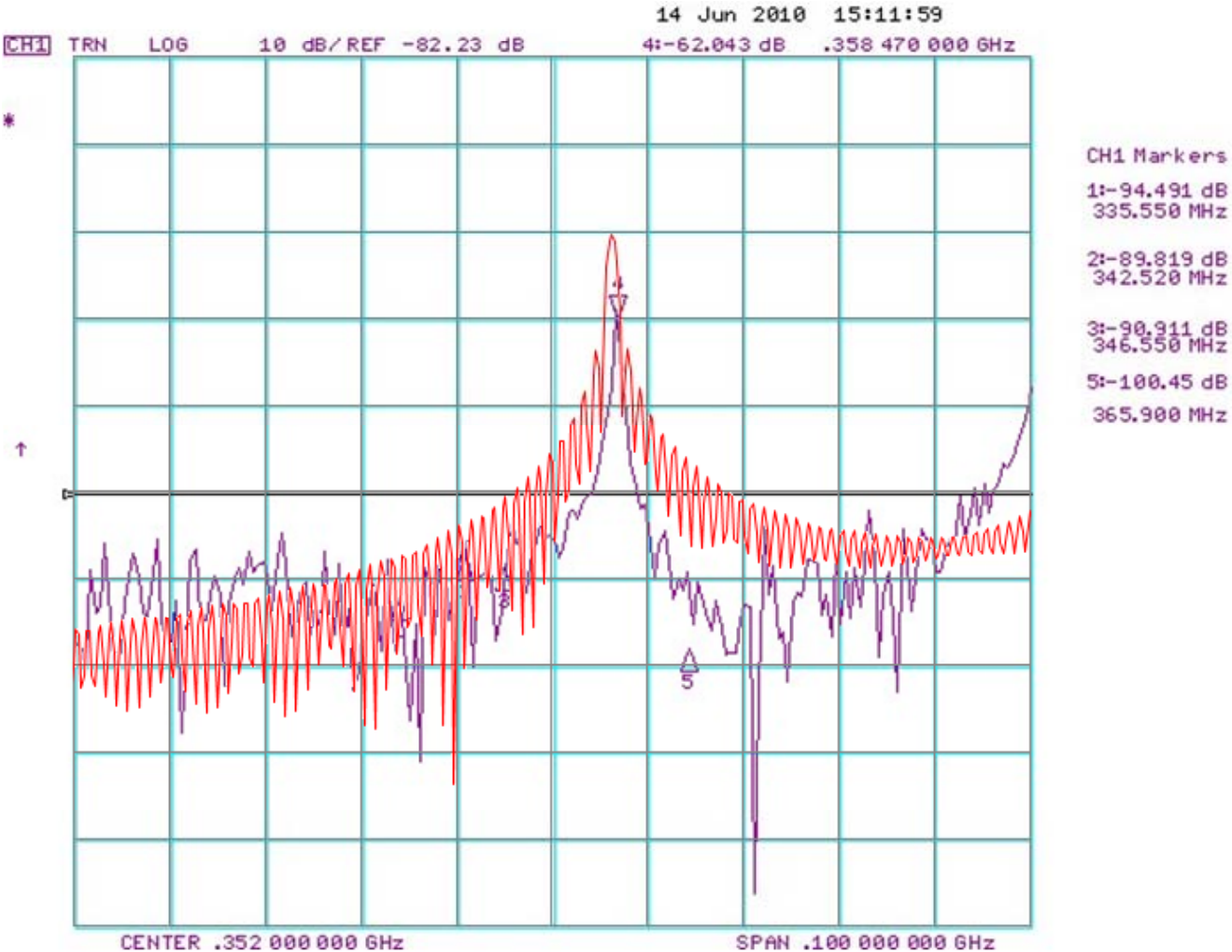

This plot shows the previous measured resonances compared to simulated response in red



Should we proceed with the installation planned for September 2010?

- Is this design Electrically and Mechanically suitable for application?
- Vacuum Compatible?
- Materials?
- Cost Considerations?

➤ July 2010 parts were ordered

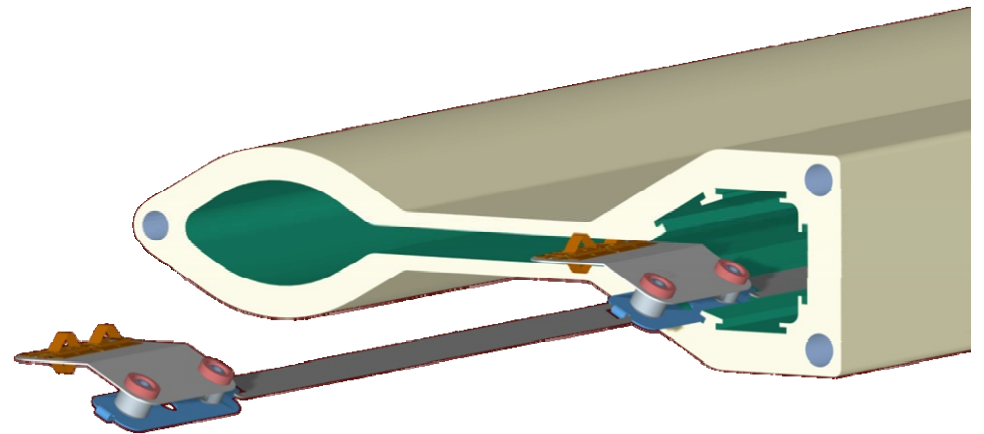

September 2010 Shut-Down

- Installation approved by storage ring manager and vacuum system group
- Drawing package completed
- All parts assembled and cleaned
- Plan all work involving the installation
- Complete installation procedure
- Installation completed by Mom group in one week

Section number	Number of Standard Snubbers/section	Number of "C" type Snubbers/section	Drawing Number
1	9	0	310307-201100
2	8	2	310307-202100
3	*6	0	310307-203100
4	7	2	310307-204100
5	7	0	310307-205100



Sector 30

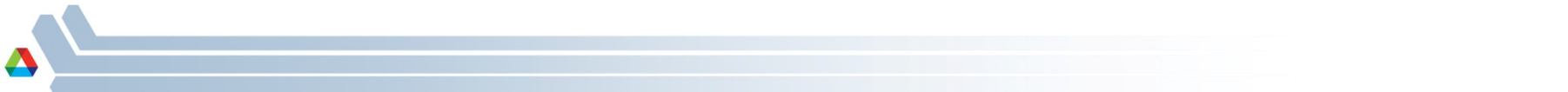
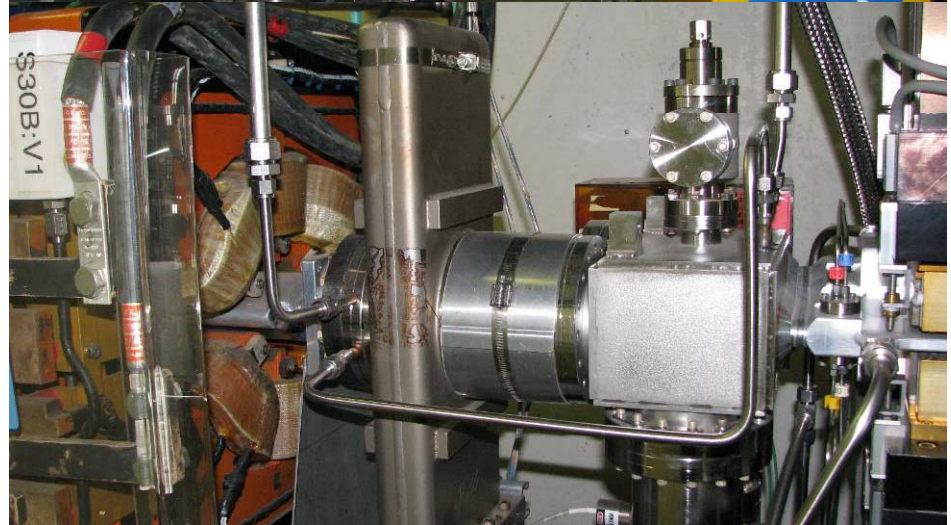
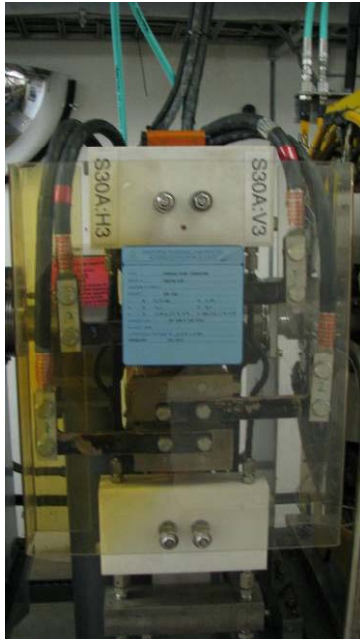

Commissioning S29 Cold Test Measurements

Goals

- Cold test each vacuum chamber before and after installation of snubber system
- Determine if rogue modes are suppressed by cold test measurements resonances in curve chamber
- First measurements of a complete vacuum chamber with getter strips installed
- Launch vertically polarized signals in chamber and measure the BPM button responses
- Verified cut-off to be near 440 MHz after installation
- Verified cold test data with beam test data



S29AP1 & AP2 Before and After Snubber

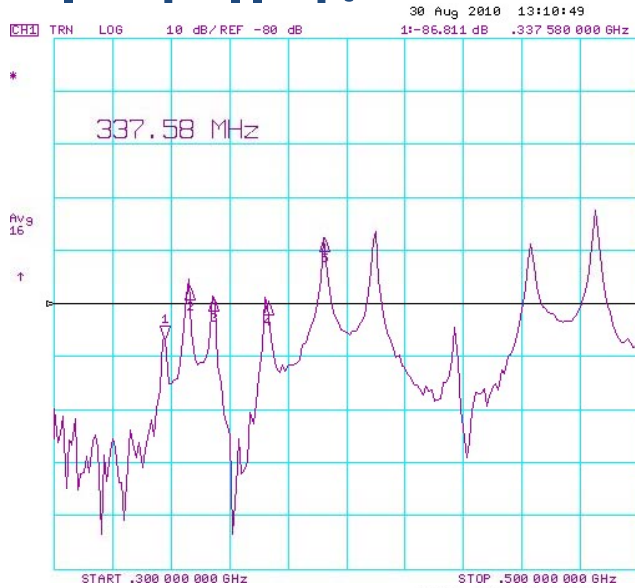

CH1 Markers

21-76.882 dB
346.140 MHz

31-79.111 dB
354.320 MHz

41-79.847 dB
372.700 MHz

51-67.875 dB
392.040 MHz

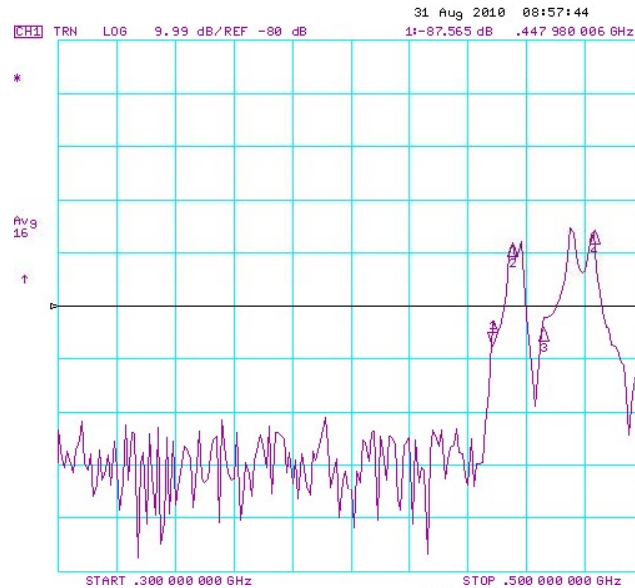

CH1 Markers

21-68.447 dB
454.760 MHz

31-84.230 dB
465.400 MHz

41-66.056 dB
482.740 MHz

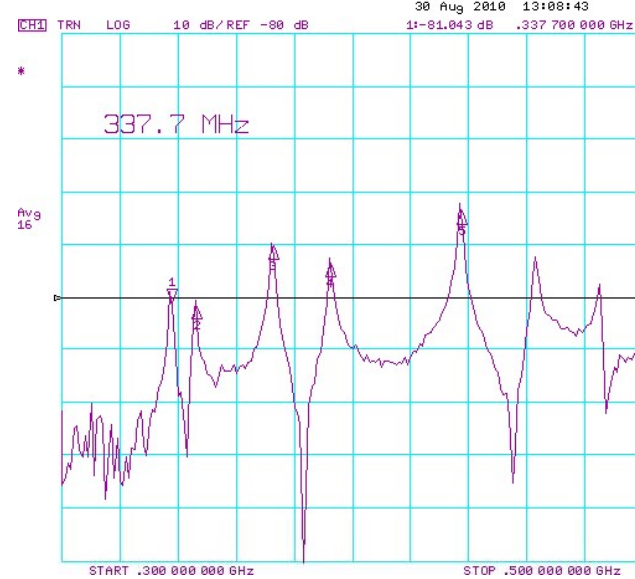

CH1 Markers

21-82.005 dB
346.160 MHz

31-70.394 dB
372.300 MHz

41-73.732 dB
391.800 MHz

51-63.925 dB
437.280 MHz

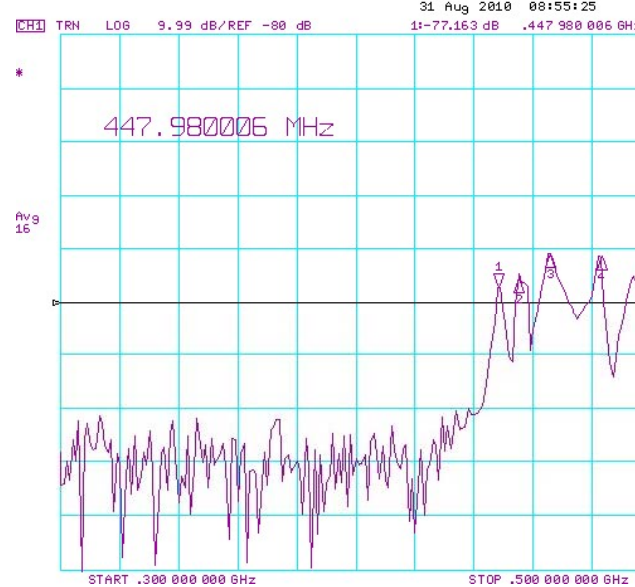

CH1 Markers

21-75.909 dB
454.760 MHz

31-71.046 dB
465.400 MHz

41-71.432 dB
482.740 MHz



S29AP3 & AP4 Before and After Snubber Installation

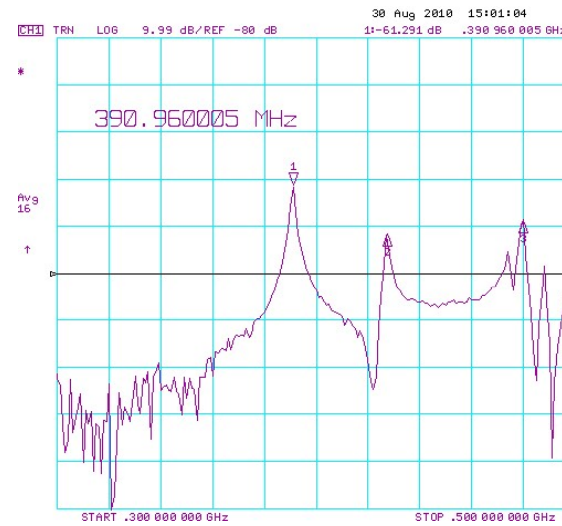
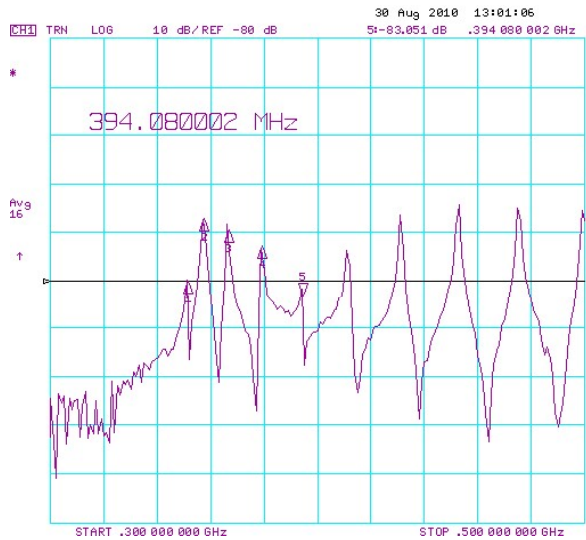
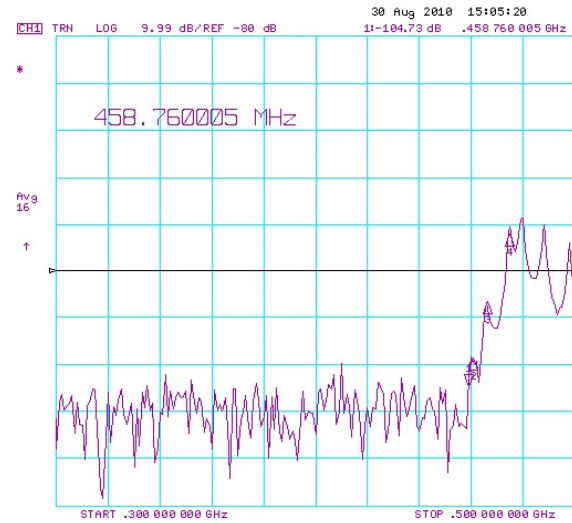
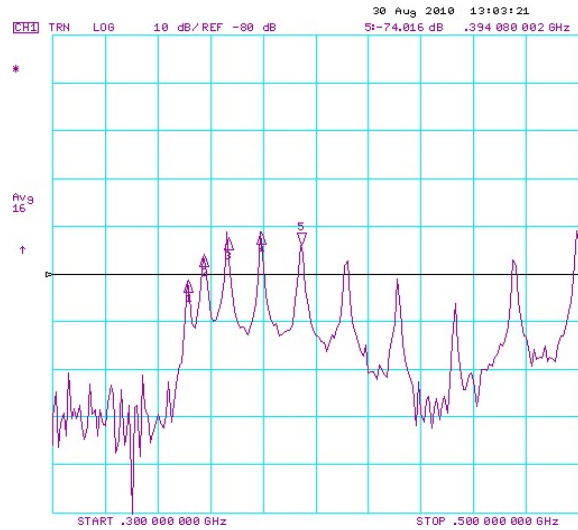

S29BP5 Before and After Snubber Installation

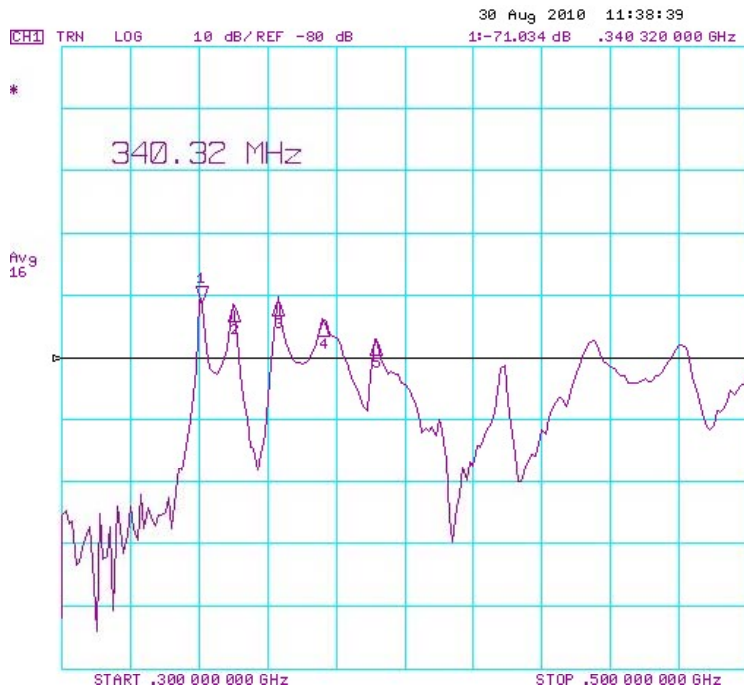

CH1 Markers
2:-71.903 dB
349.820 MHz
3:-70.793 dB
362.840 MHz
4:-74.223 dB
375.780 MHz
5:-77.128 dB
391.200 MHz

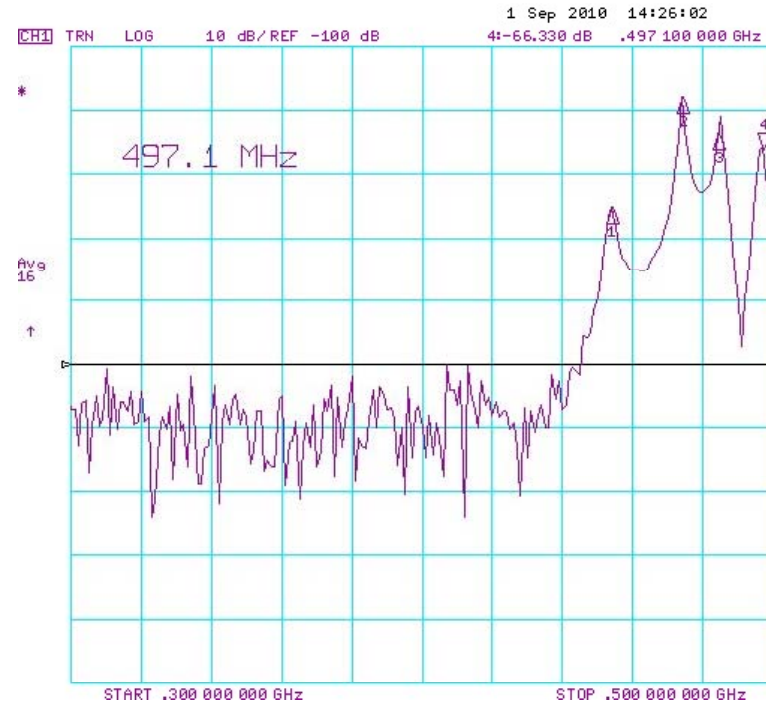

CH1 Markers
1:-75.414 dB
453.800 MHz
2:-58.105 dB
473.980 MHz
3:-63.840 dB
484.440 MHz

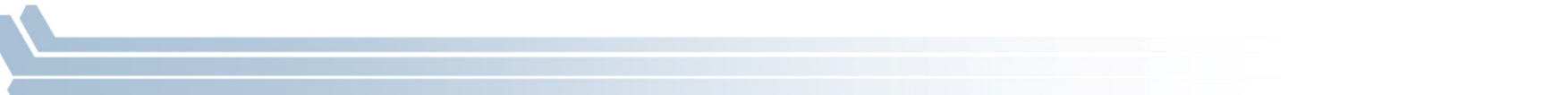

S29BP4 & BP3 Before and After Snubber Installation

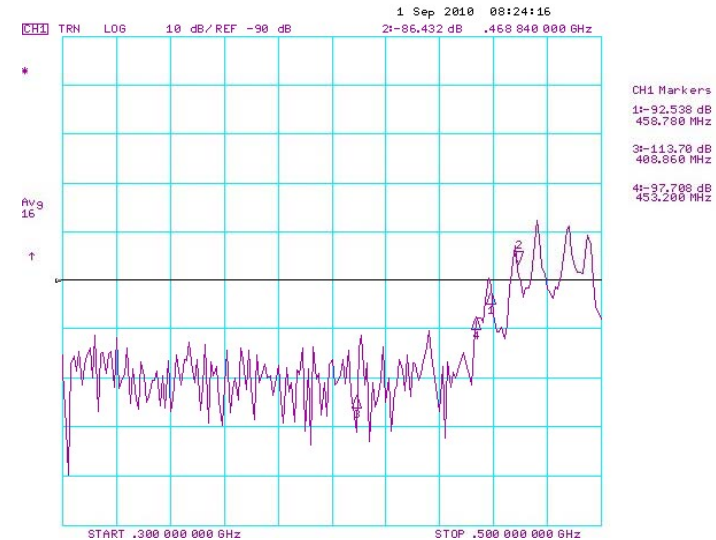
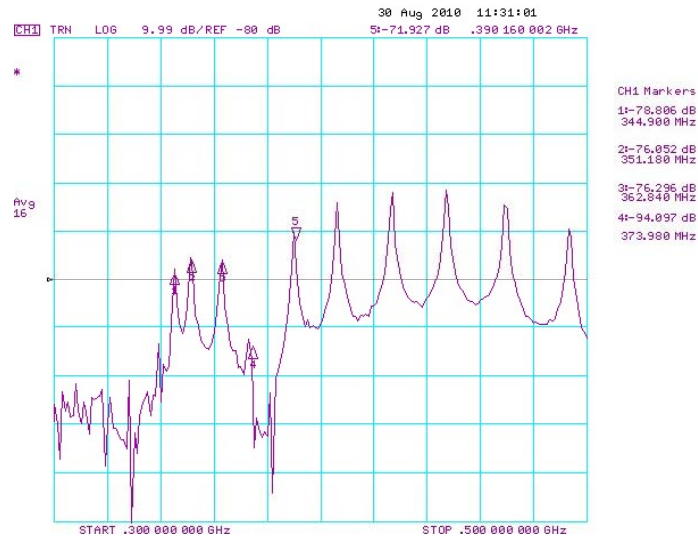
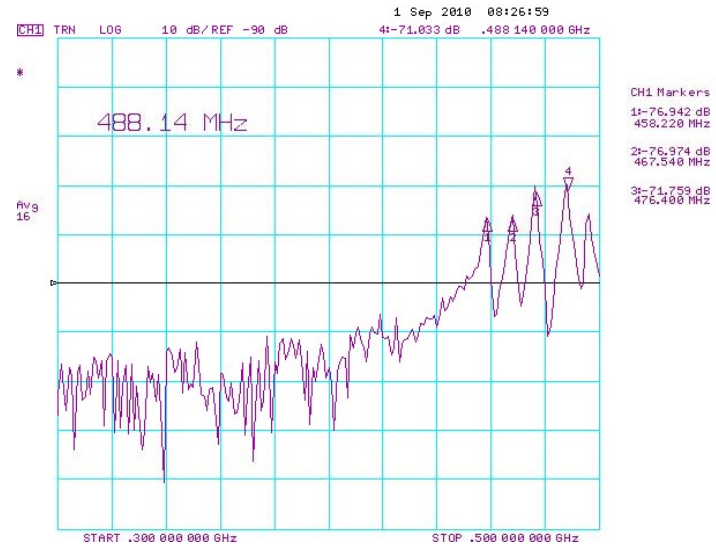
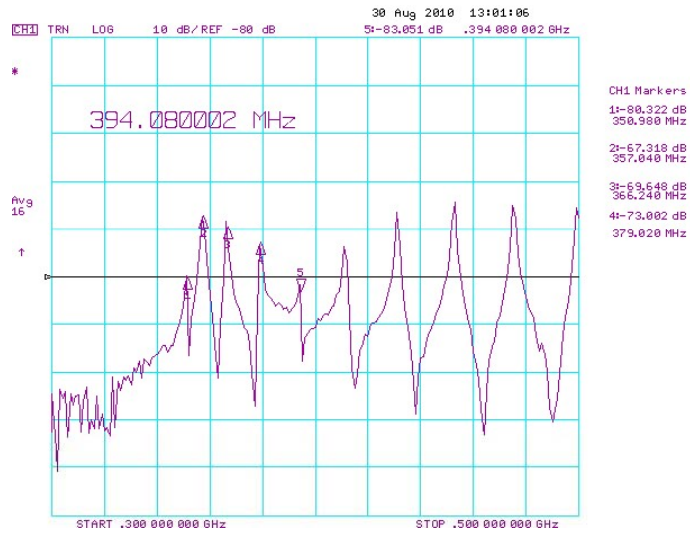

S29BP2 & BP1 Before and After Snubber Installation

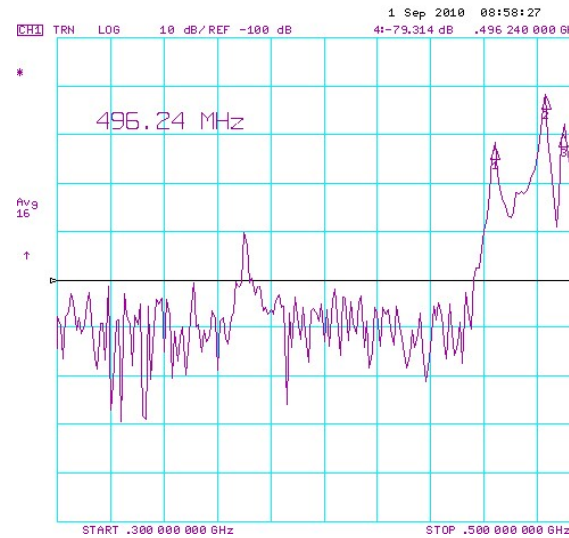
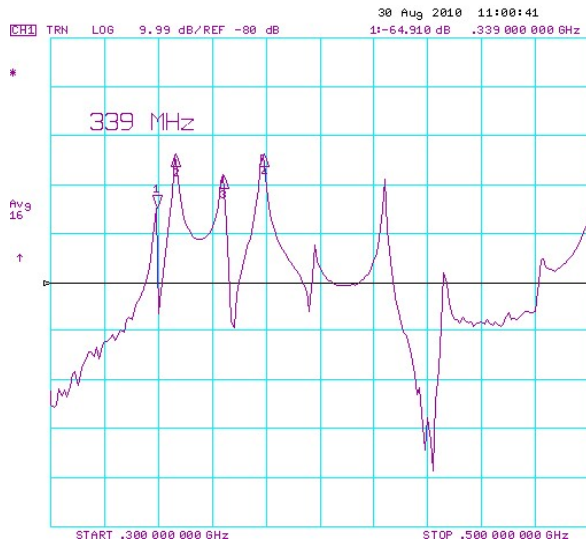
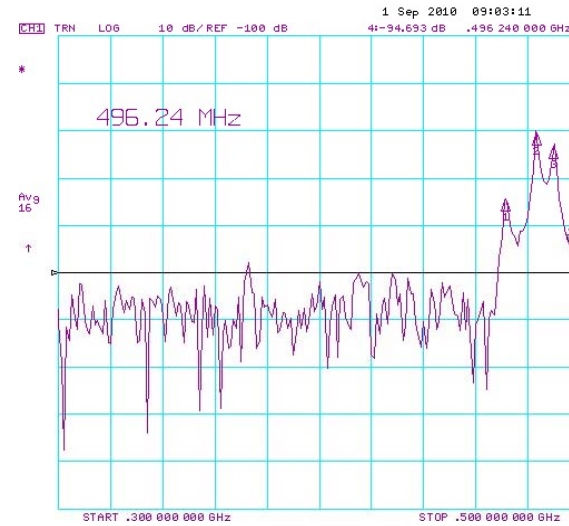
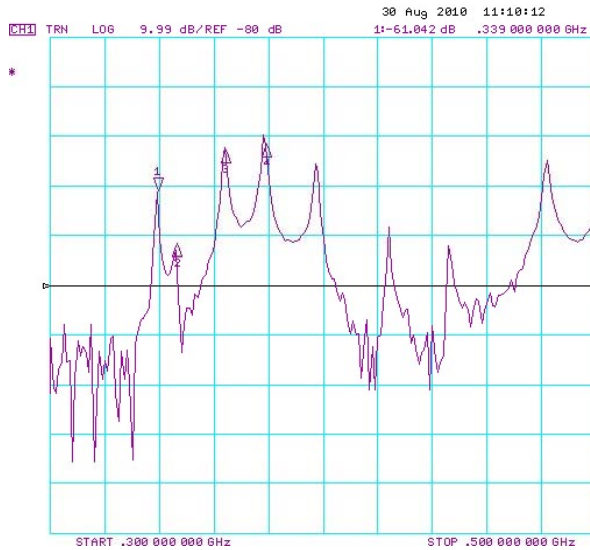

Beam Study Conducted September 30, 2010

Goal

- Collected vsa spectral data for BPMs in S29 which had mode snubbers installed
- Theoretically the single-bunch spectrum when measured by a capacitive pick-up is the convolution of the single bunch spectrum, button response, filter response and cable attenuation.
- In general the response should have a smooth bell-shaped curved similar to the output bandpass filter of the filter comparator



BPM Front-End Filter Comparator

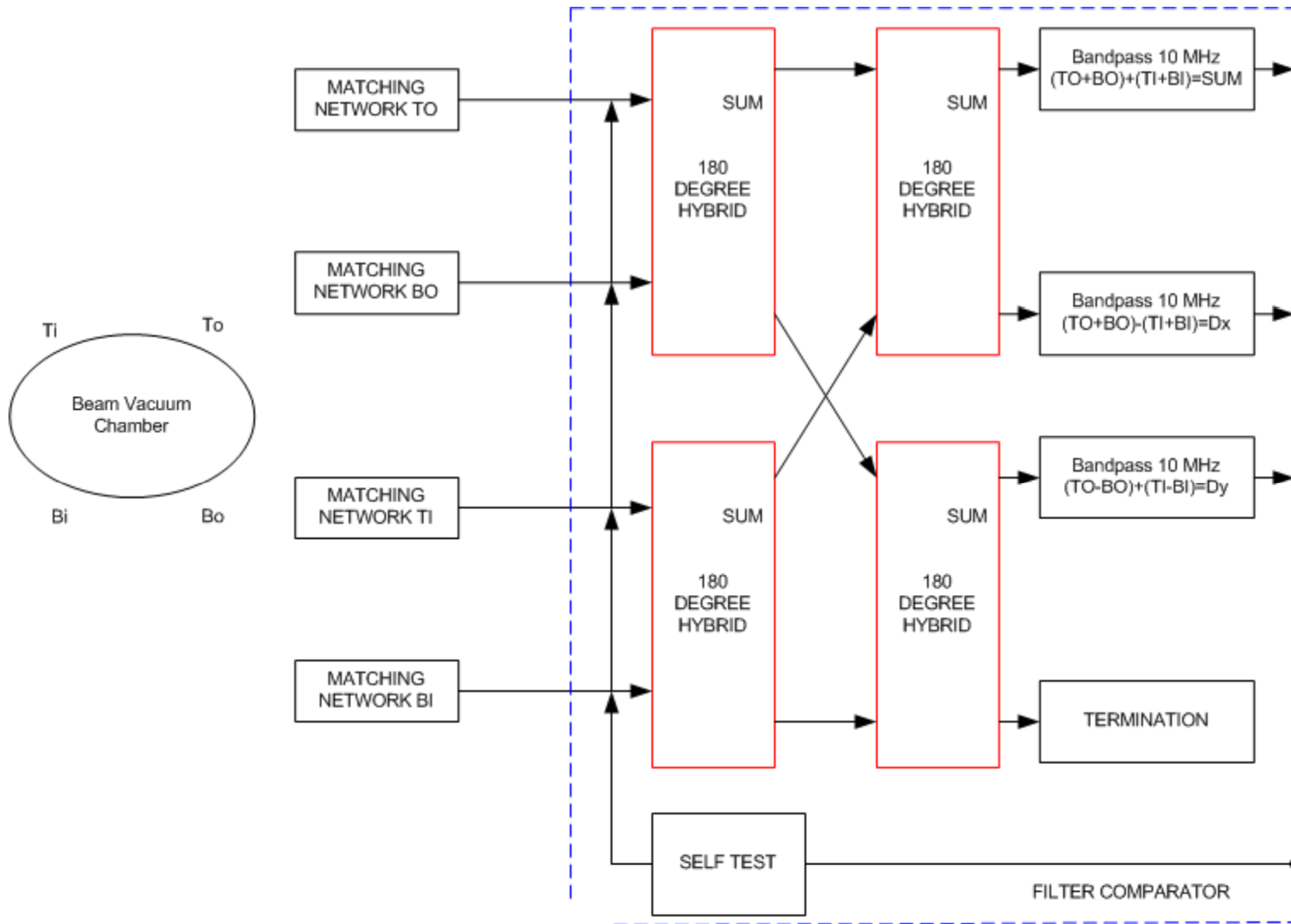

Typical Rogue Microwave Problem

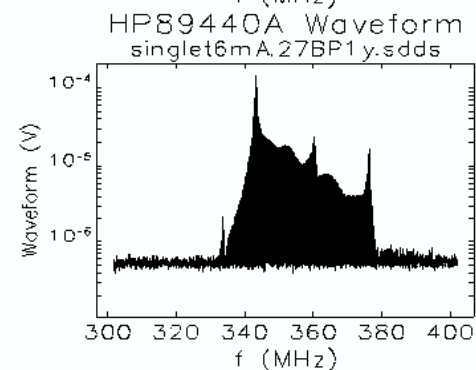
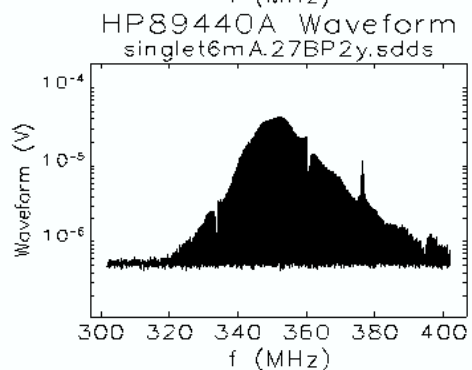
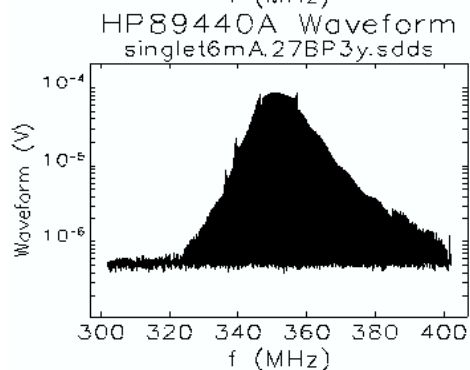
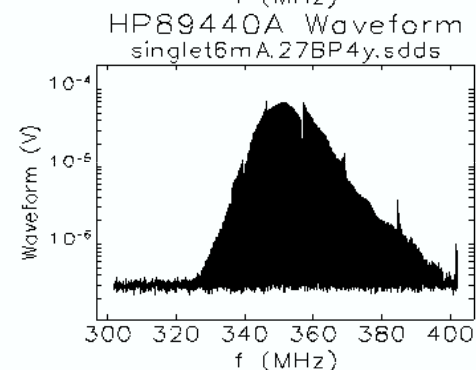
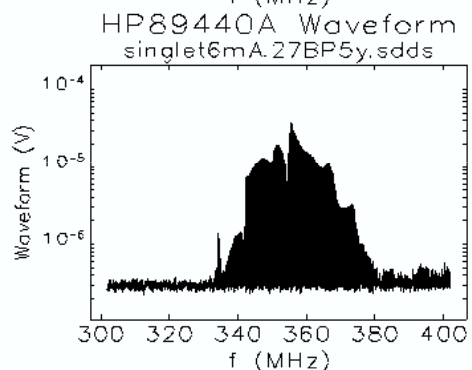
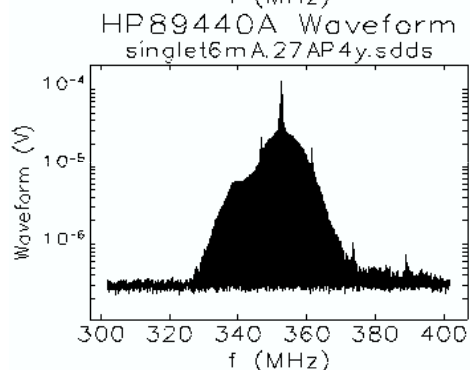
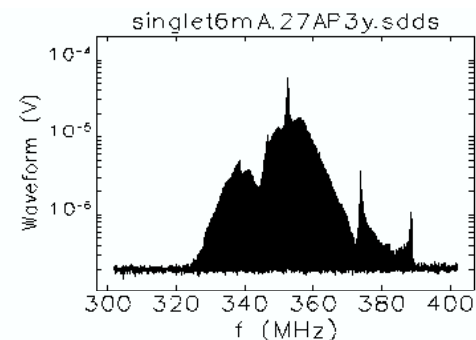
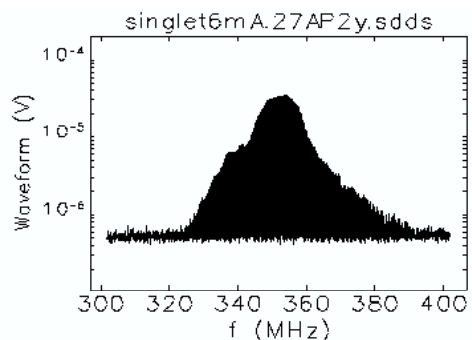
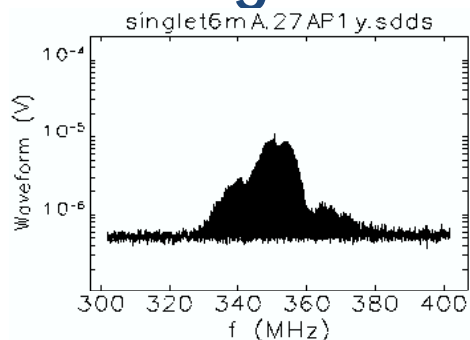

HP89440A Waveform

HP89440A Waveform

HP89440A Waveform

Filter Comparator vertical output response to single bunch



After Installation of Snubbers Suppression System in Sector 29

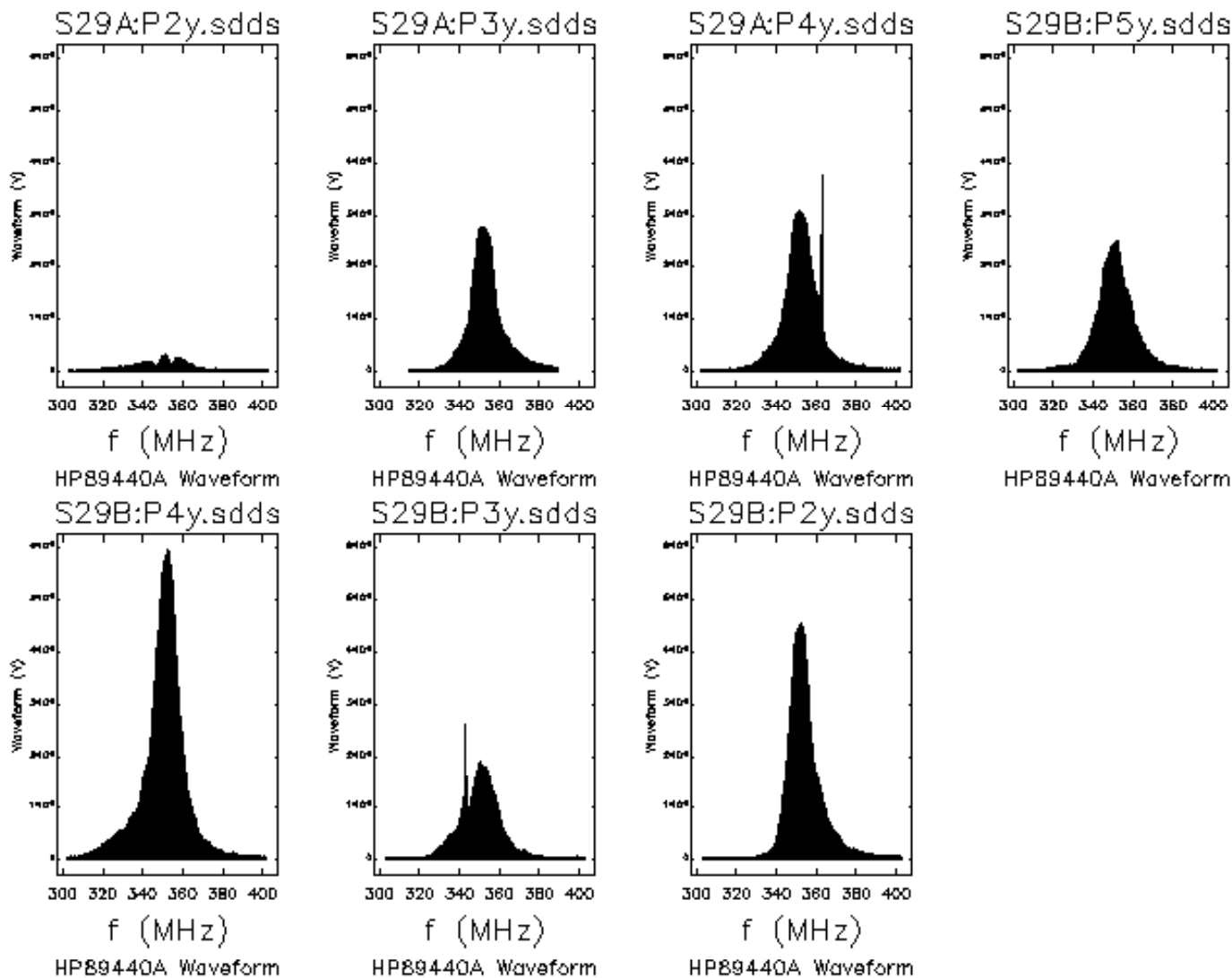

Filter Comparator vertical output response to single bunch



Summary

- ✓ The snubber design will reduce or eliminate the trapped TE mode resonances in the APS storage ring vacuum chambers
- ✓ The bpms closest to the crotch absorbers, S29AP4y and S29BP3y show one resonance line each, at 362.8 MHz for AP4 and 343 MHz on BP3. Other than those two lines all other monopulse BPMs are now clean
- ✓ A more robust snubber design or a stick absorber that is water cooled could be implemented if required on AP4 and BP3
- ✓ A narrow band filter on the BPM frontend is also being considered for these two BPMs if required



Acknowledgement

Glenn Decker, John Hoyt, Xiang Sun, Bingxin Yang

This work is the collective effort of many individuals and multiple groups within ANL

Thank You

