

# Design and Analysis of Accelerator Vacuum Systems with SynRad and MolFlow+

Jason Carter

Mechanical Engineer, AES-MED Group

[jacarter@anl.gov](mailto:jacarter@anl.gov), LOM 437E008, 2-8331

# Outline

- Design of accelerator vacuum systems
  - MolFlow+ and SynRad overview
- SuperKEKB upgrade
  - Overview and project goals
  - Modeling vacuum system geometry
  - Synchrotron flux in SynRad
  - Outgassing and UHV pressures in MolFlow+
  - Study of results
- APS-Upgrade, design in progress
  - Background and project goals
  - Modeling and simulations
  - Study of results
- Conclusions

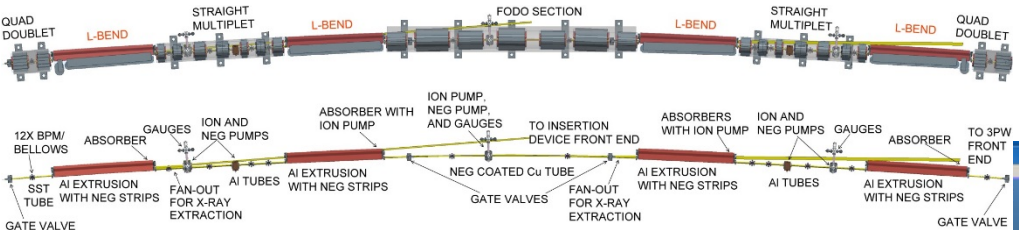
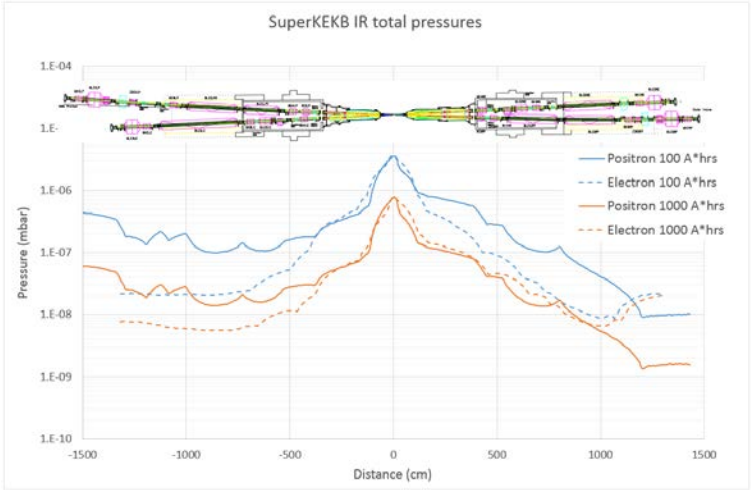
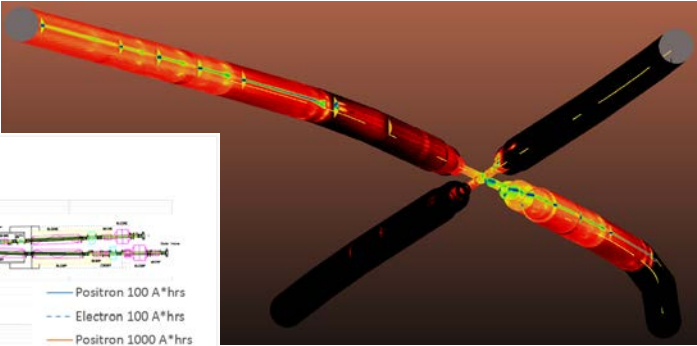

# Accelerator Vacuum Systems

- Travelling particles such as electrons and positrons within accelerator vacuum systems, release synchrotron radiation when their paths are bent in a magnetic field
- This radiation must be accounted for by being passed on to a user or intercepted in a system of shielding at absorbers or along chamber walls
- Problematic from a vacuum system perspective as it becomes the source for the highest gas loads and highest pressures

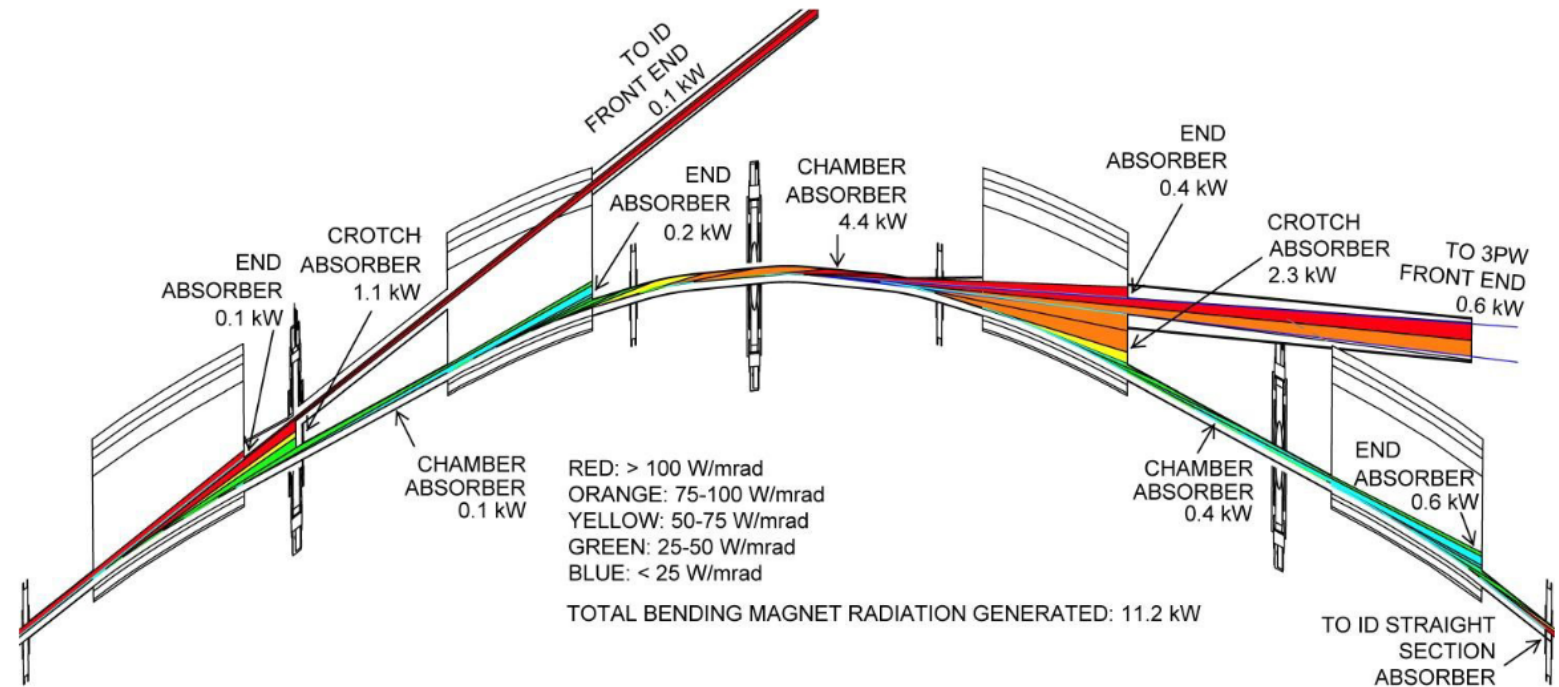
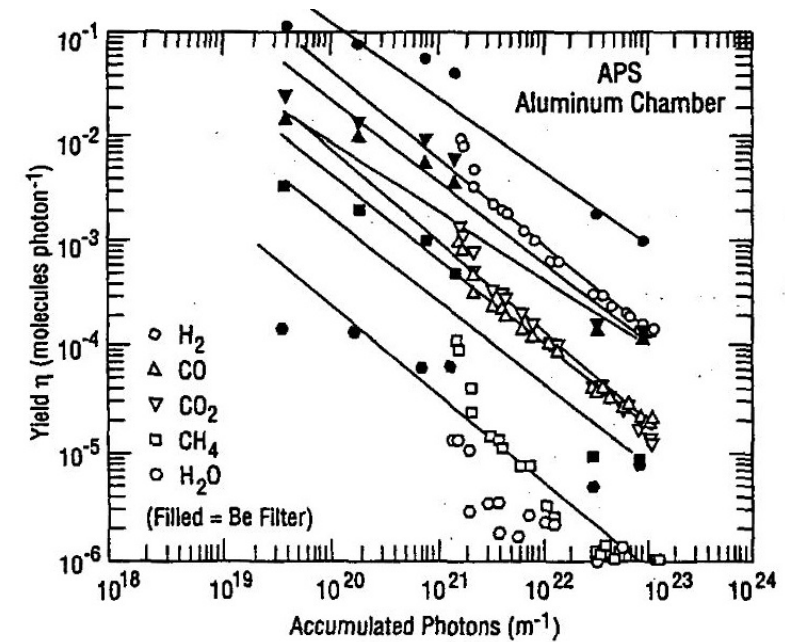

Figure 4: Distribution of bending magnet radiation for a typical storage ring sector.

Top level synchrotron radiation ray trace in one sector of APS-U storage ring concept

# Photon stimulated desorption

- Radiation induced gas loads occur through a process called photon stimulated desorption (PSD)
  - PSD outgassing is highest where photon densities are the highest
  - Exact outgassing rates are non-linear as surfaces are known to clean up with increased photon accumulation
  - Surface scattering of photons leads to irradiation of all surfaces



PSD measurement results for aluminum chamber with downward trend indicating surface conditioning

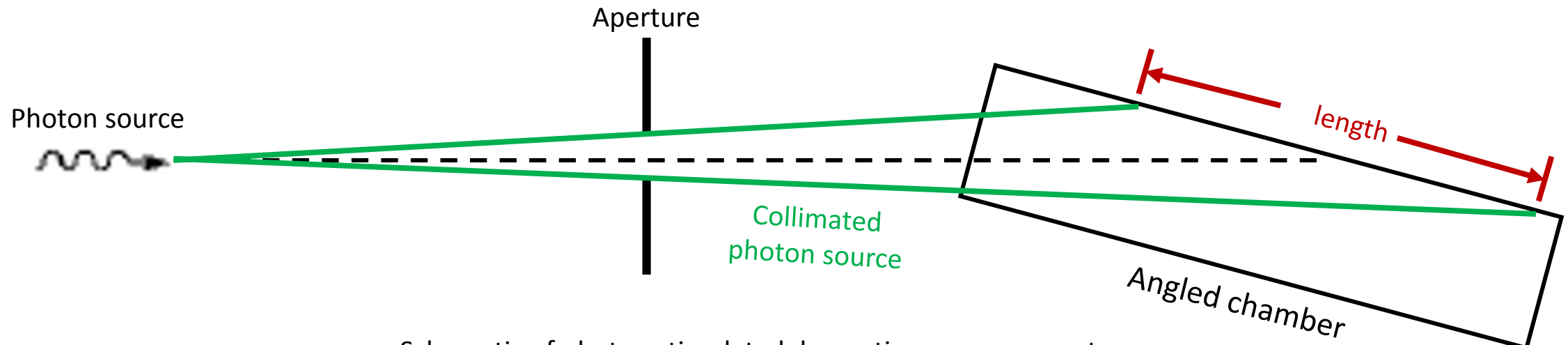

# Accelerator Vacuum System Design

- Low pressure design targets are set to achieve:
  - Increased beam lifetimes
  - Reduced electron cloud
- Vacuum systems are designed to reach low pressures within larger system constraints. These include:
  - Project costs
  - Magnet lattice and geometry dictating quantity and location of pumps and photon absorbers
  - Magnet gaps dictating chamber apertures and pumping options

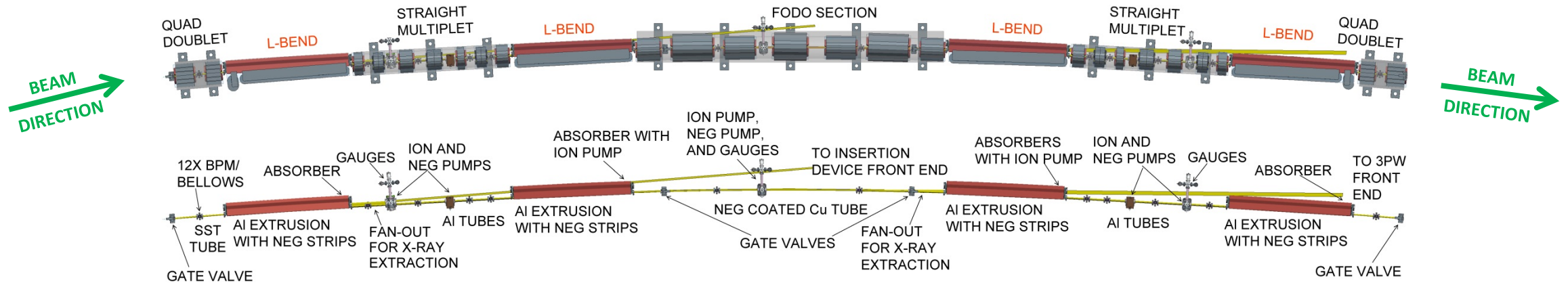

Magnet lattice (top) and vacuum system (bottom) for a typical sector of APS-Upgrade storage ring

# Modeling vacuum systems

- Pressures must be predicted in order to evaluate vacuum system design
  - Pressures assumed in the molecular flow regime
  - For chamber apertures of a few centimeters, this means pressures from  $10^{-3}$  to  $10^{-12}$  mbar, reasonable for accelerators
- Pressure,  $P$ , is a measurement of the gas load,  $Q$ , and the effective pumping speed,  $S_{eff}$ , at a location
  - Effective pumping speed is limited by the conductance,  $C$
- A system of vacuum elements can be treated analogous to an electrical network
- Pumping speeds are generally well understood
- **Conductance** and **gas loads** are less understood and will lead us to explore SynRad and MolFlow+...

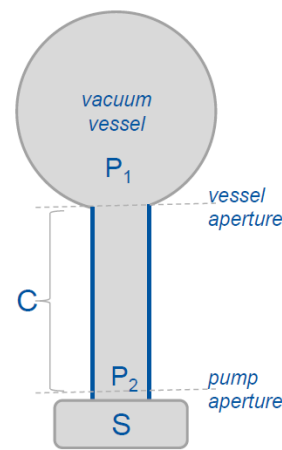

$$Q = C_1(P_1 - P_2) = SP_2 = S_{eff}P_1$$

$$\frac{1}{S_{eff}} = \frac{1}{S} + \frac{1}{C}$$

Pressure in a simplified vessel

$P$  = pressure,  $S$  = pumping speed,  $Q$  = gas load,  $C$  = conductance

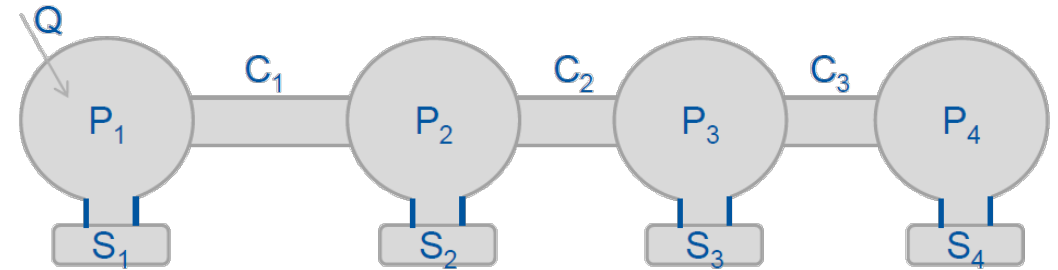

Flux balance at the connexions (node analysis):

$$\left\{ \begin{array}{l} Q = P_1 S_1 + C_1(P_1 - P_2) \\ C_1(P_1 - P_2) = C_2(P_2 - P_3) + P_2 S_2 \\ C_2(P_2 - P_3) = C_3(P_3 - P_4) + P_3 S_3 \\ C_3(P_3 - P_4) = P_4 S_4 \end{array} \right.$$

Simplified vacuum system model

Figures from P. Chiggiato – Vacuum Technology for Particle Accelerators, JUAS 2013

# Conductance

- In the molecular flow regime, the net flux of molecules from one point to another is proportional to the pressure drop
  - $Q = C(P_1 - P_2)$
- Conductance only depends on **molecular speed** and vacuum system **geometry**
- In the simplest case of gas flow through an aperture, conductance only depends on the molecular speed
- Equations exist for simple geometries such as cylindrical tubes
  - $C_{\text{tube}} \text{ (L/s)} = 12 * D^3 / L$ , lengths in cms
- For more complex gas flow restrictions, the transmission probability is introduced
  - Only depends on geometry
  - Calculated analytically only for simple geometries

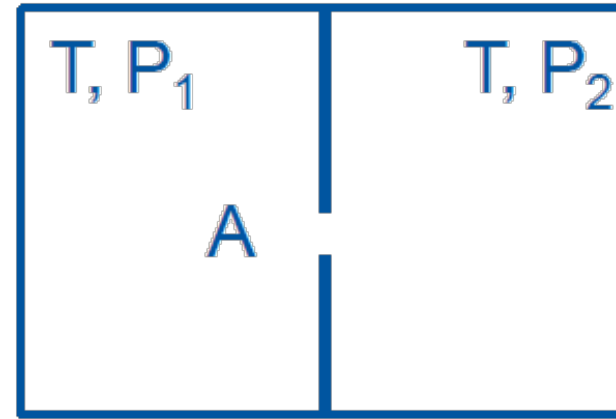

$$C = \frac{1}{4} A \langle v \rangle \propto \sqrt{\frac{T}{m}}$$

Gas flow through and aperture



$$C = C' A_1 \tau_{1 \rightarrow 2}$$

Gas flow with more complex restrictions

# MolFlow+ for complex conductances

- For more complicated geometry, Test-Particle Monte Carlo (TPMC) methods are required
  - Generate random molecules according to the cosine distribution
  - Follow their traces until they reach a sink
  - Many simulated molecules are needed to reduce statistical scattering
- MolFlow+ is a 3D TPMC program created at CERN

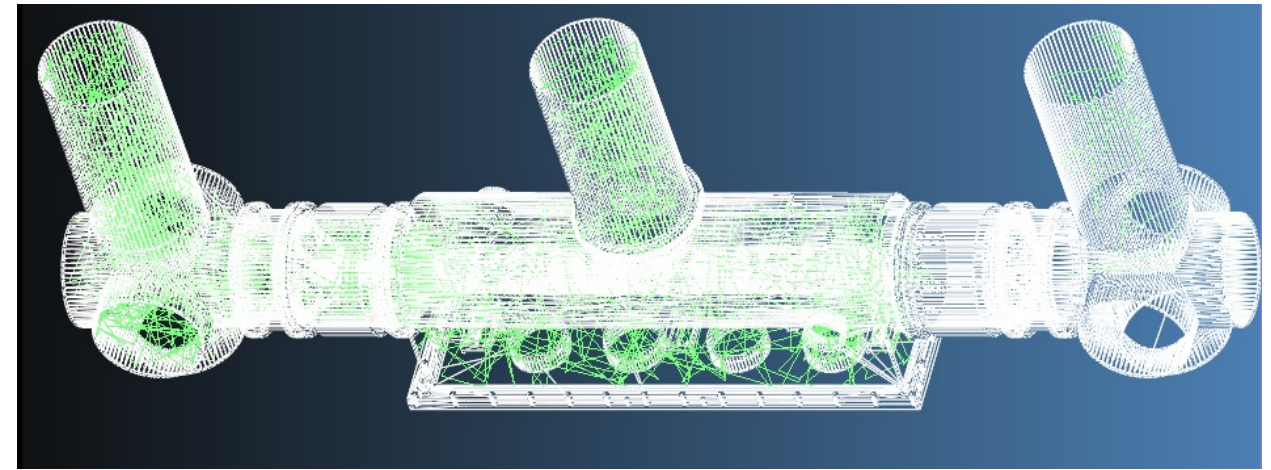

MolFlow+ test particles (**green**) within a complex geometry

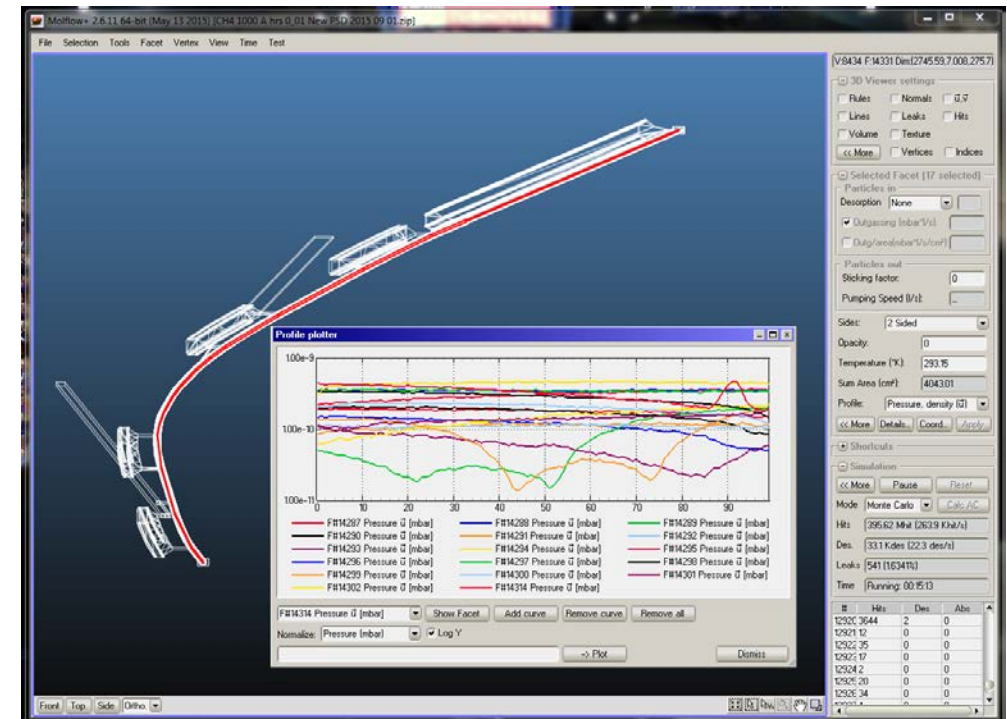

MolFlow+ for Windows user interface



# MolFlow+ for complex conductances

- MolFlow+ is a 3D TPMC program created at CERN
  - Freeware for Windows and Mac, no license required
    - <http://test-molflow.web.cern.ch/content/molflow-downloads>
- Vacuum pressure simulations within 3D models
- Models consist of connected planar surfaces called 'facets' representing interior surfaces of vacuum system
- Pumping and outgassing definitions applied to facets
- STL format import allows complex geometries to be designed in 3D CAD, imported into MolFlow+

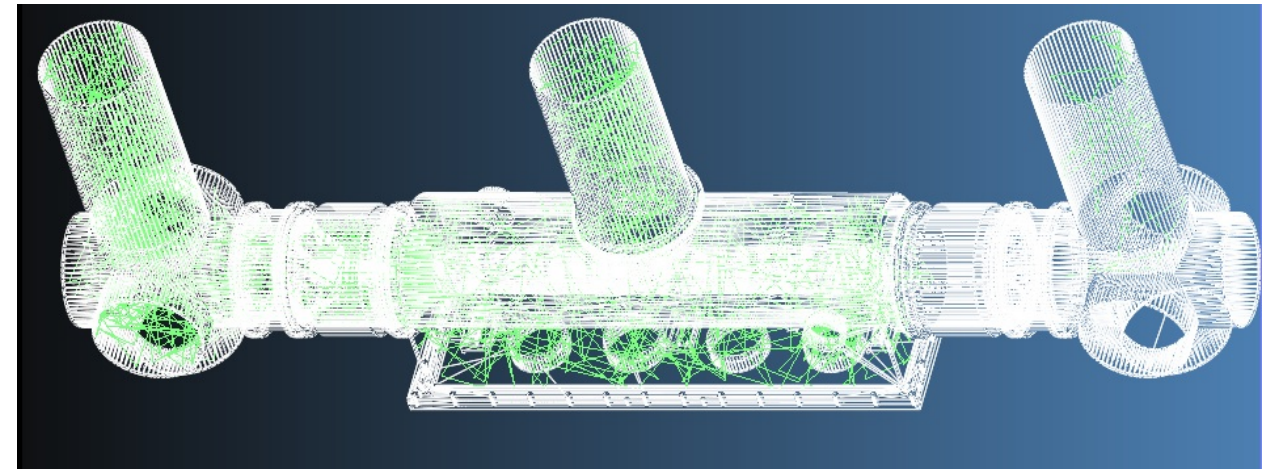

MolFlow+ test particles (**green**) within a complex geometry

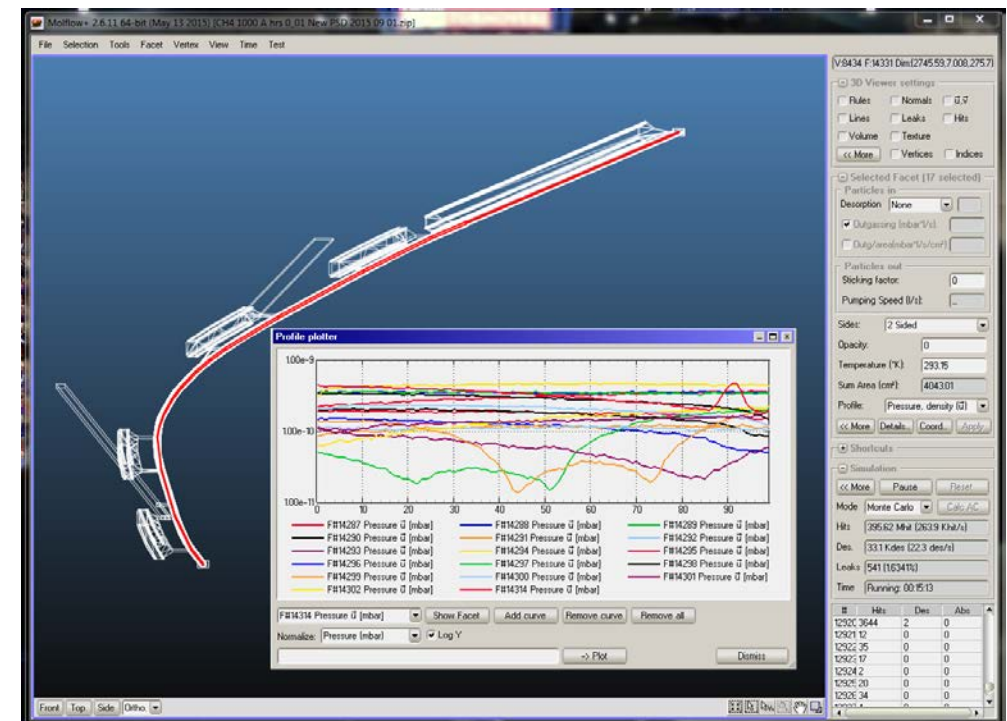

MolFlow+ for Windows user interface

# MolFlow+ pros and cons

- Pros
  - Free!
  - Rewarded for complex of 3D models in conductance calculations
  - Monte Carlo means large models computed on PCs in hours
- Cons
  - Learning curve requires 3D CAD knowledge, experience with program tools
  - Problems have to be debugged independently
- Competitors
  - VacCalc for 1D simulations
    - Complex conductances approximated or computed separately in MolFlow+
    - Can't investigate photon scattering effects
  - COMSOL UHV module for 3D simulations
    - Don't yet have synchrotron radiation module for coupled simulations

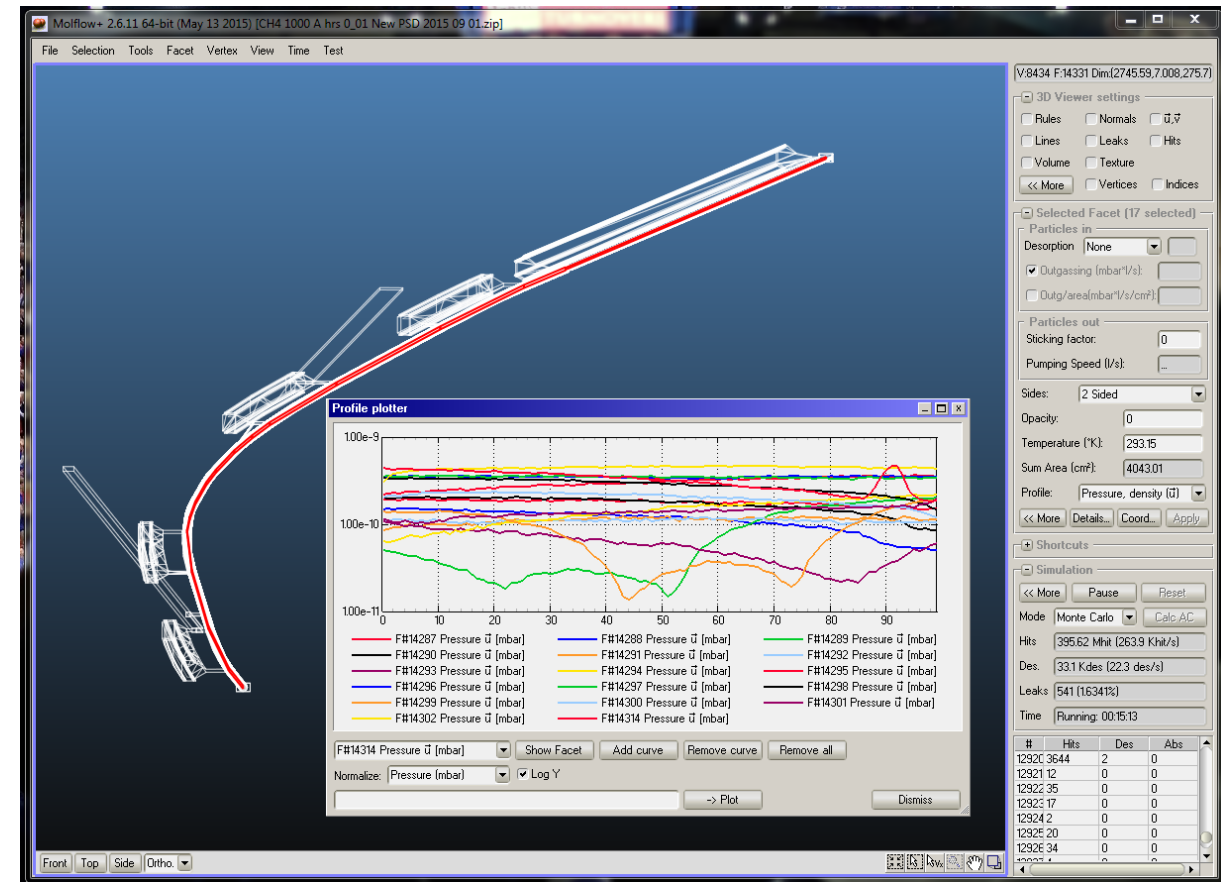

MolFlow+ for Windows user interface

# Predicting the gas load

- For a 1-D analysis, the PSD gas load is determined as a function of the photon distributions determined by a ray trace
  - Ray trace created with 2D CAD
  - Function determined by PSD measurements for vacuum surface
- Ray traces difficult to construct, manipulate for design
- No means for predicting photon scattering in 2D
- SynRad was created at CERN to perform 3D photon ray traces and assist with the gas load prediction...

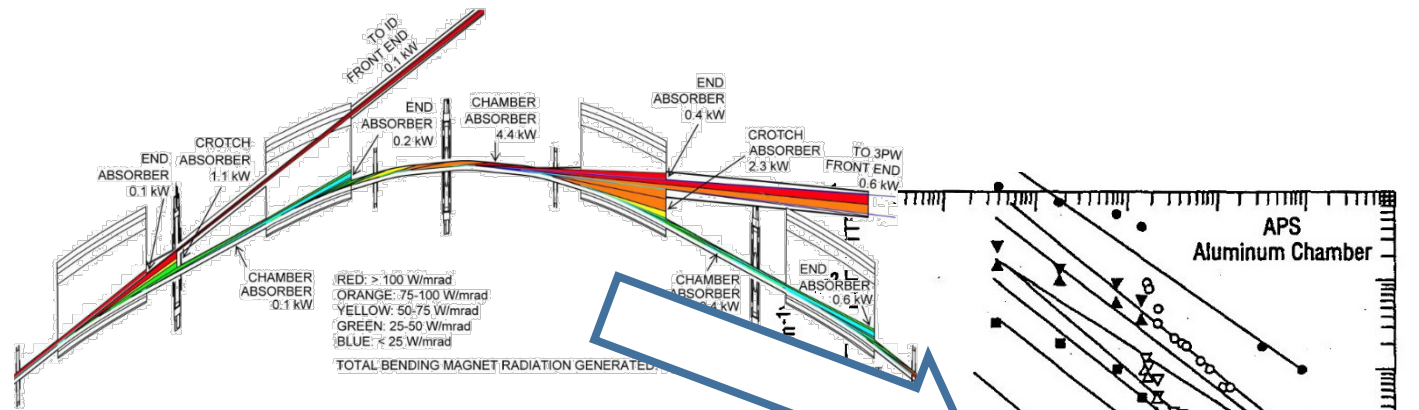
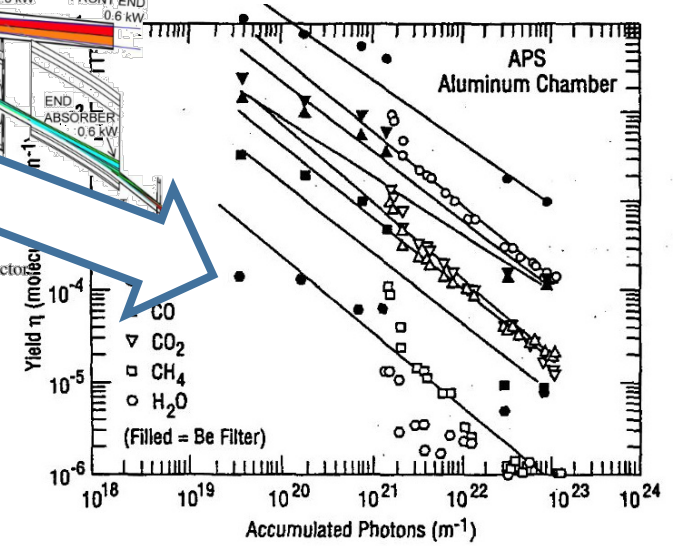
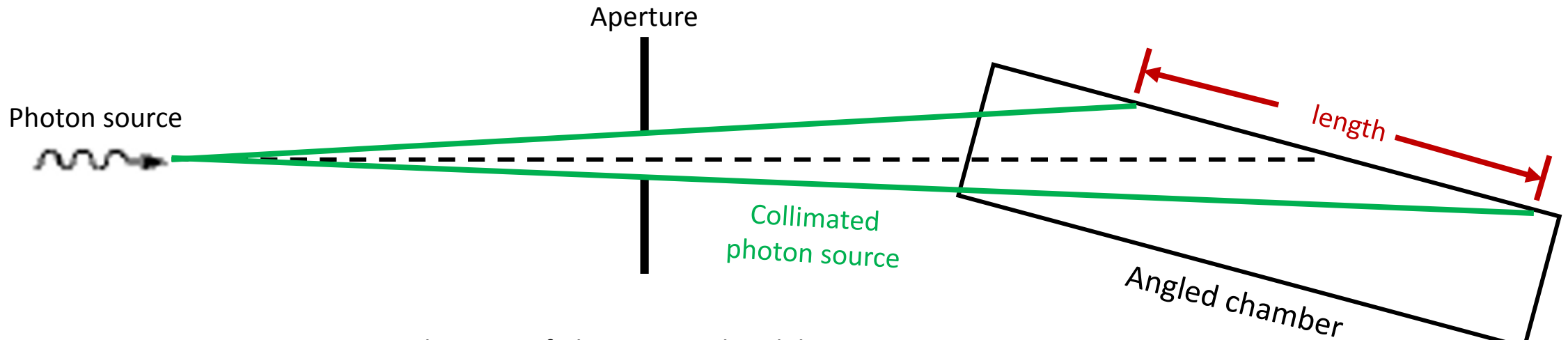

Figure 4: Distribution of bending magnet radiation for a typical storage ring sector

Example photon ray trace



Example PSD measurement



Schematic of photon stimulated desorption measurement

# SynRad

- SynRad – SYNchrotron RADiation
  - Freeware for Mac or PC, no license required
    - <http://test-molflow.web.cern.ch/content/synrad-downloads>
  - Uses Monte-Carlo methods to generate photon trajectories from magnetic sources within a 3D model
  - 3D geometry consists of connected facets and can be shared with MolFlow+
  - Can compute photon flux and power quantities, densities, and spectrums

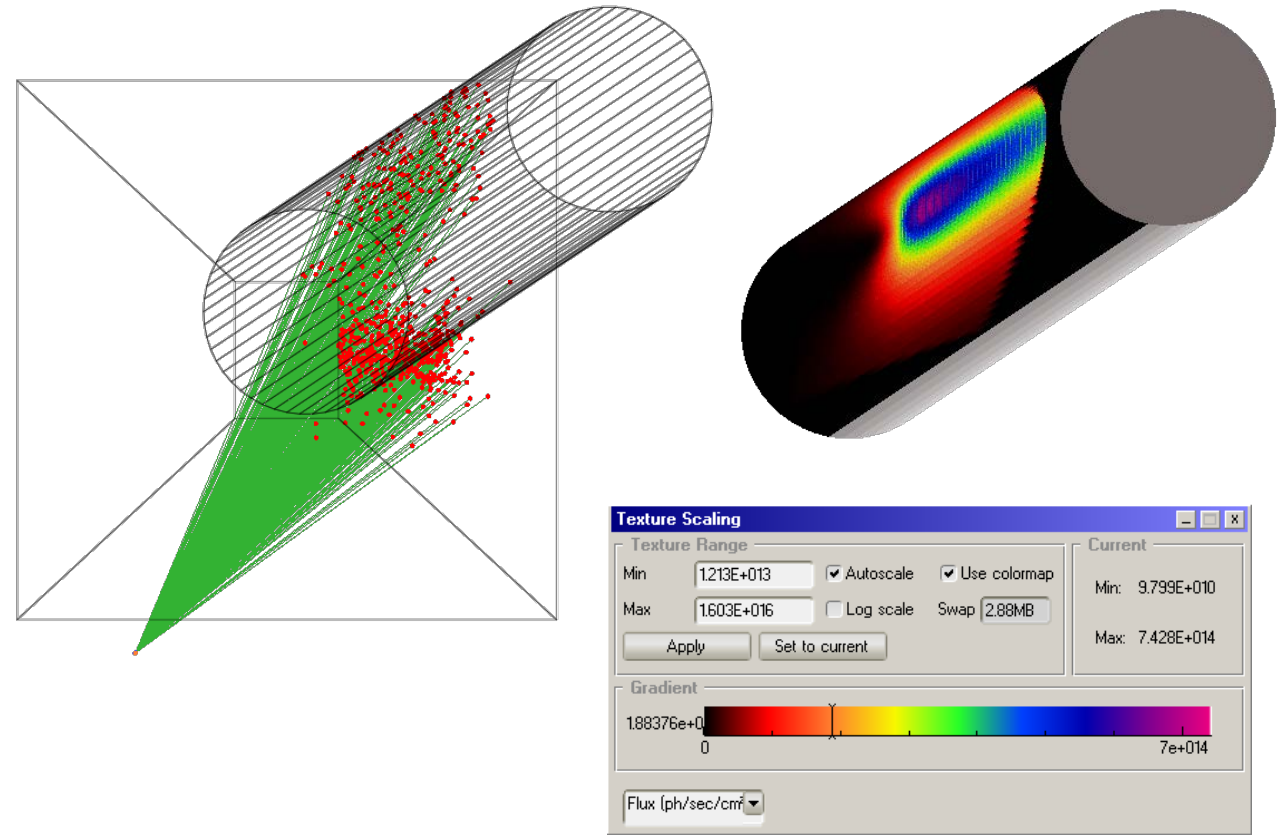

(left) SynRad Monte-Carlo photon paths (**green**) and landing points (**red**) from a dipole source, passing through an aperture to the walls of a tube  
(right) flux density distribution on walls of tube

# SynRad, cont'd

- Magnetic source options include dipoles, quadrupoles, wigglers, custom sources
  - Multiple sources within a full sector can be imported with manipulation of a typical 'lattice file' spreadsheet
  - Ray traces verified with high accuracy to 2D ray trace
- Reflection and roughness properties set on facets
- Photon distributions can be modeled with or w/o photon scattering
  - 'No scattering' equivalent to 2D ray trace with vertical beam height

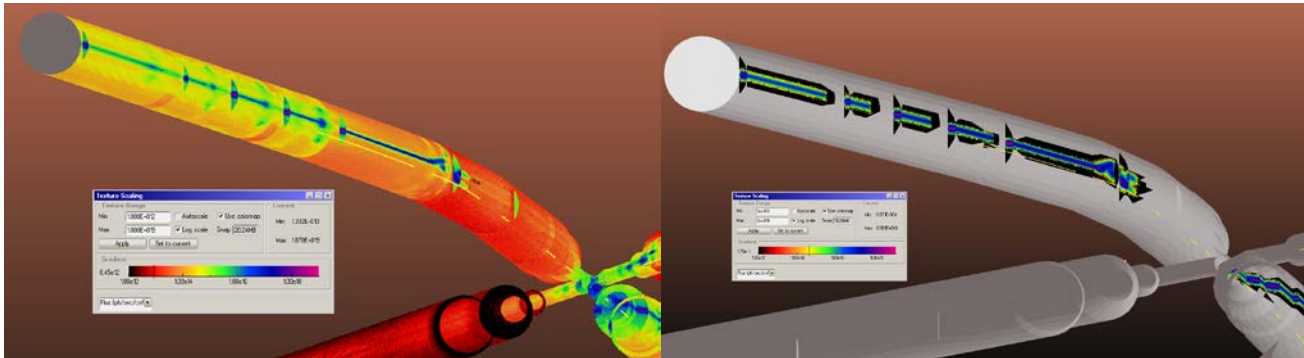

SynRad flux densities in equal log scale with scattering (left) and without (right)

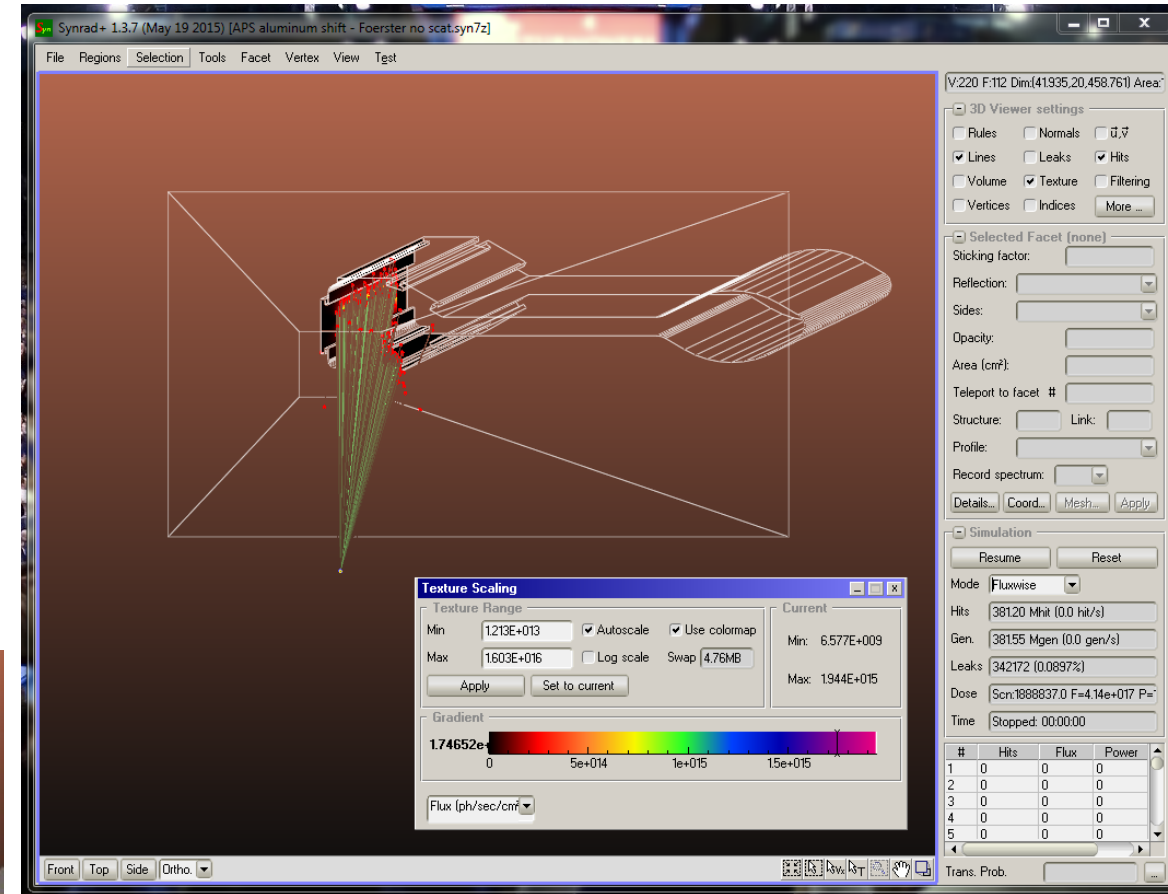

SynRad for Windows user interface

# SynRad photon distributions

- Photon distribution can be modeled with or w/o photon scattering
- Scattering determined in 2 step process
  - 1) Material reflection table referenced to determine probability of scattering based on angle and photon energy
    - Trends: low energy photons scatter more, shallow incidence photons scatter more
  - 2) Surface roughness accounted for by perturbing reflection angle with Gaussian distribution offset which incorporates a roughness ratio
    - Roughness ratio =  $\text{RMS roughness} / \text{correlation length}$
    - Higher ratio scatters more diffusely

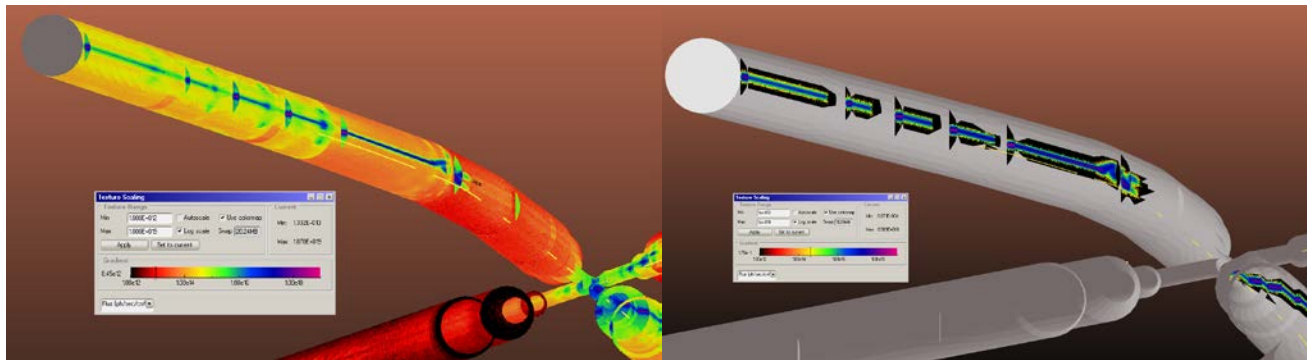

SynRad flux densities in equal log scale with scattering (left) and without (right)

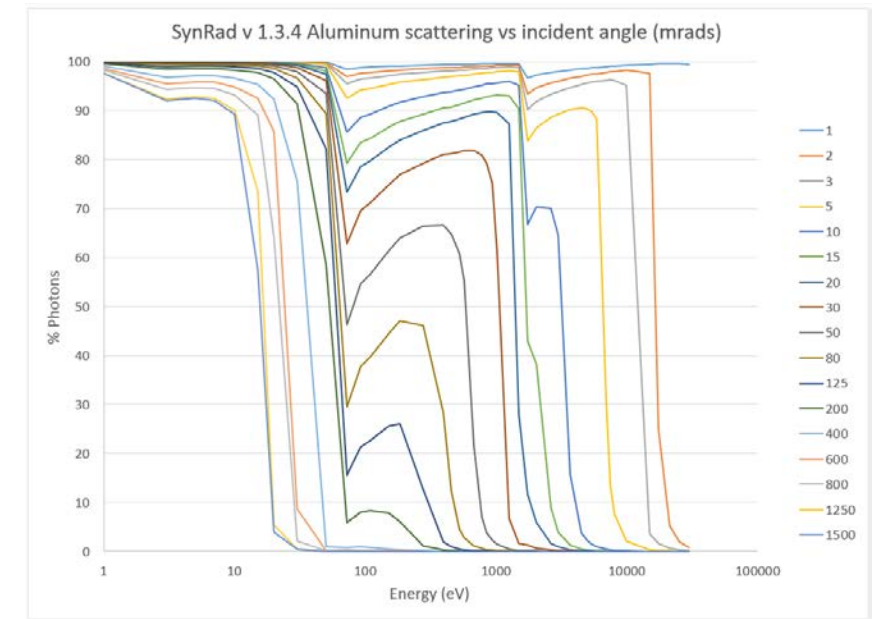

(1) Material reflection table for Aluminum

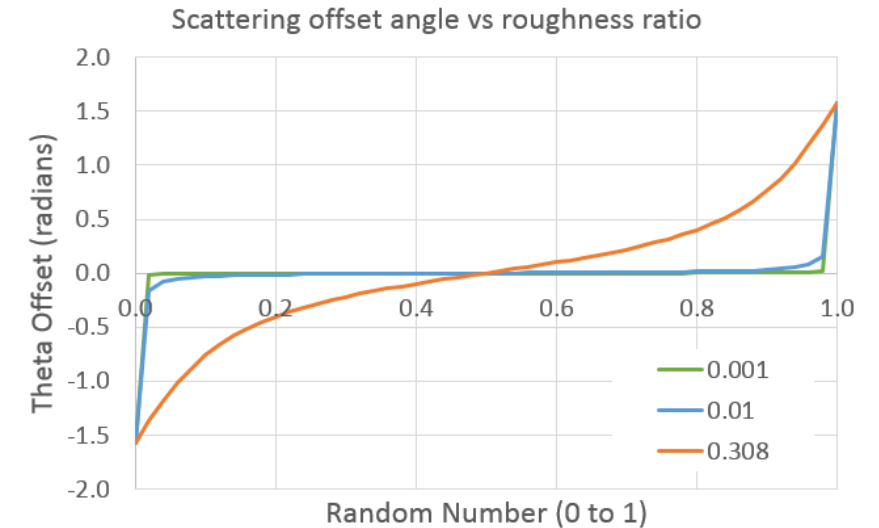

(2) Offset angle determined based on roughness ratio

# SynRad pros and cons

- Pros
  - Free!
  - Rewarded for complex 3D models with accurate ray traces
  - Monte Carlo means large models computed on PCs in hours
  - Photon heat loads can be imported into ANSYS as complex thermal loads
- Cons
  - Learning curve requires 3D CAD knowledge, experience with program tools
  - Problems have to be debugged independently
  - Scattering algorithms may be adequate for vacuum predictions, not fully benchmarked for physics analysis
- Competitors
  - SynRad3D (Cornell) for photon distributions with scattering
    - Benchmarked for photon scattering
    - No 3D interface and large file sizes
    - No connection to a vacuum software

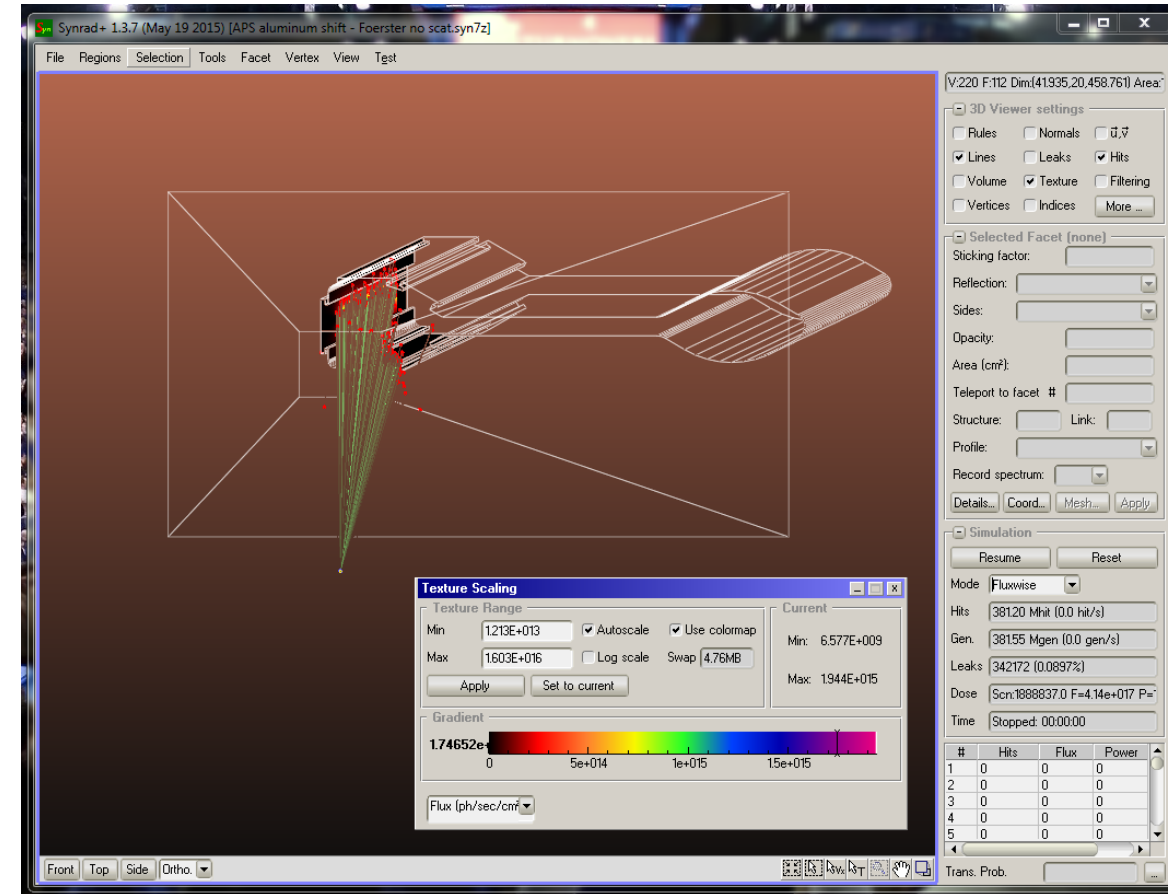

SynRad for Windows user interface

# SynRad/MolFlow+ coupled simulations

- SynRad/MolFlow+ 'coupled simulations' is a feature in which SynRad generated fluxes can be mapped as PSD outgassing in MolFlow+
  - The mapping requires experimental PSD measurement data
- Conditioning time is incorporated into the process
  - User chooses time point, where increased time leads to increased accumulation and thus lower outgassing due to cleanup
- Tool for predicting evolution of gas load and thus pressures

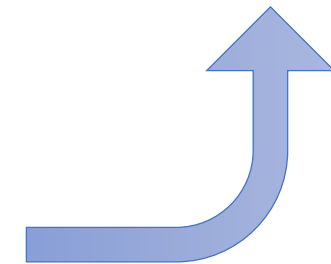
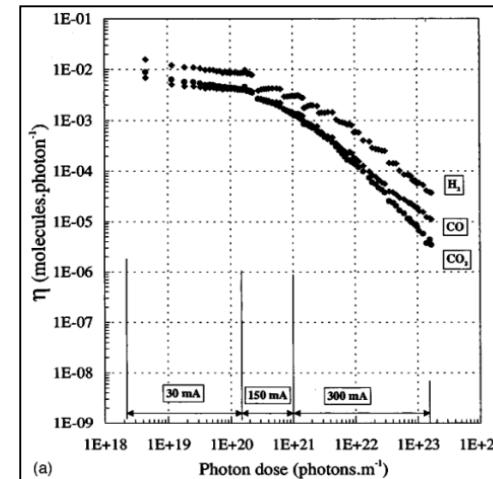
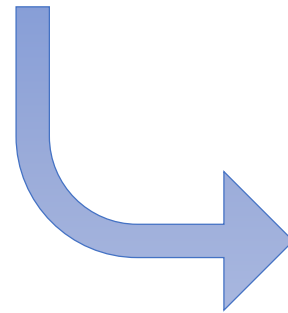
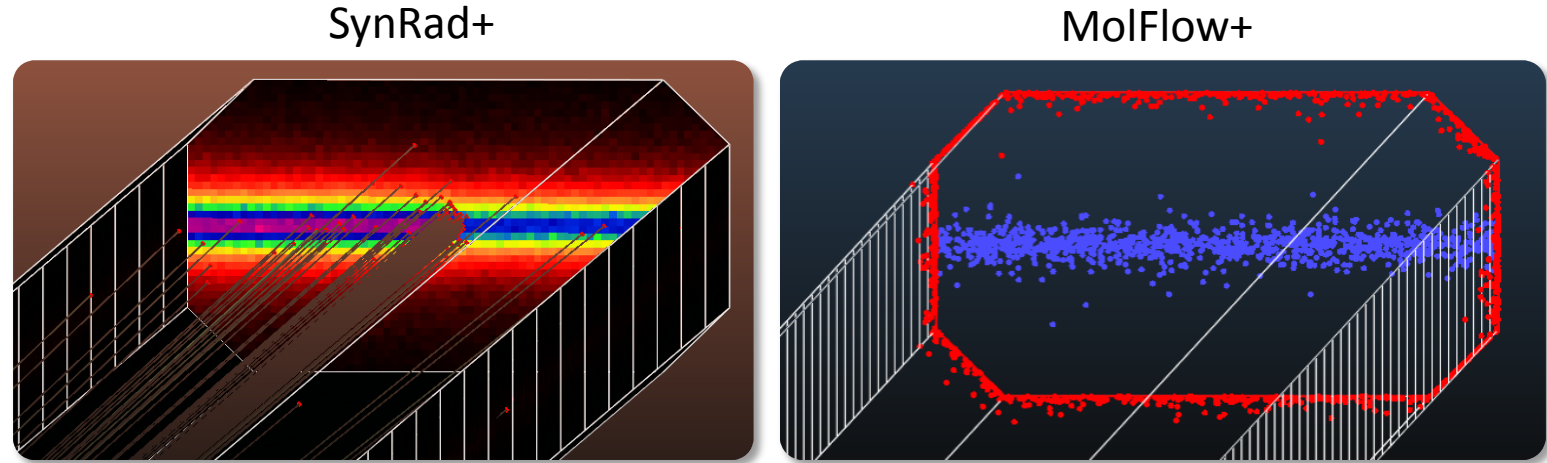



# SynRad/MolFlow+ coupled simulations

- PSD yield measurements published by C.L. Foerster and more for variety of vacuum metals and surface treatments
- Flux distribution from experiment recreated in SynRad
- A 'flux to outgassing' map is tuned until measurements are matched when converted into MolFlow+
  - Tuning requires a determine a conversion factor unique to each experiment linking SynRad **area** photon densities (pho/cm2) to experimental **linear** photon densities (pho/m)
- Goal to perform PSD yield measurements for our own chamber designs, increase confidence in both 1D and 3D simulations

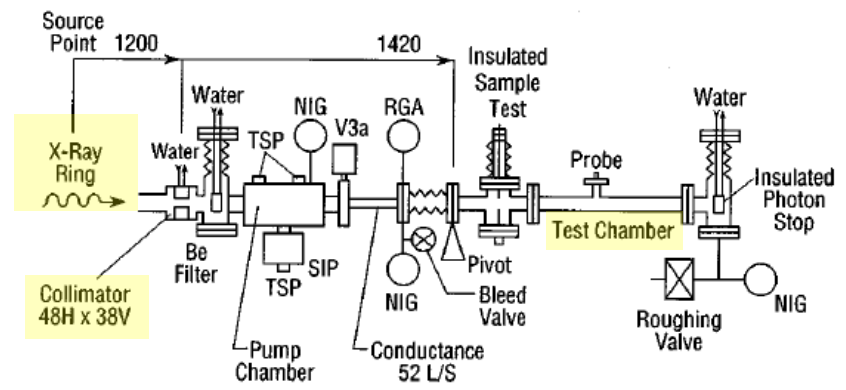
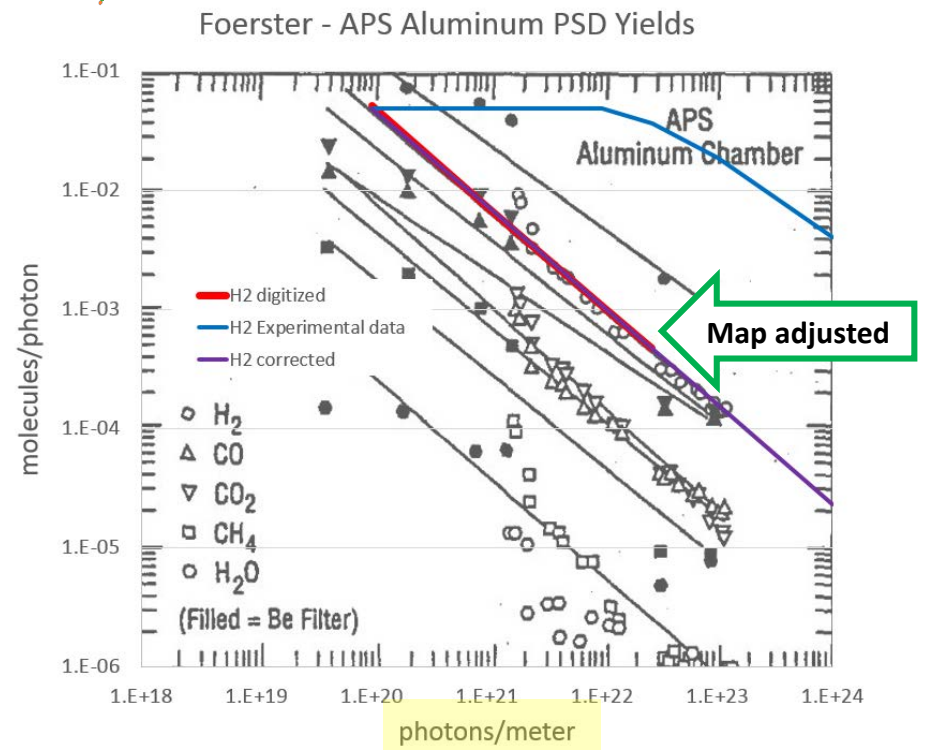
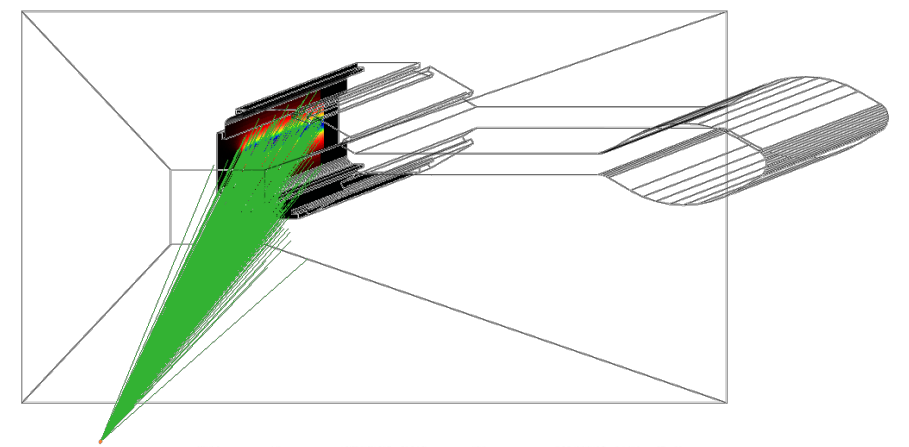

FIG. 1. Schematic diagram of experiment of NLSL X28A Beamline setup. SIP: sputter ion pump; TSP: titanium sublimation pump; NIG: nude ion gauge; and RGA: residual gas analyzer. Source points are in cm.

Schematic of typical PSD measurement:  
Photon source, collimator, and angled chamber



Digitized yields used as initial map, then 'corrected' in MolFlow+ until yields match experiment

# SynRad/MolFlow+ review

- Vacuum system analysis
  - Calculate pressures to evaluate vacuum system design
- MolFlow+
  - 3D vacuum pressure simulations
  - Complex chamber conductances accounted for with test particle method process
- SynRad
  - 3D synchrotron radiation simulations
  - Flux and thermal distributions
  - Ray traces with and without photon scattering
- Coupled simulations
  - Predict dynamic PSD gas loads
  - Compute dynamic pressures based on mapping of PSD measurements
  - Predict conditioning time and beam lifetimes

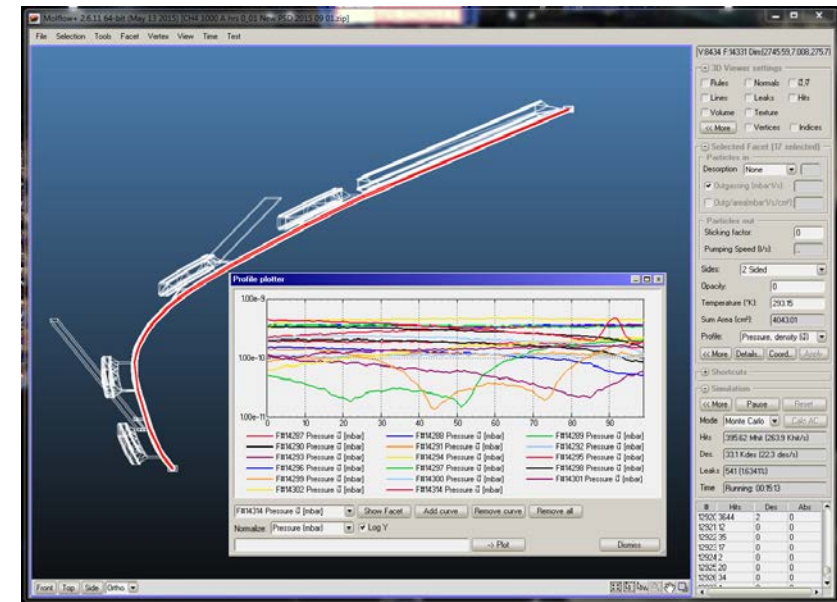

MolFlow+ for Windows user interface

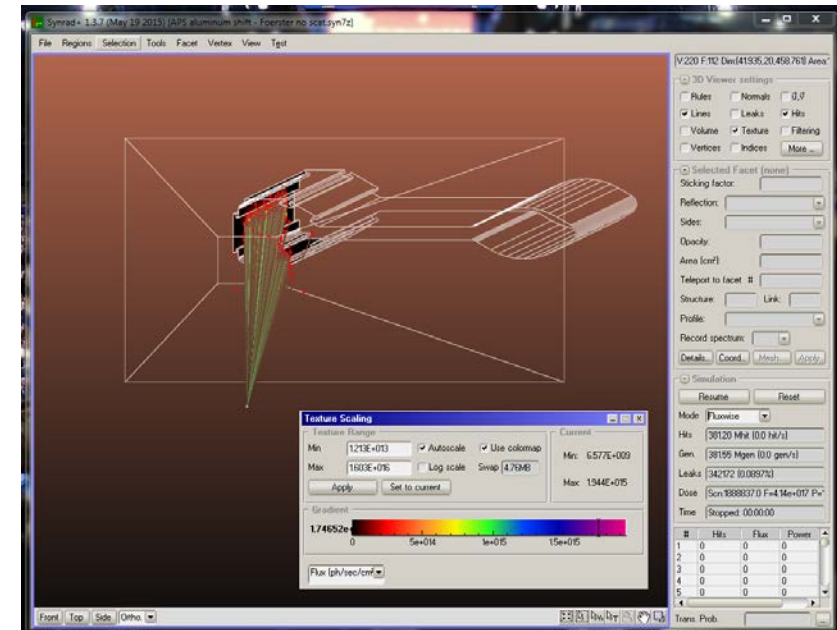

SynRad for Windows user interface

# SuperKEKB overview

- KEKB is the world's highest luminosity machine. Shutdown in 2010 for SuperKEKB upgrade
- Commissioning this year with goals for 40x higher luminosity
- Belle-II detector collects data from electron positron collisions

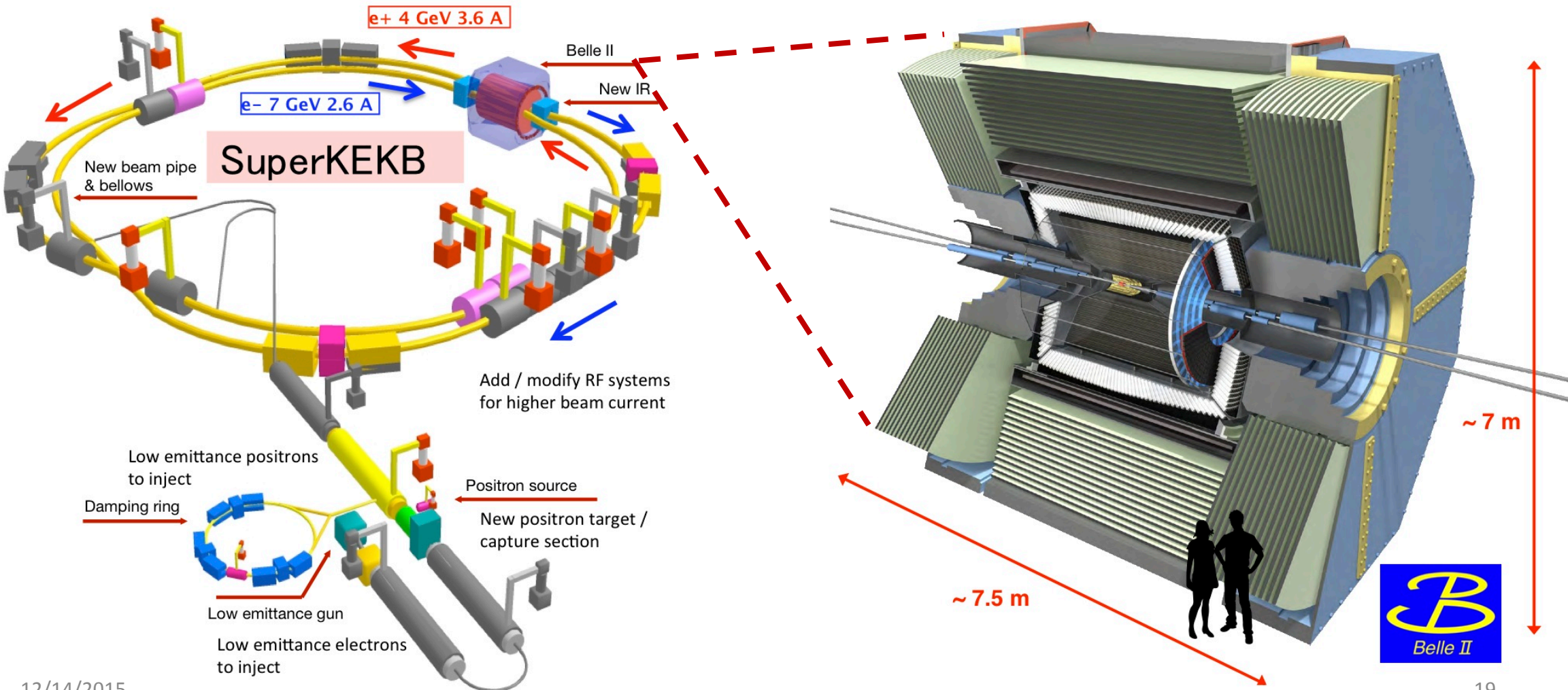

# Project goals

- SuperKEKB vacuum system target pressure of 6E-7 mbar near interaction point
- Goal: Predict conditioning time to reach desired pressure at interaction point

The pressure around the IP is estimated for sections A, B, and C of the beam duct. The main gas load is due to photon-desorption by synchrotron radiation. The pressure around the IP is determined mainly by this part of the beam duct. An approximate estimate of the pressure can

63

CHAPTER 3. IR DESIGN

be made by considering a model pipe where both ends, one at IP and the other at the pump port, are closed. The pressure at the pump is determined by the total gas load in the pipe and the pumping speed. The pressure difference between the IP and the pump is determined by the gas load and the conductance of each segment and is independent of the pressure at the pump. Assuming a sufficiently scrubbed value of the photo-desorption coefficient of  $10^{-5}$ , the pressure at the IP and at the pump is estimated as  $6 \times 10^{-5}$  and  $6 \times 10^{-6}$  Pa, respectively, for the design current. Though the pressure is acceptable from the view point of the detector background according to recent studies at KEKB, the pressure is high enough to affect the average pressure in the ring. A sketch of the left hand side vacuum system is shown in Fig. 3.9. The design is similar to the right hand side (see Fig. 3.6). However, in this case, the space between the cryostat and the QC2LP magnet is very tight. Further iteration is necessary to design this part.

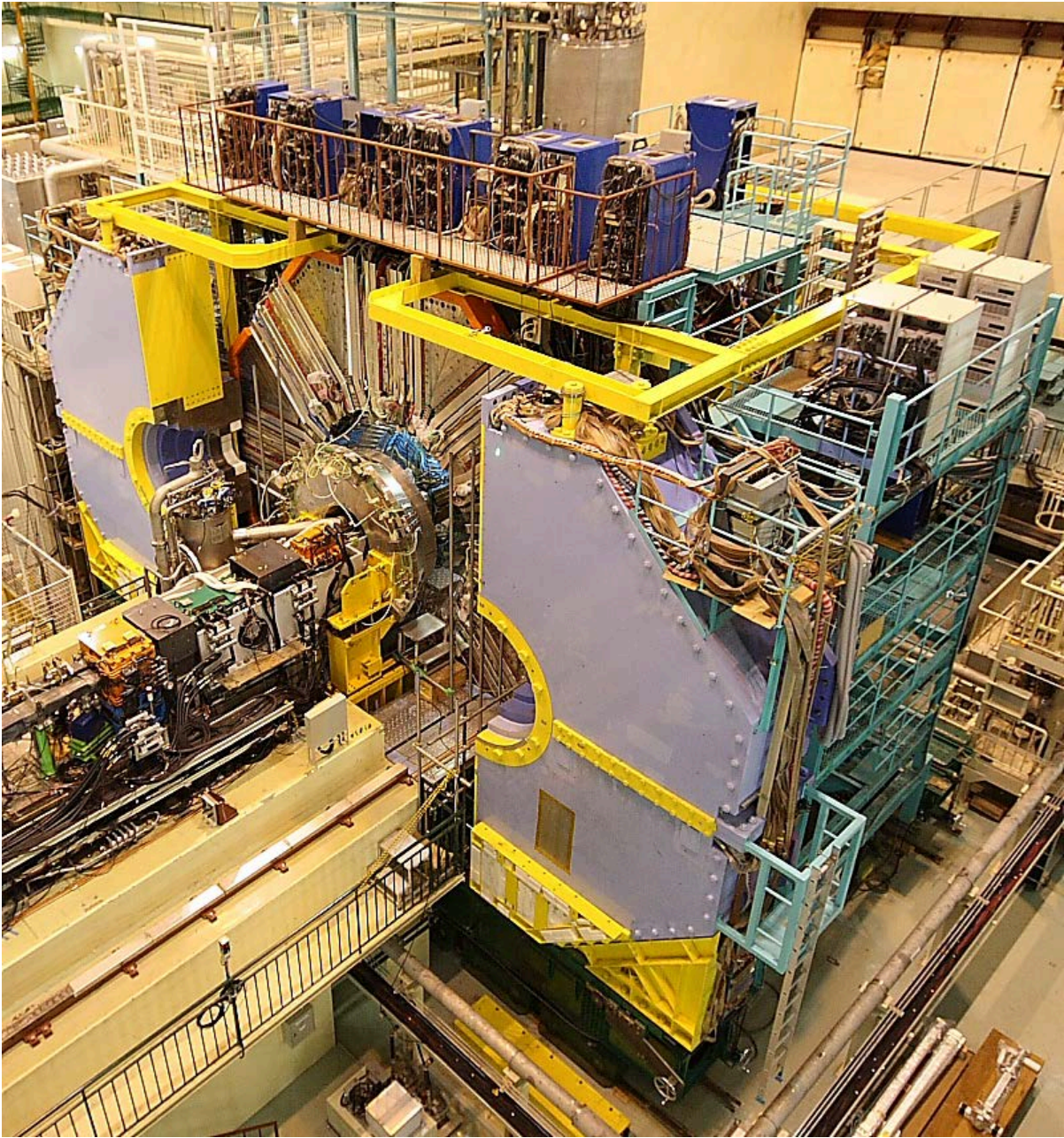
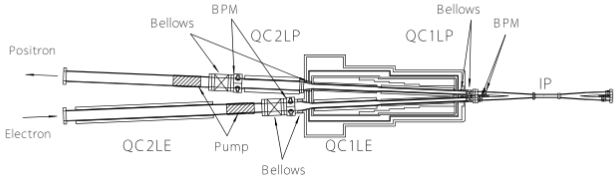

# SynRad/MolFlow+ goals

- SynRad/MolFlow+ coupled analysis for predicting photon stimulated gas loads and vacuum system pressures
- SynRad for predicting gas load
  - Build 3D model which can accurately capture photon fan ray trace, capture conductances in MolFlow+
  - Generate ray trace from photon producing magnetic elements
  - Translate photon load into photon-stimulated desorption (PSD) outgassing
- MolFlow+ for UHV pressures
  - Estimate effective pumping speed of simplified pumping elements
  - Calculate UHV pressures along beam path
  - Determine conditioning time to achieve targeted pressures based on evolving gas load

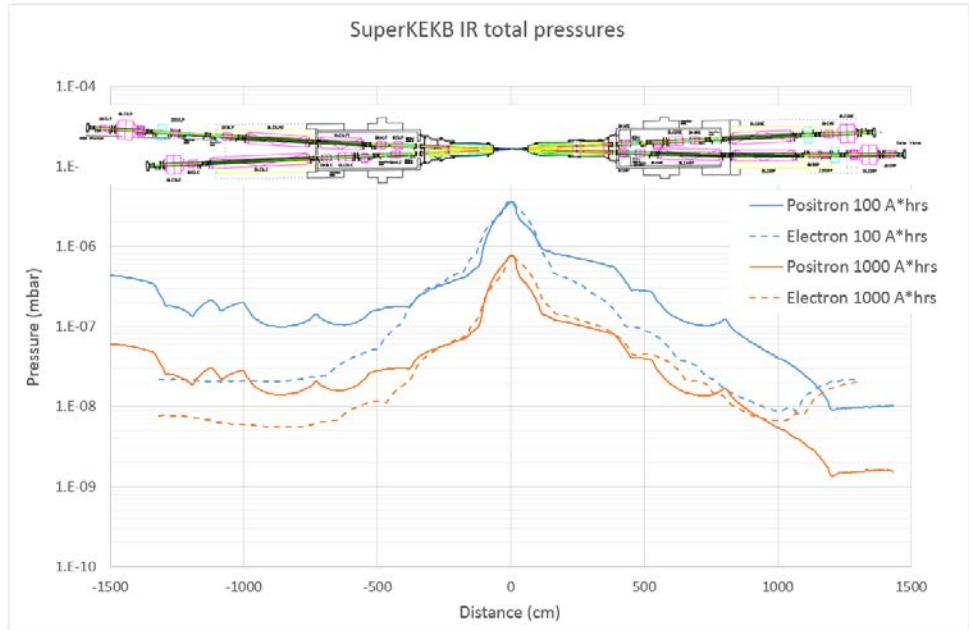
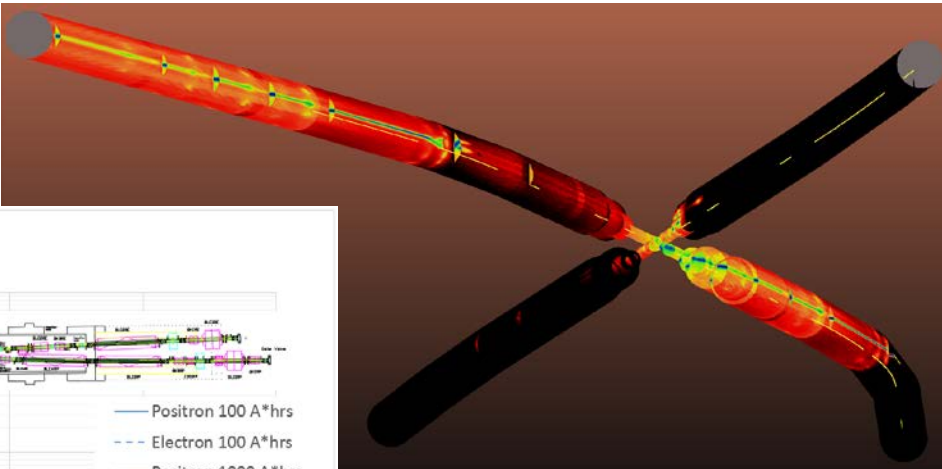
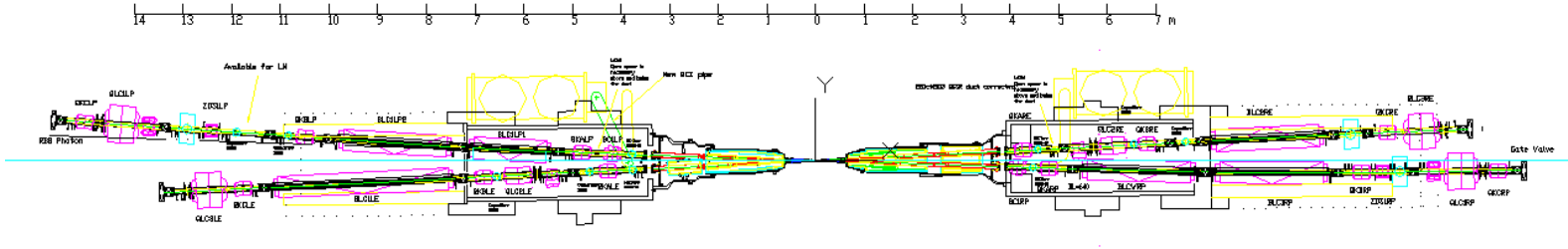

Coupled SynRad/MolFlow+ analysis: vacuum system CAD to SynRad model to MolFlow pressures

# Building a 3D model

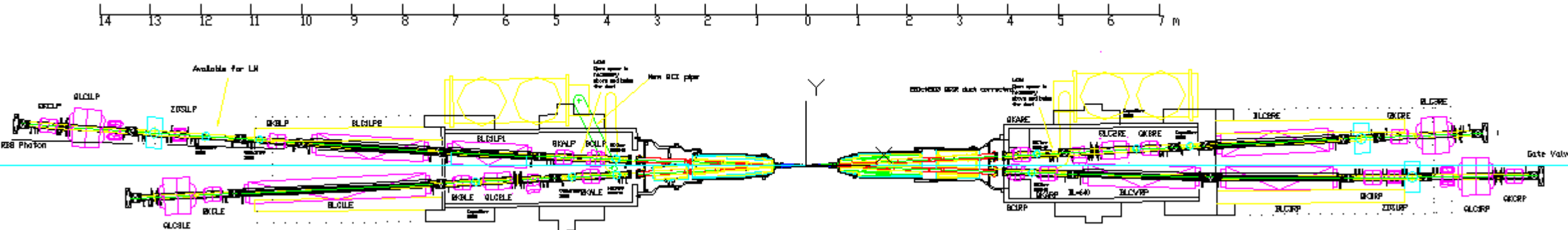

**AutoCAD overview**

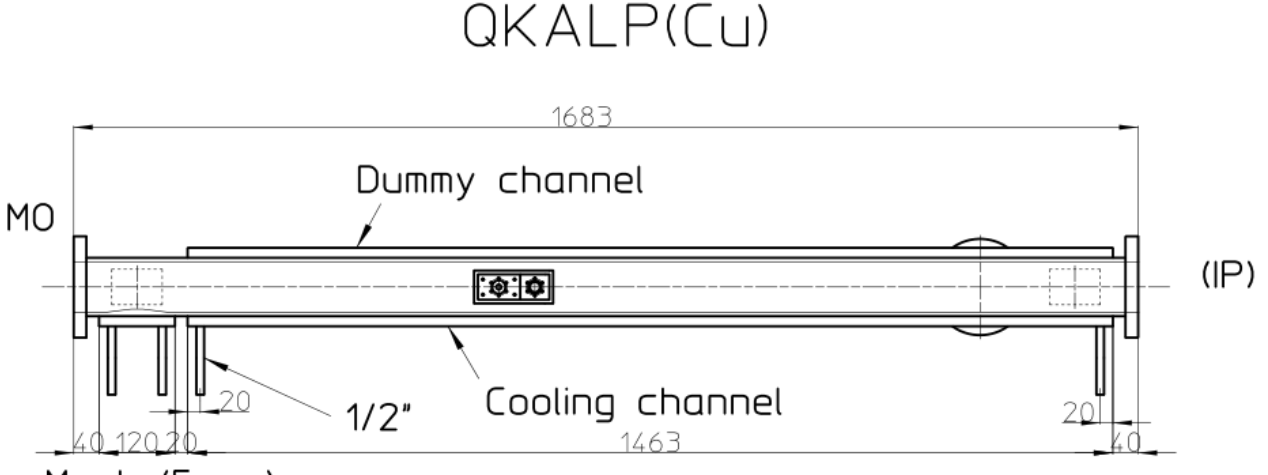
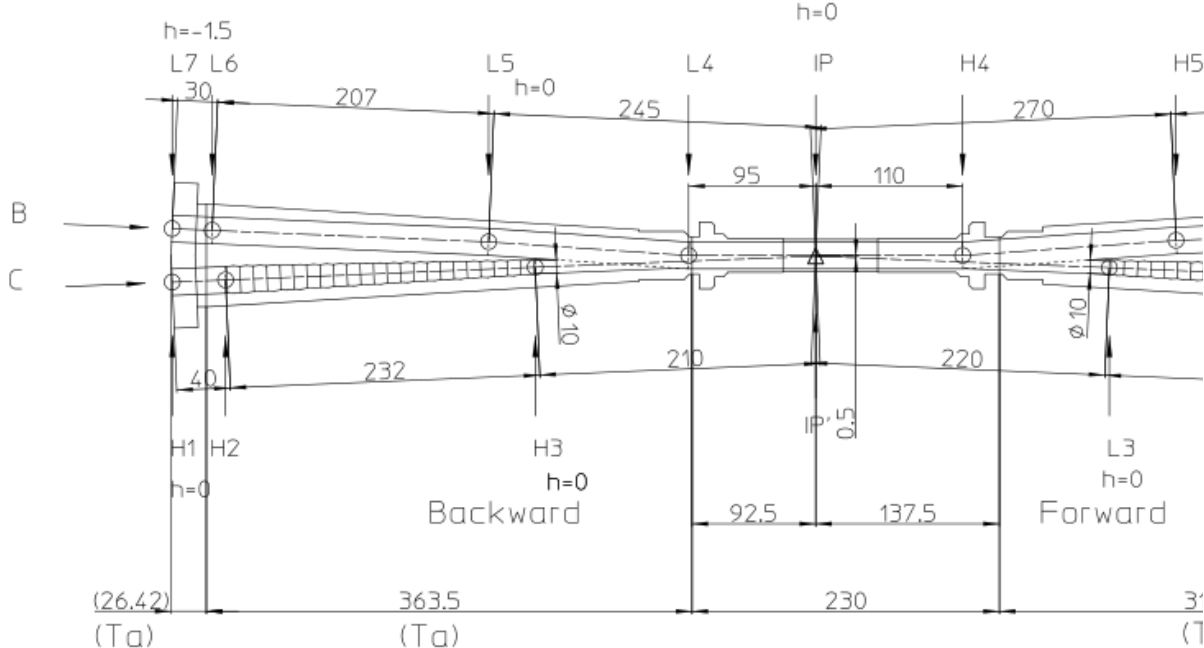

**Details individually**

# Building a 3D model

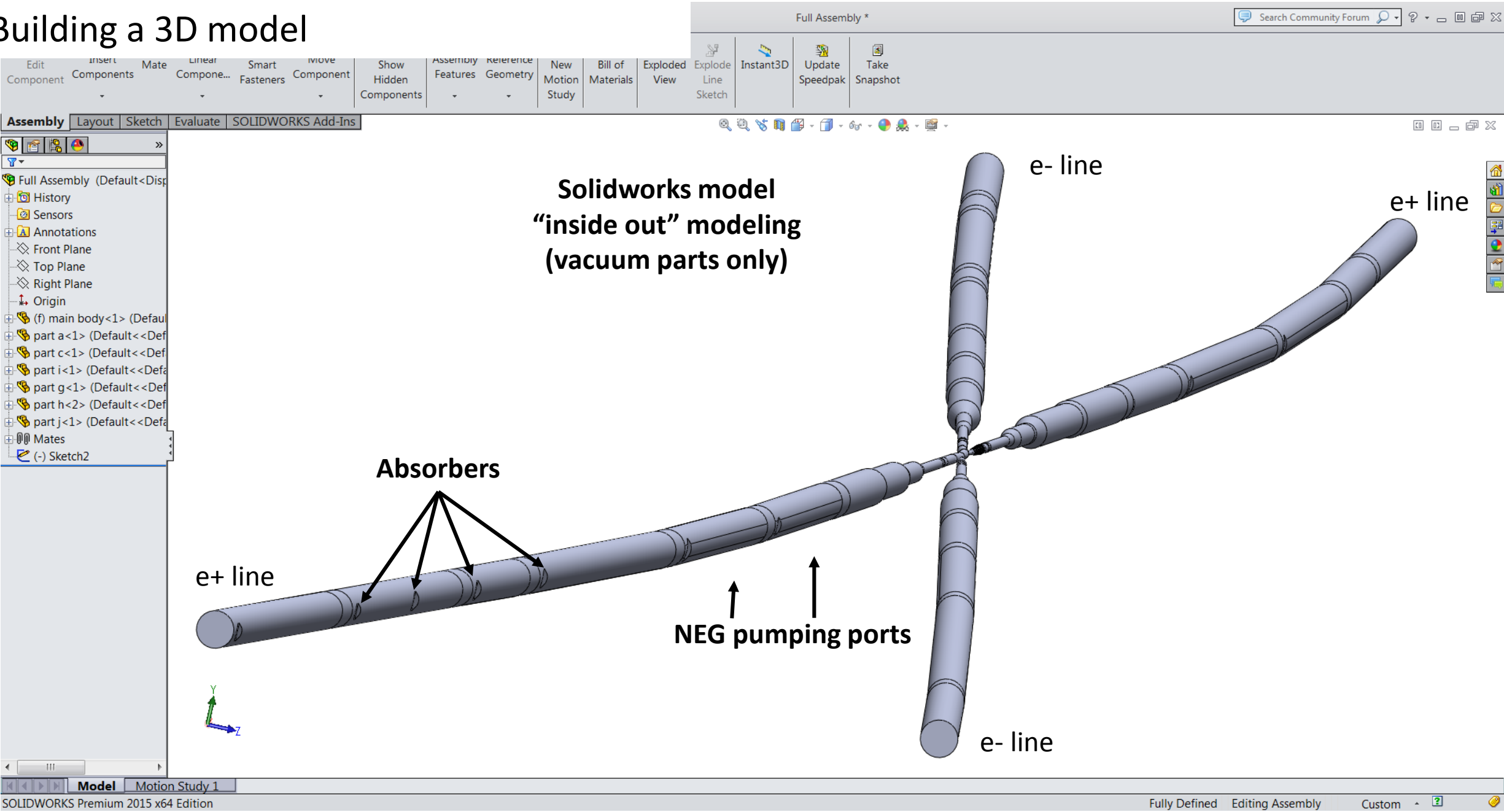

**Solidworks model  
"inside out" modeling  
(vacuum parts only)**

**Absorbers**

e- line

e+ line

e+ line

**NEG pumping ports**

e- line





# Benefits of surface 'splits'

- Surface 'splits' have added benefit of biasing random STL generation, preserving desired geometry
- Groups of surfaces identified for bulk properties such as pumping speeds or material definitions
- Beam receiving surfaces identified for hybrid meshing

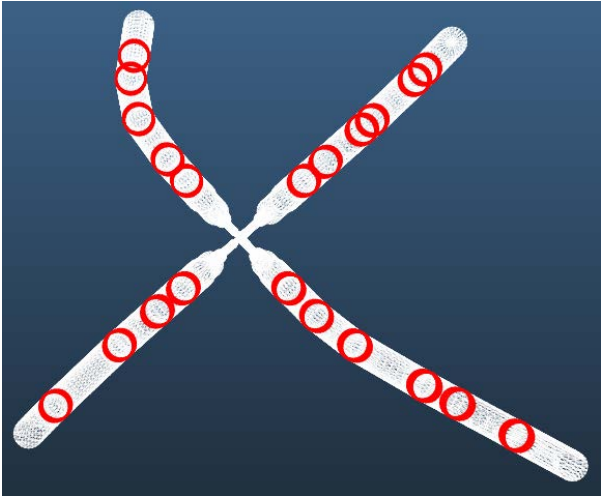
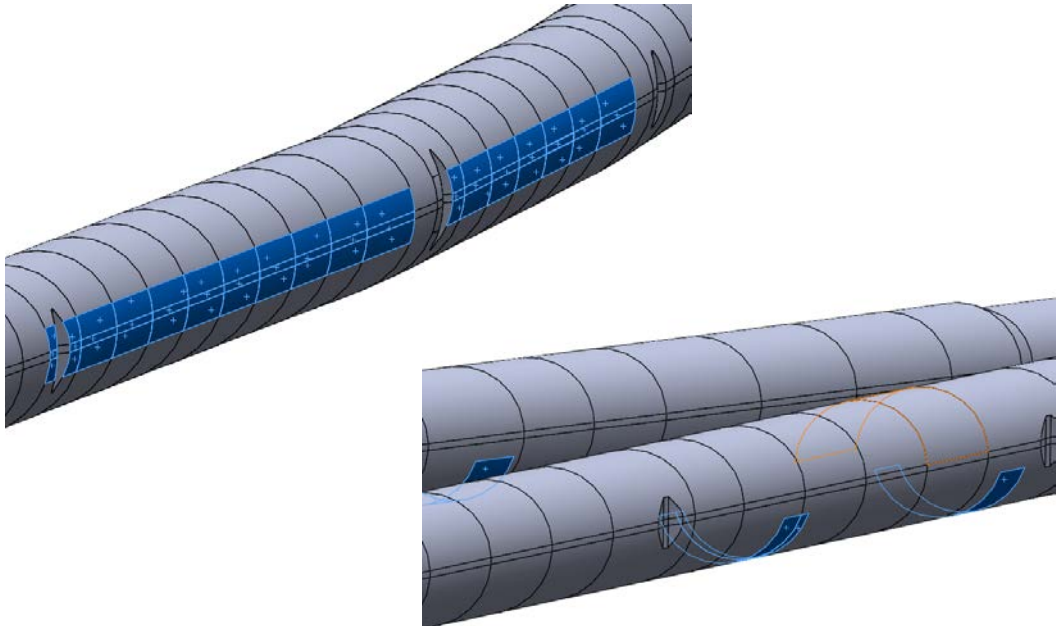

Bellows

Simplified antechamber and pumping port surfaces identified

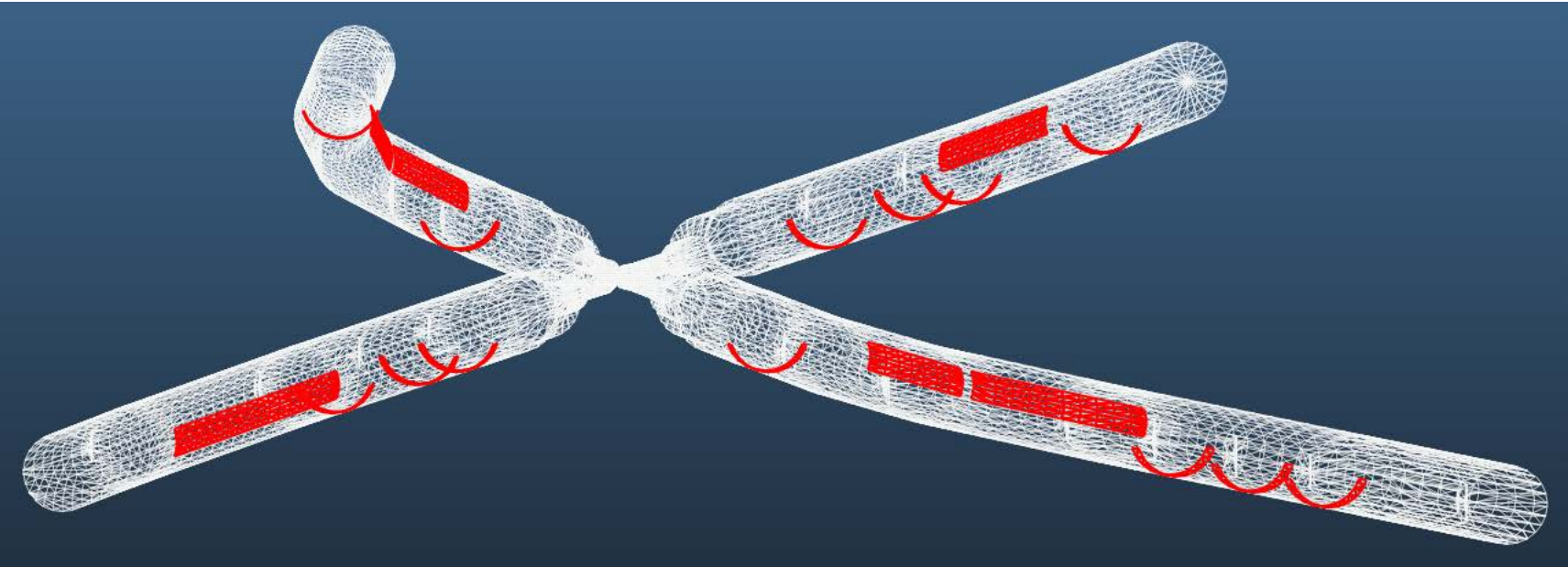

Pumping surfaces including ion pump ports and NEG strip antechambers

# Modelling the pumping system in MolFlow+

- Pumping from 4 types of elements:
  - NEG strips in antechambers
  - CapaciTorr D1000
  - NEX Torr D1000-10
  - 400 L/s ion pump
- Interaction region represents >10 meter length with no pumping
  - Reasonable to expect pressures peak here
- Need to simplify complexity of certain pumping chambers...

# Vacuum system of IR

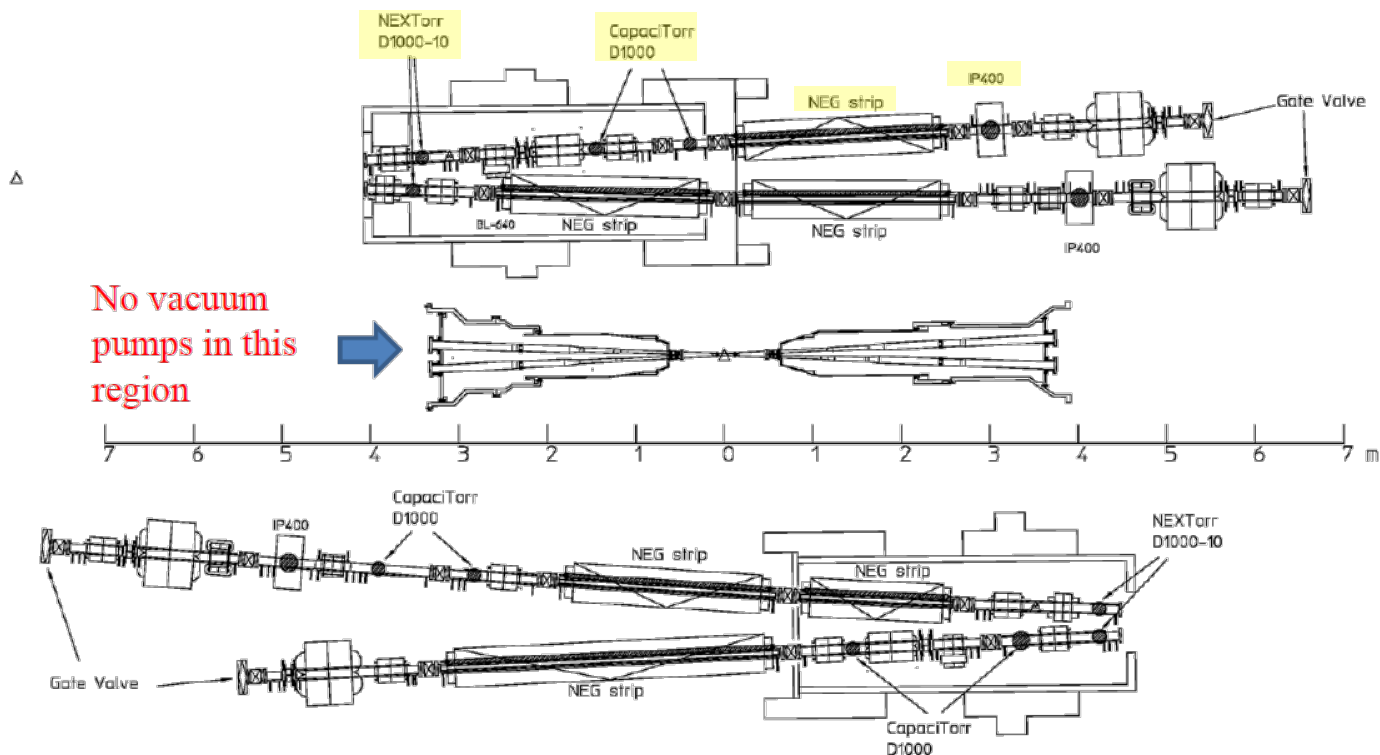

Locations of distributed and isolated pumping elements in red

# Simplifying the pumping system for MolFlow+

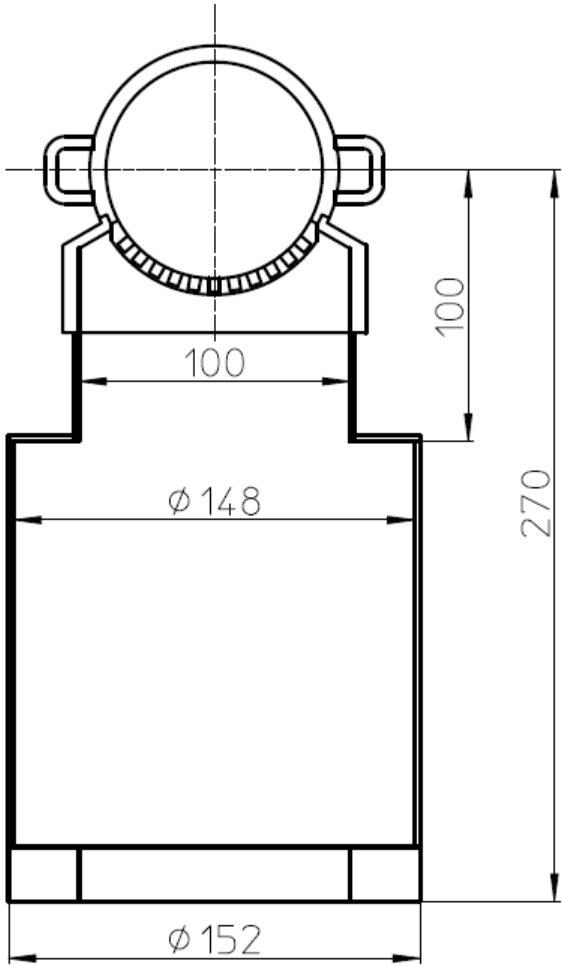

Example pumping port details

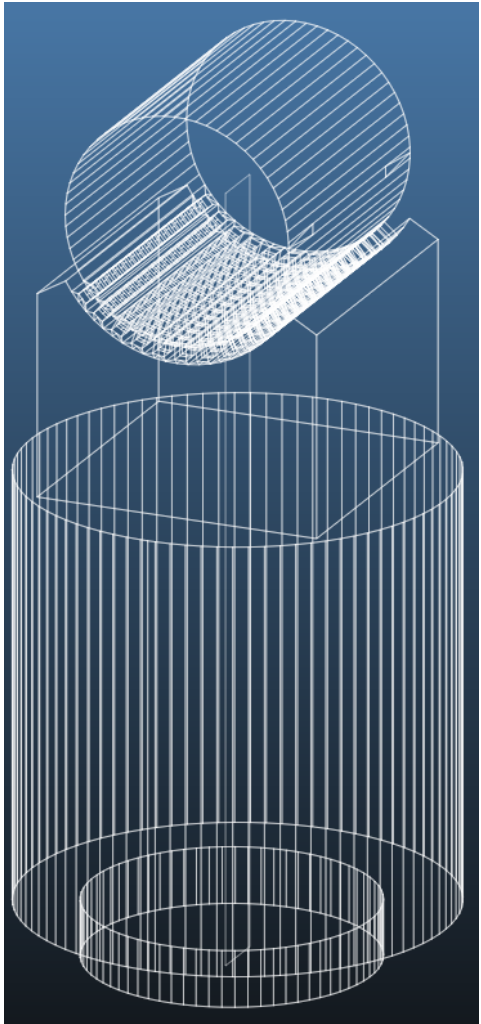

Representative MolFlow+ model of 'Type B' pumping port

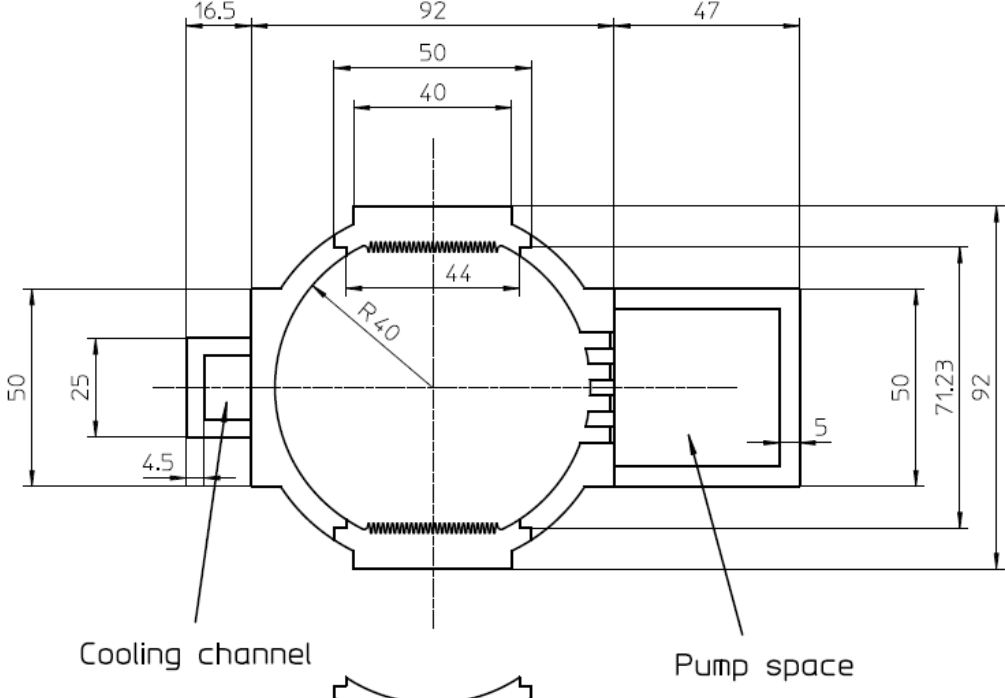

Antechamber details

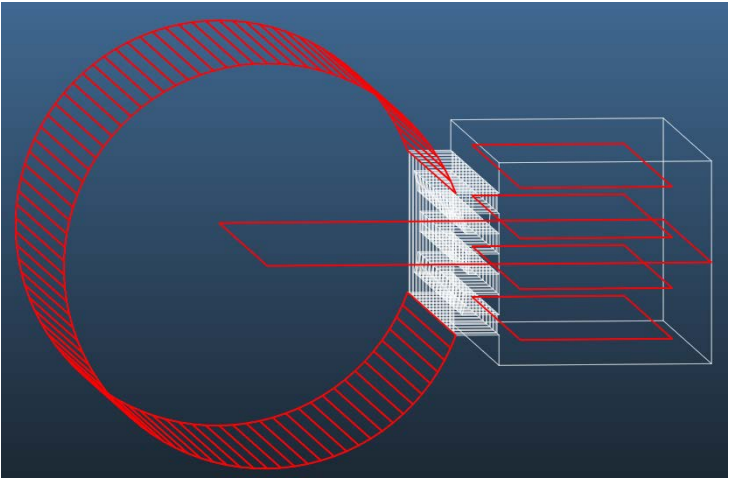

MolFlow+ model of bending magnet chamber with antechamber

# Modelling the pumping system in MolFlow+

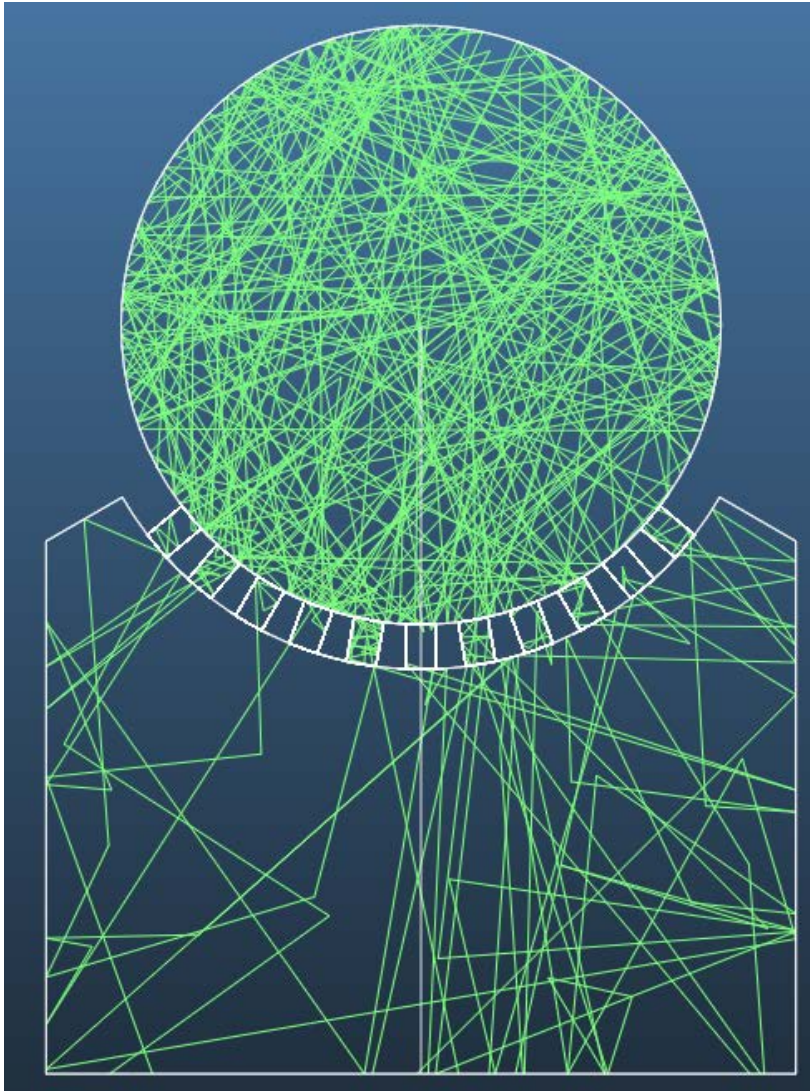

'Type A' pump port model

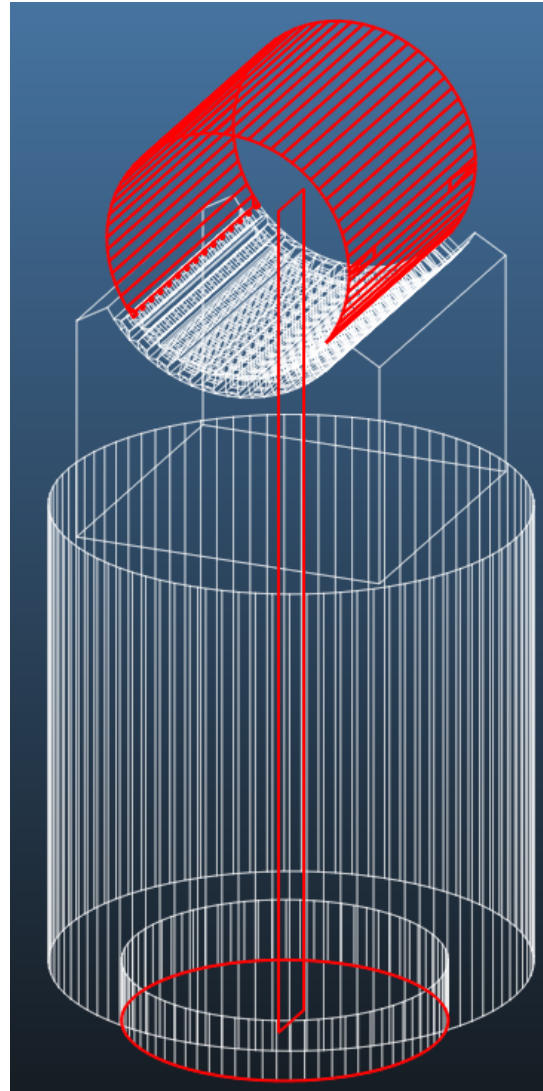

'Type B' pump port model

Gas	NEXTorr / CapaciTorr (L/s)	A $S_{\text{eff}}$ (L/S)	B $S_{\text{eff}}$ (L/S)
H <sub>2</sub>	1000	<b>400</b>	<b>370</b>
CO	500	<b>128</b>	<b>119</b>
CO <sub>2</sub>	500	<b>110</b>	<b>98</b>
CH <sub>4</sub>	20	<b>19</b>	<b>18</b>

NEXTorr effective pumping speeds

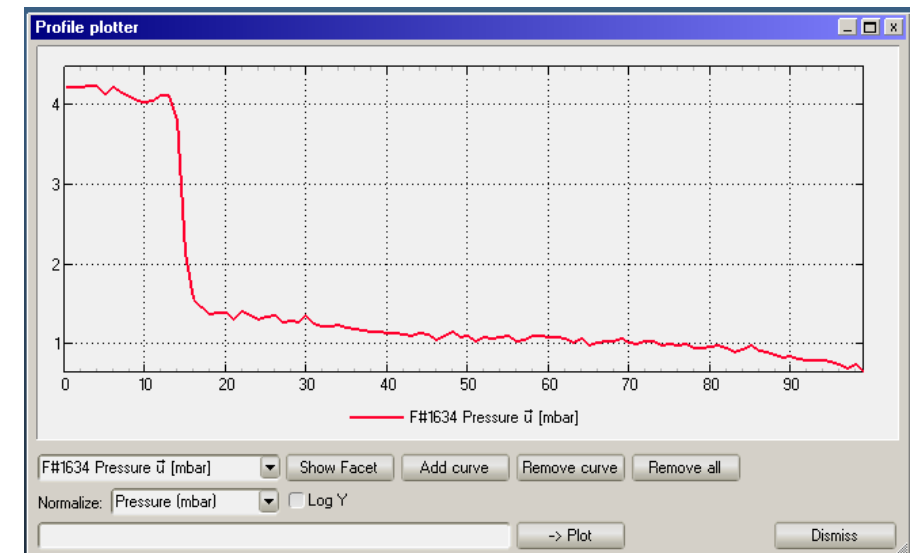

CO pumping reduction

# Modelling the pumping system in MolFlow+

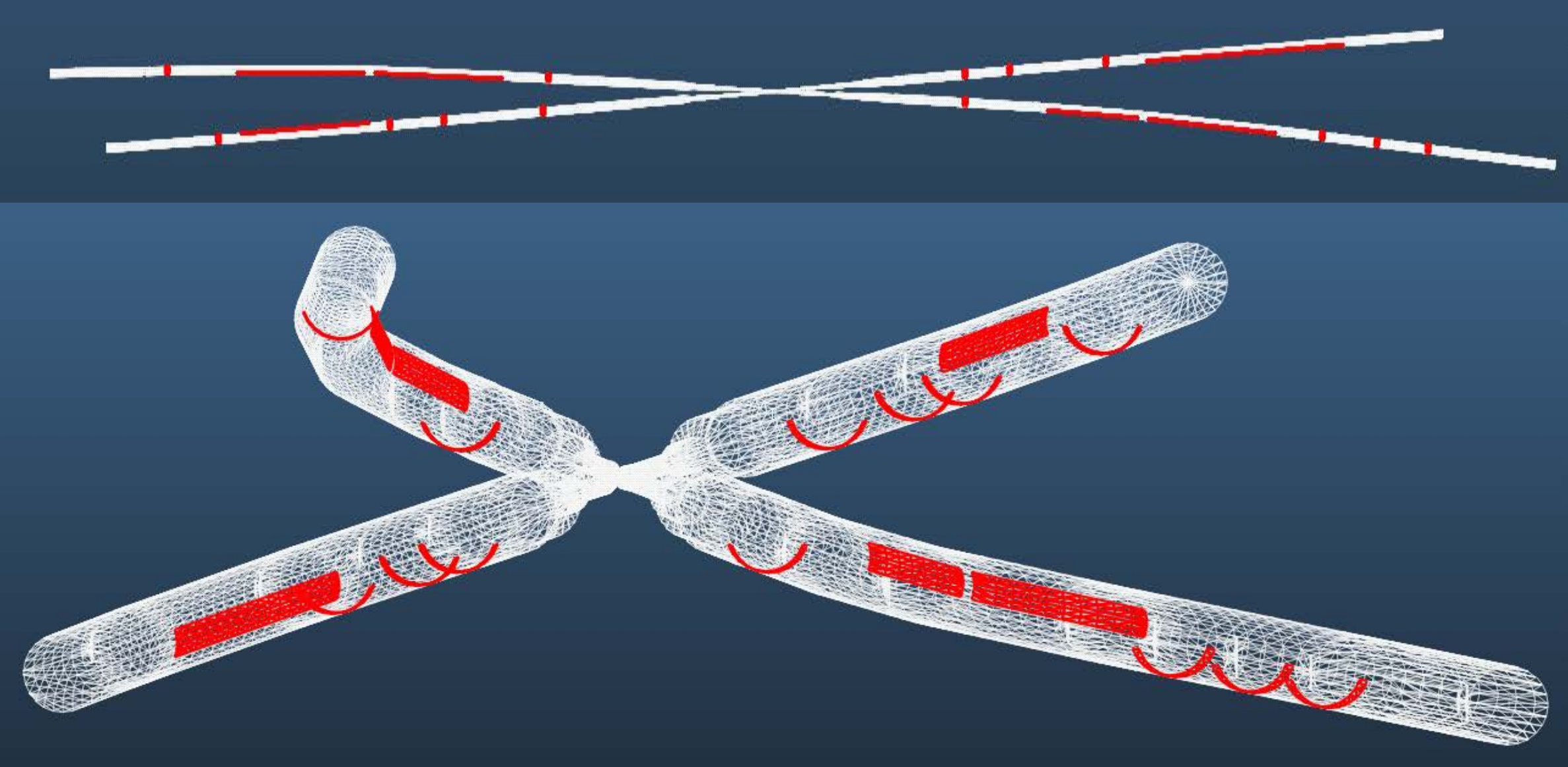

# Modelling magnetic elements in SynRad

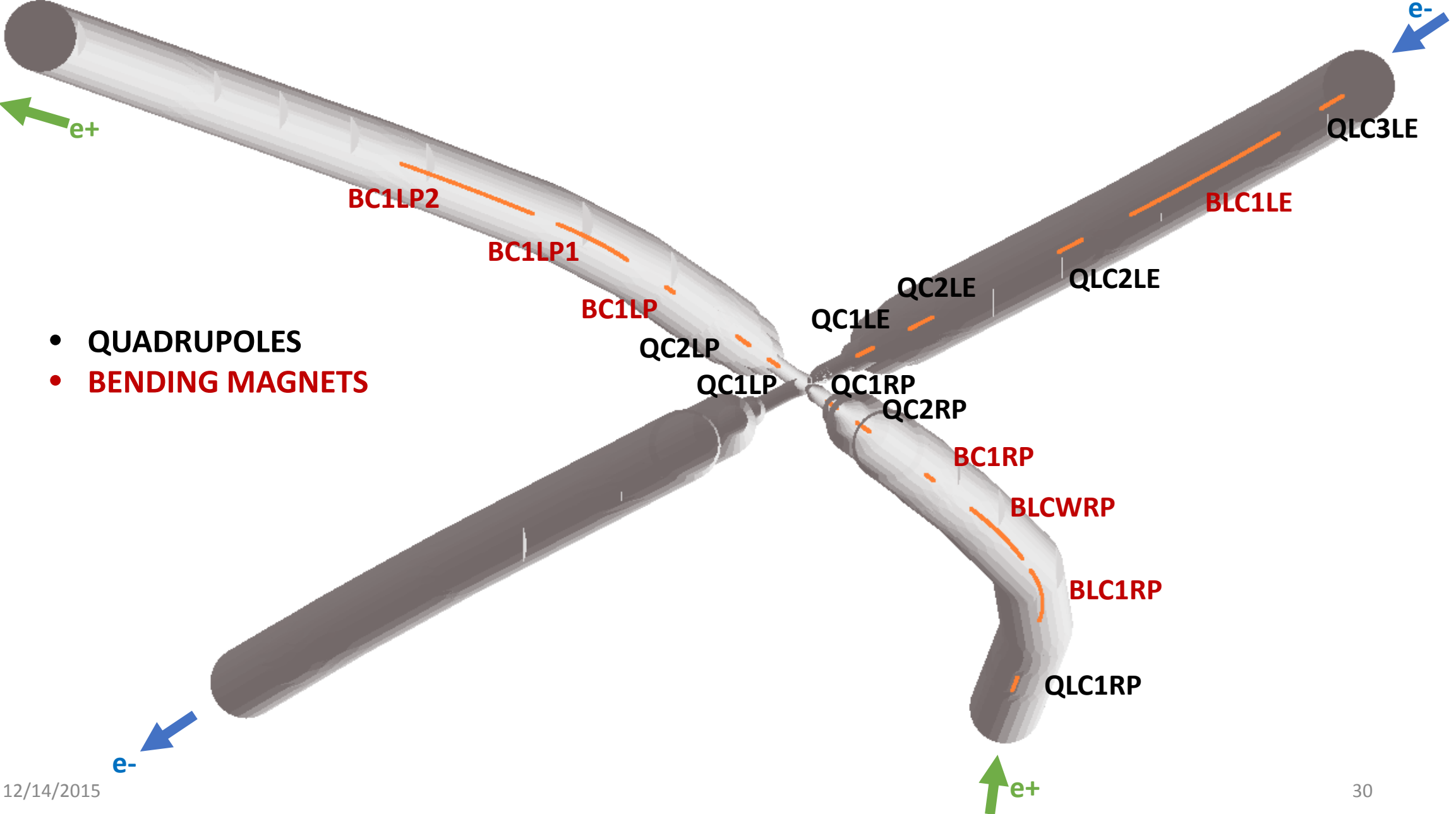

- QUADRUPOLES
- BENDING MAGNETS

# Modelling magnetic elements in SynRad

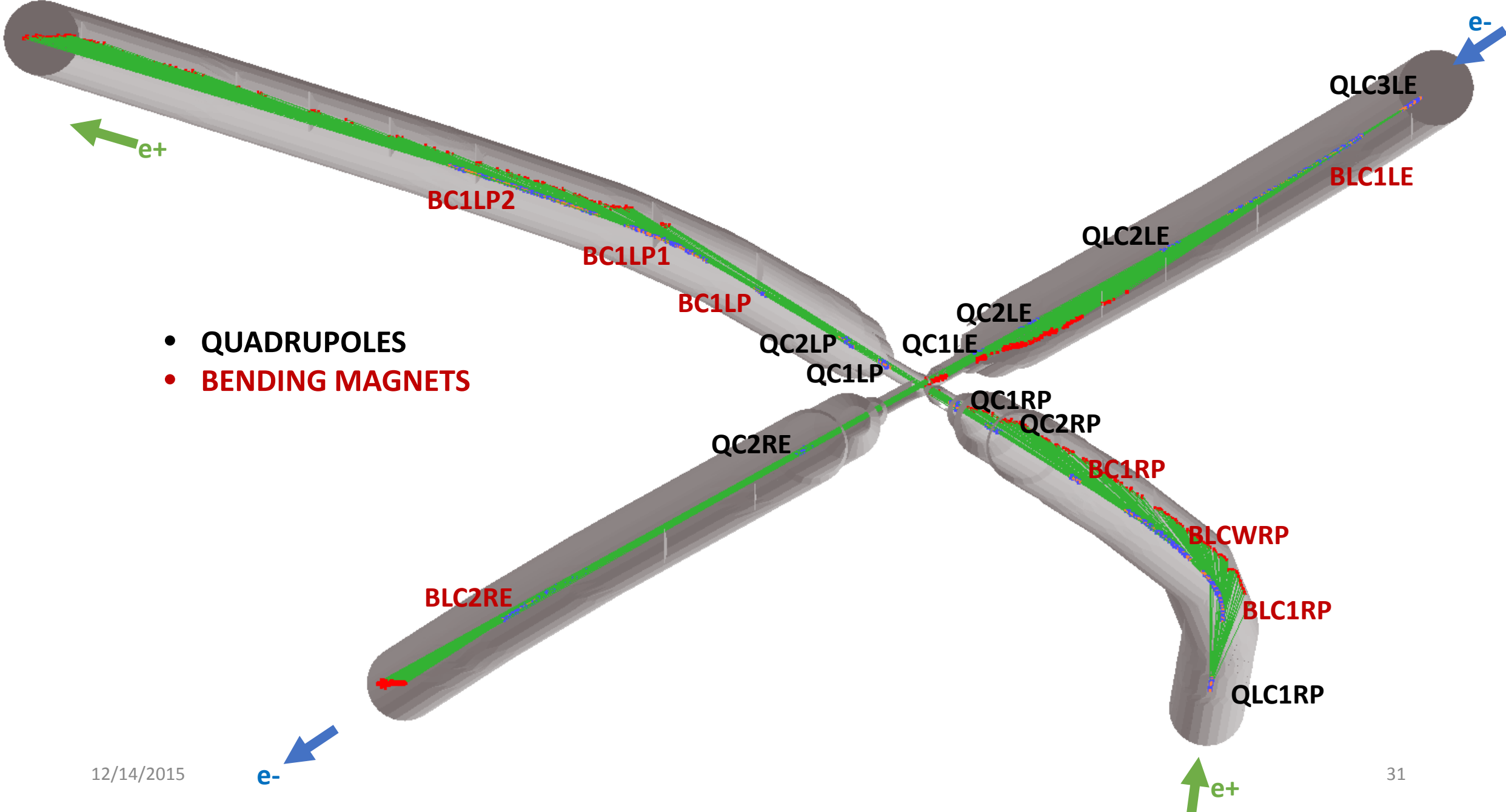

# Photon flux distribution with scattering

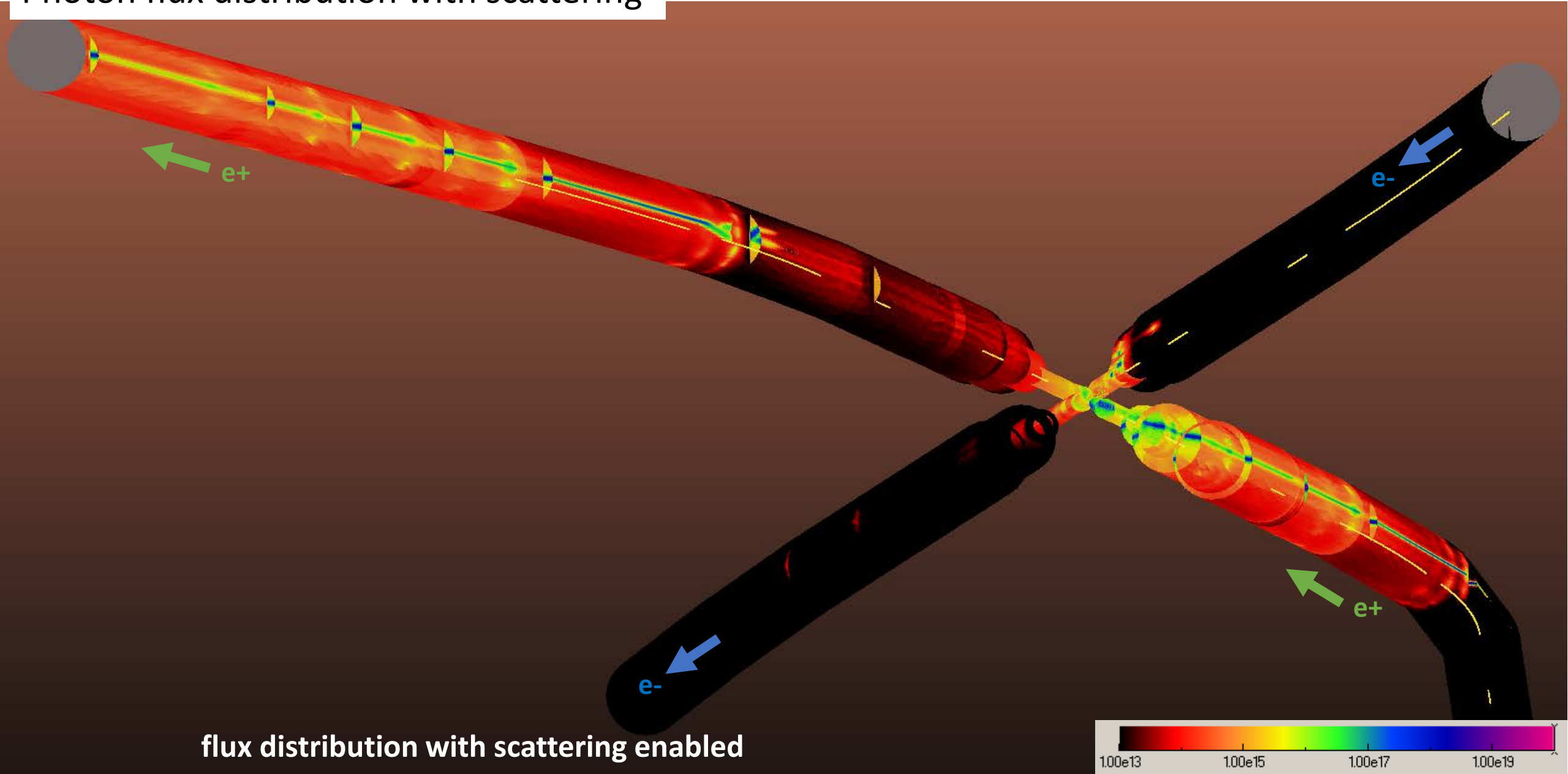

flux distribution with scattering enabled



# Photon stimulated desorption gas loads

- KEK provided PSD measurements from their own chambers with materials such as copper and gold coated tantalum
  - Copper represents 90% of the surfaces we are modelling
- Did not provide details of PSD measurement
  - Assumed conversion factor from alternate round chamber experiment.
  - This could be problematic and a follow-up analysis should look at this first

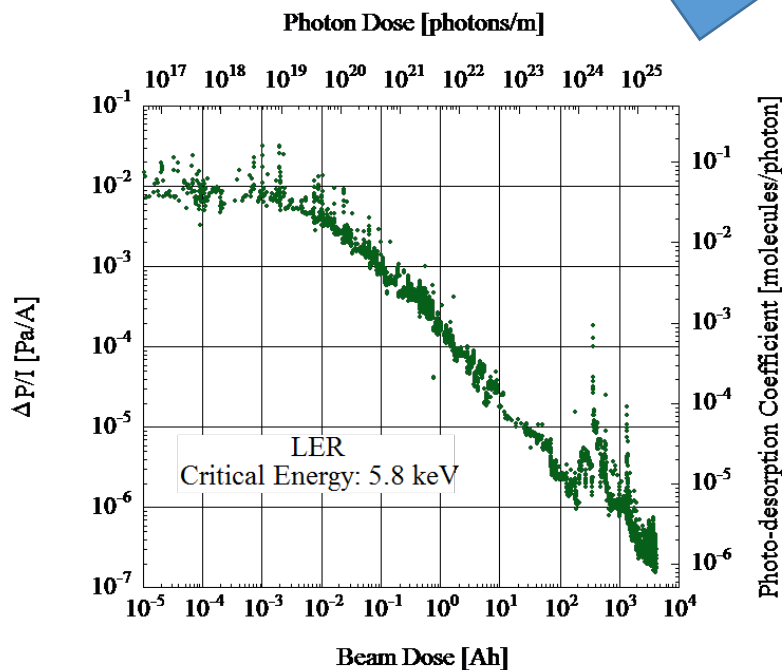

KEK PSD yield measurements for positron line copper chamber

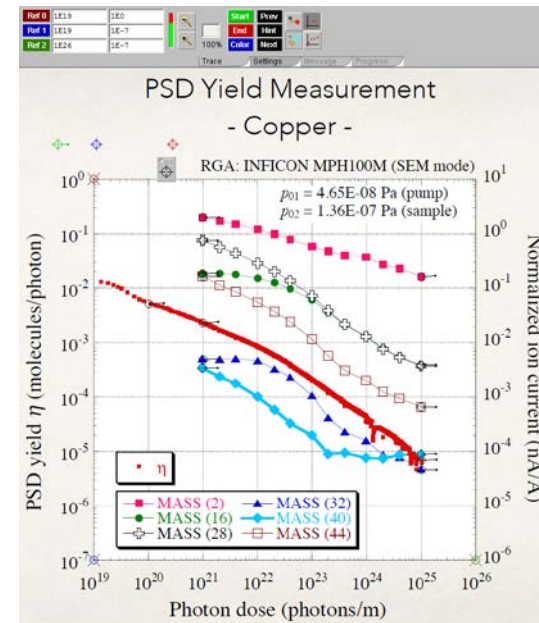

RGA scan from alternate PSD experiment

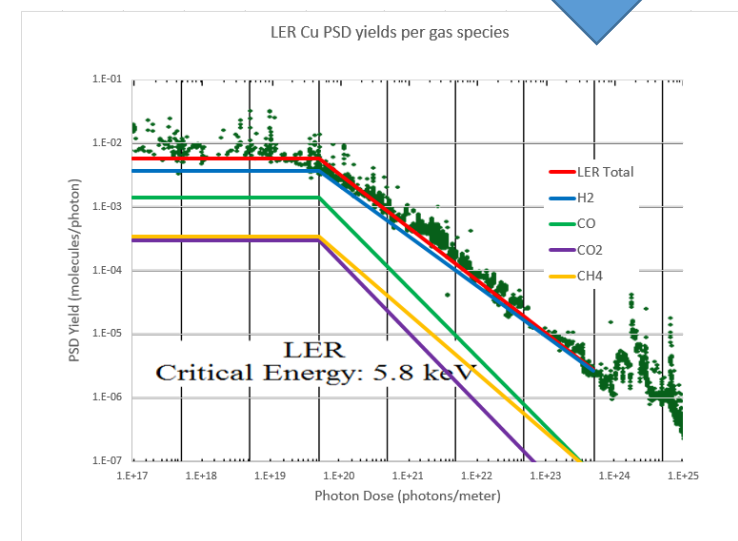

PSD yield per gas species<sup>33</sup>

# Pressure measurements in MolFlow+

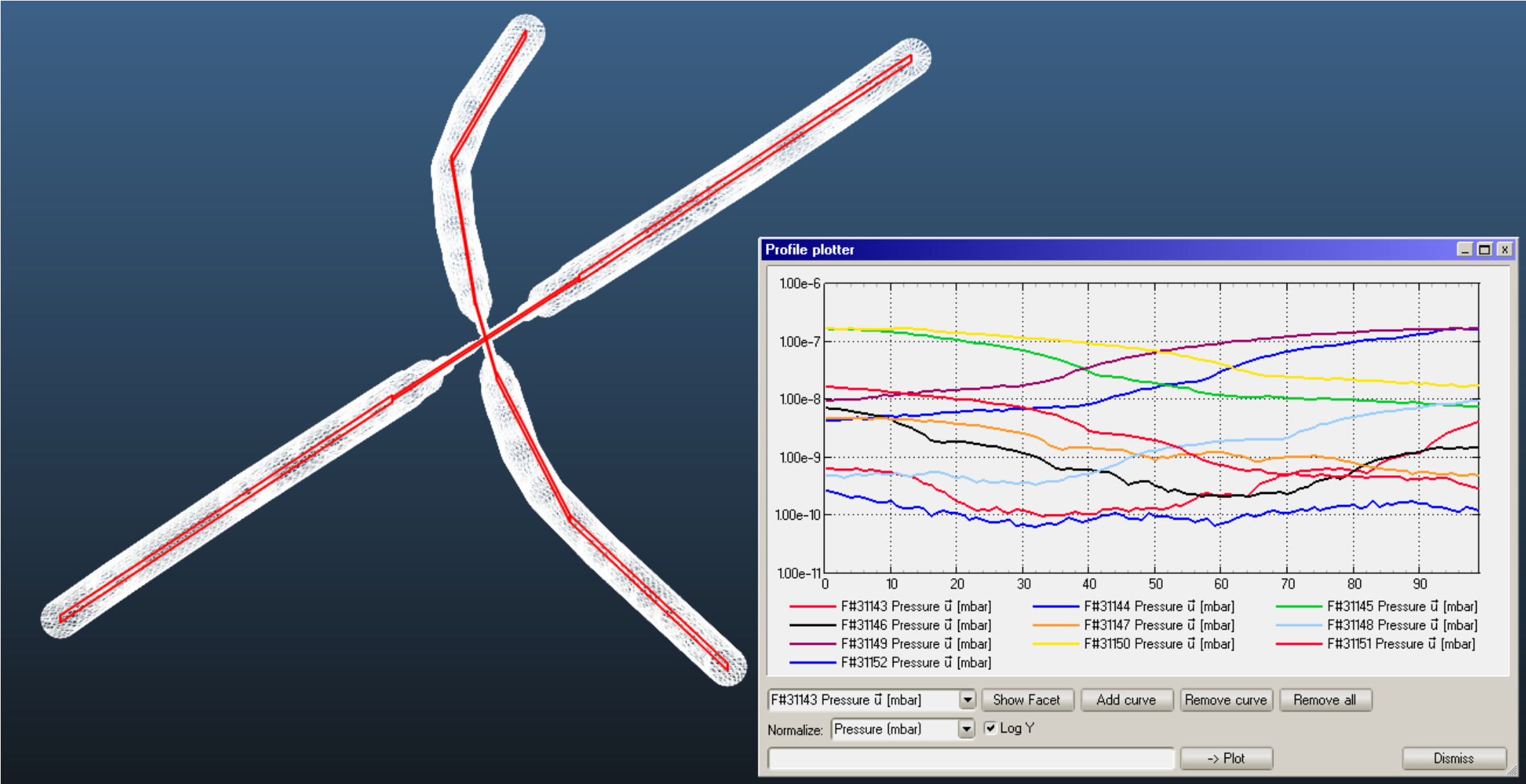

Pressure measured along center of beam for electron and positron lines

Pressure curves are copied and organized in MS Excel

# Positron line pressures

- Peak total pressures on positron line at 1000 A\*hrs occur at interaction point: **7.6E-7 mbar**
- Near the SuperKEKB goal of **6.0E-7 mbar**

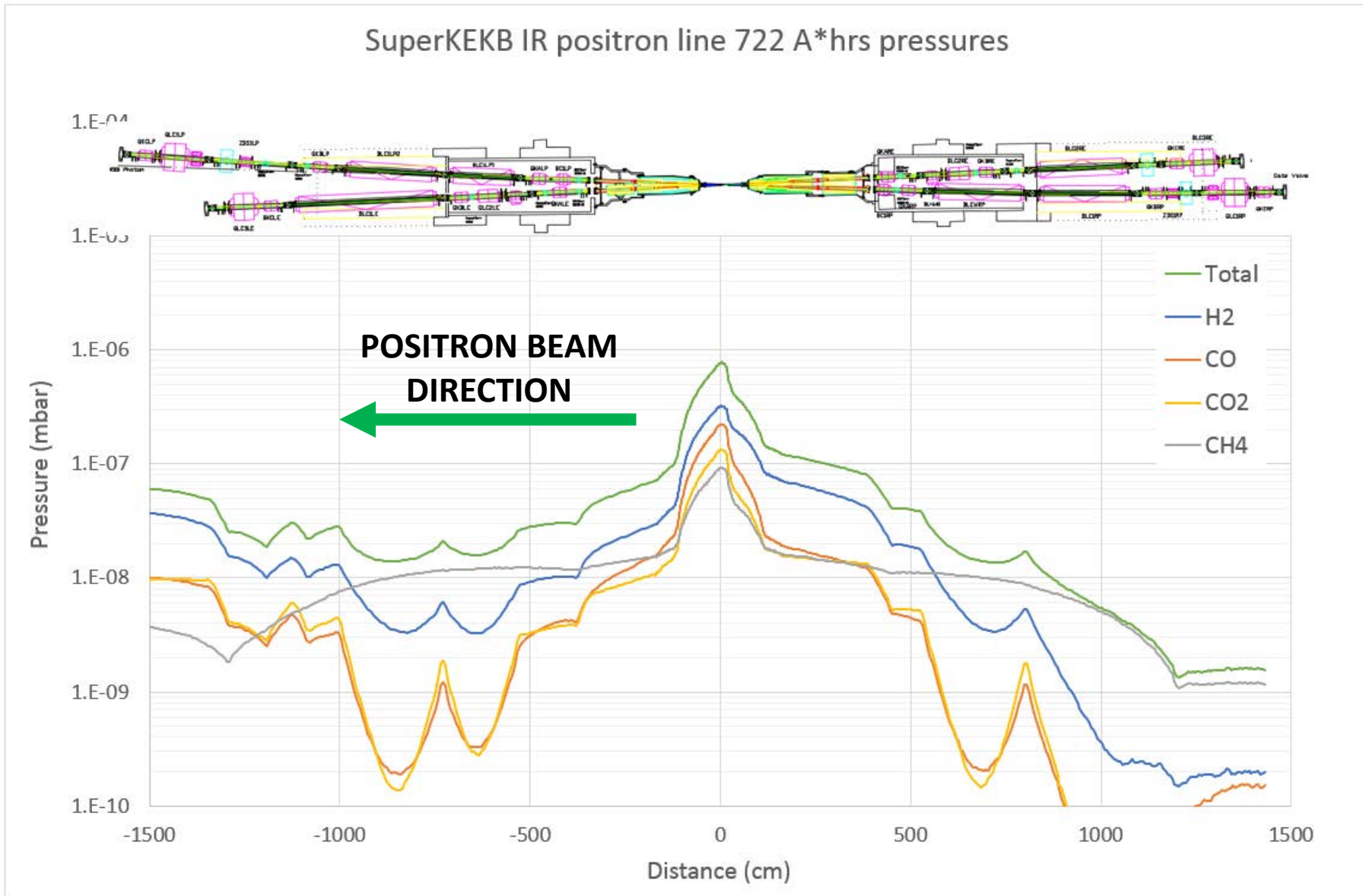

Locations of distributed and isolated pumping elements in red

# Electron line pressures

- Peak total pressures on electron line at 1000 A\*hrs occur at interaction point: **7.6E-7 mbar**
- Near the SuperKEKB goal of **6.0E-7 mbar**

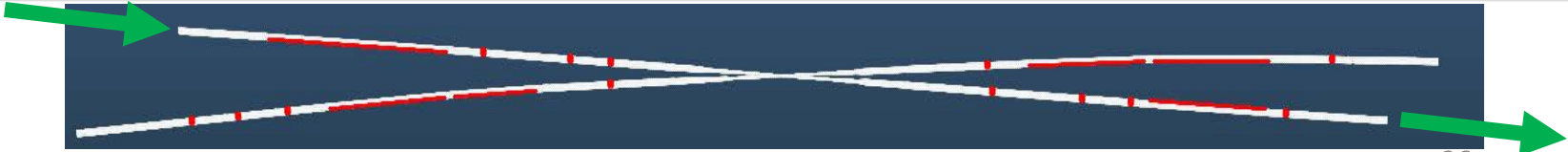
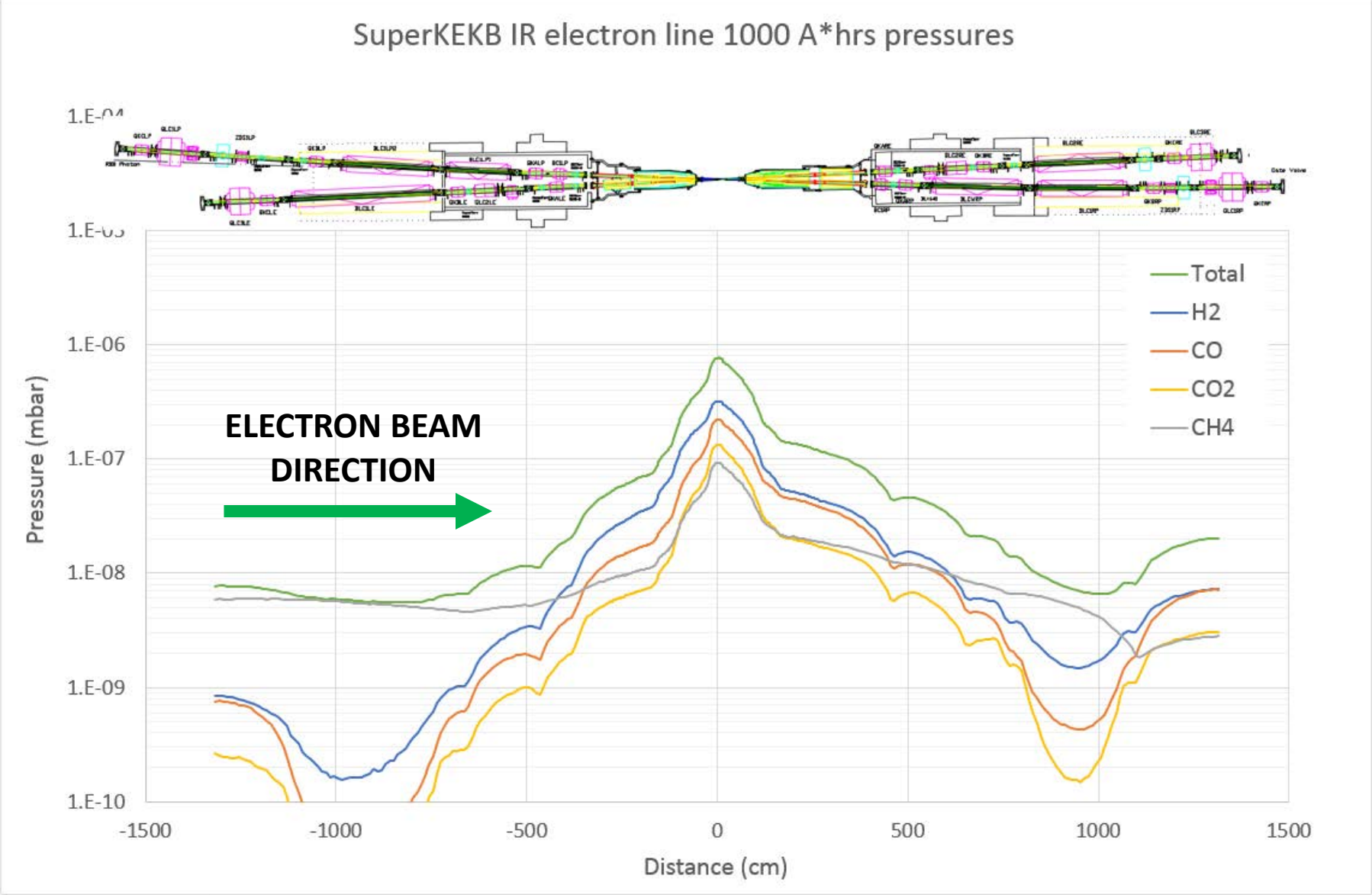

# Pressure evolution

- Peak total pressures @ 100 A\*hrs: 3.6E-6 mbar
- Peak total pressures @ 1000 A\*hrs: 7.6E-7 mbar
- Logarithmic fit prediction to reach 6.0E-7 mbar:  
**16.5 days @ full operating current**  
**1030 A\*hrs for positron line**  
**1410 A\*hrs for electron line**

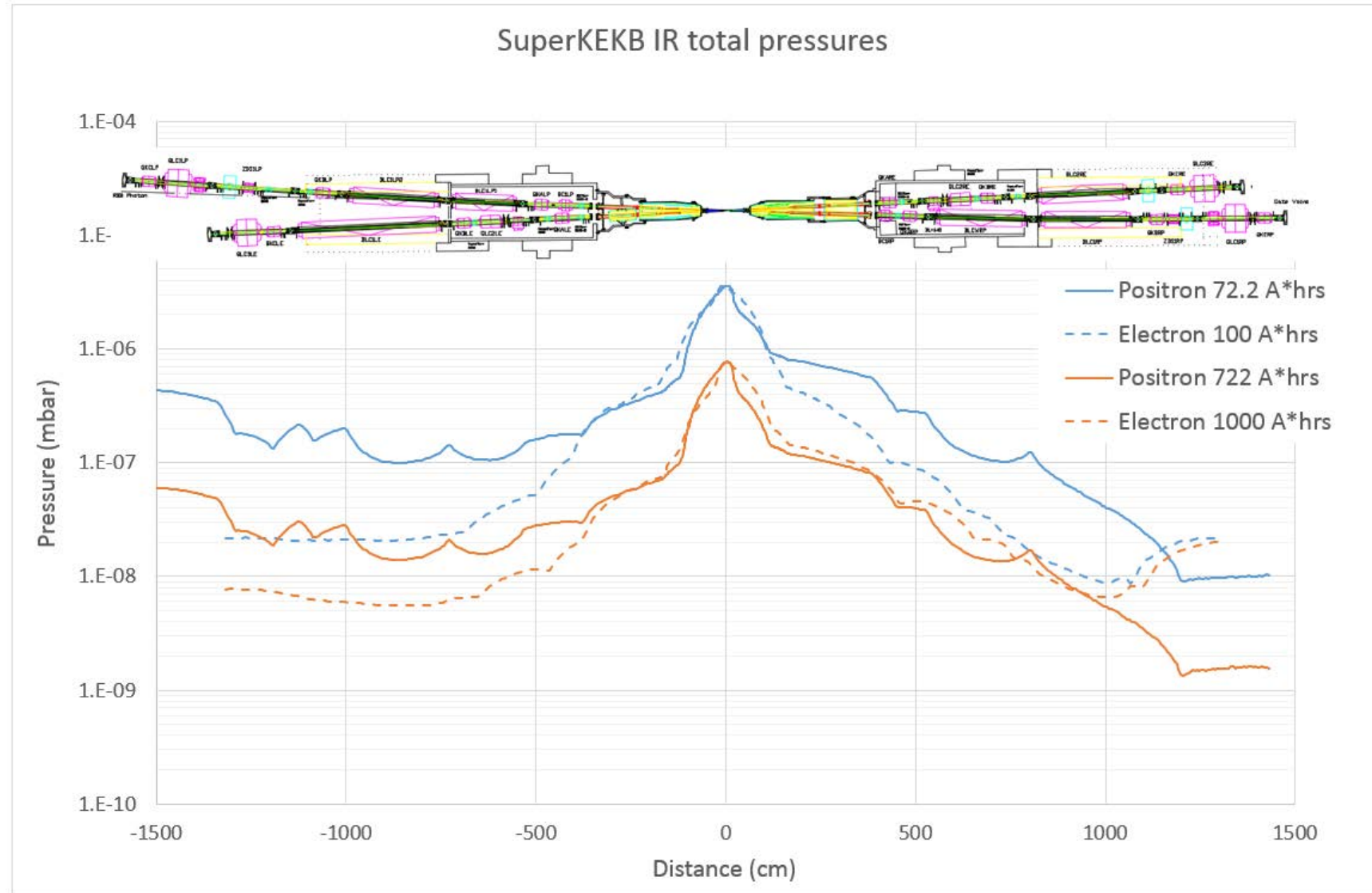

# No scattering vs Scattering

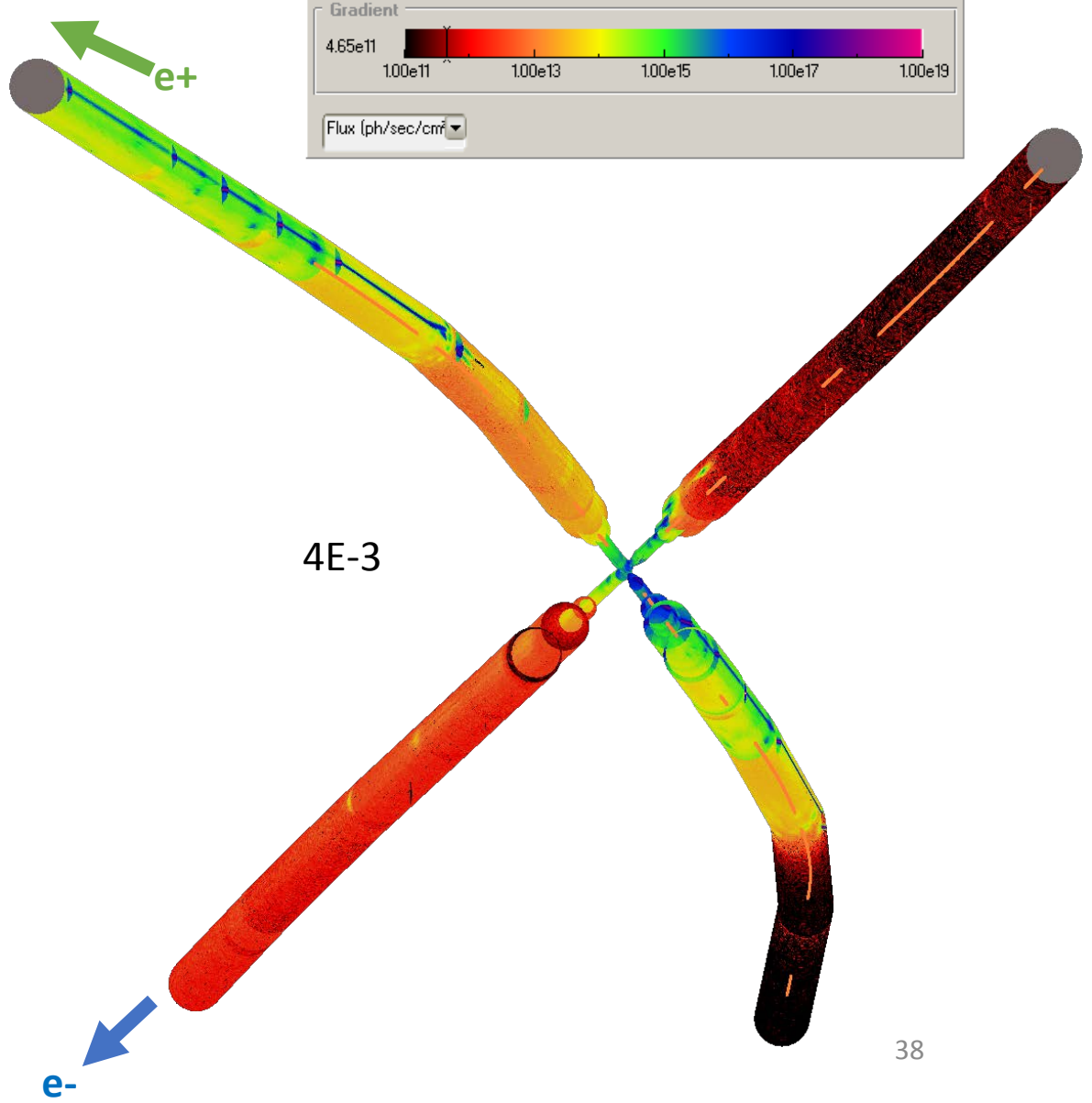
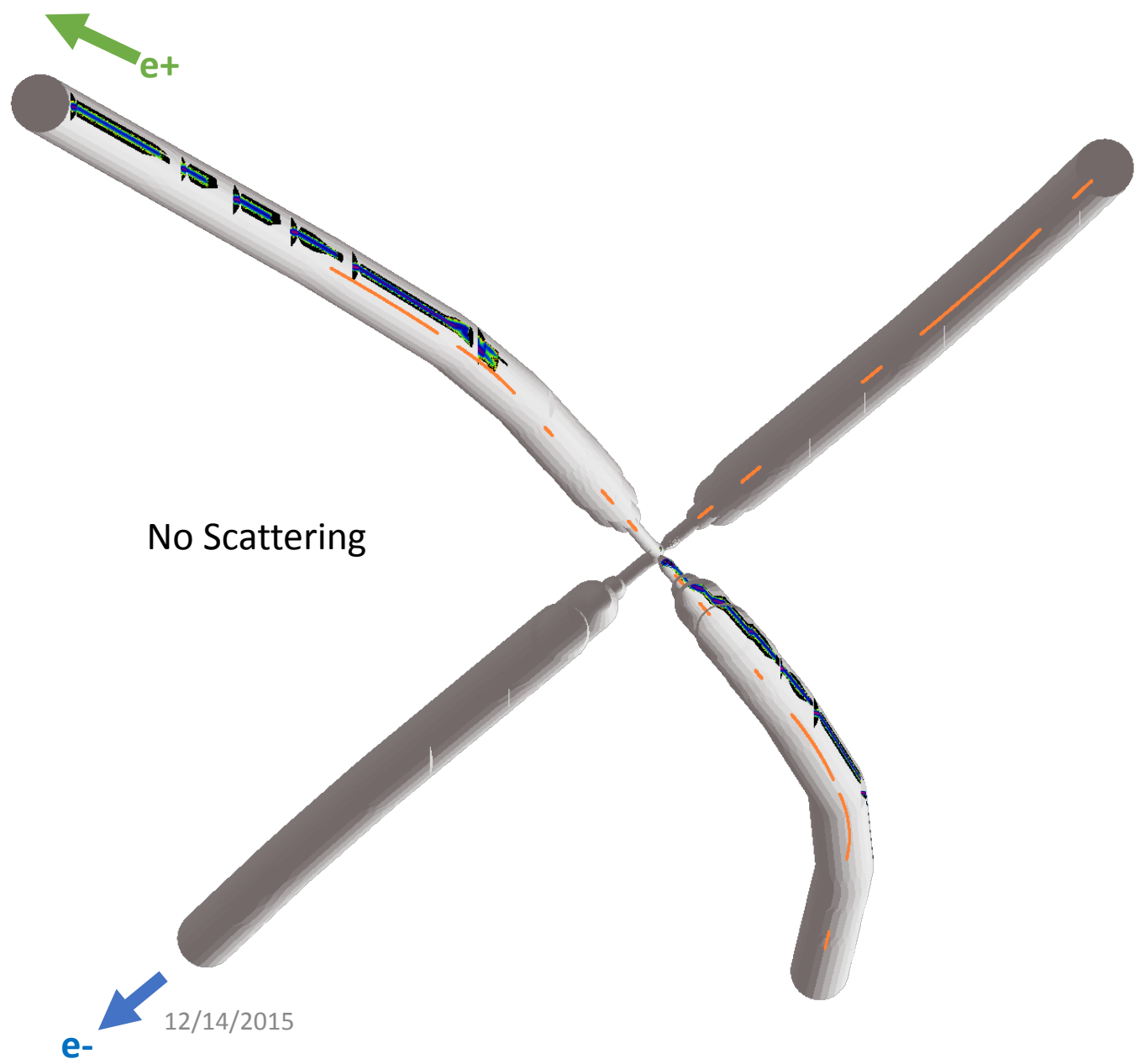

12/14/2015

# No scattering vs Scattering

- Including scattering results in a total outgassing value **13x higher** than with no scattering

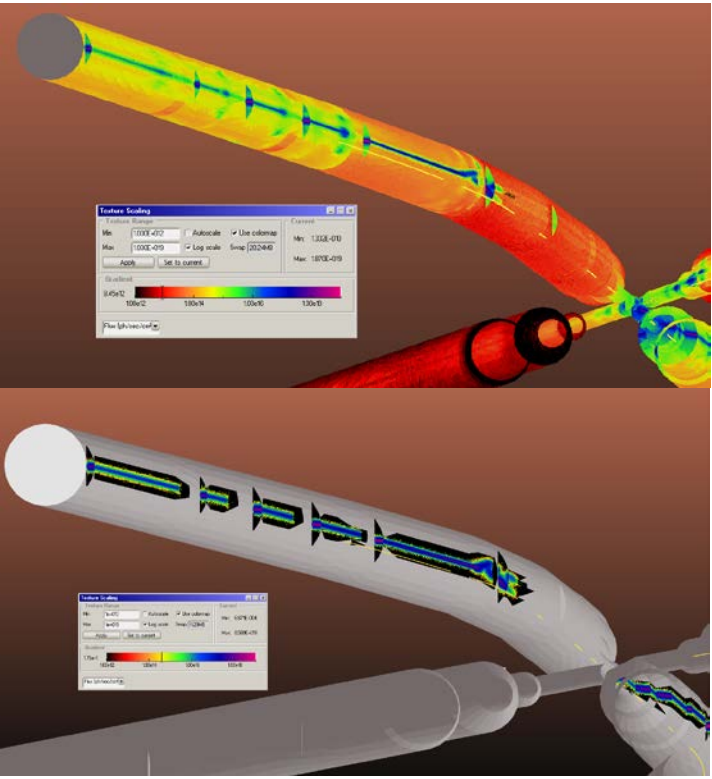

SynRad flux densities in equal log scale with scattering (above) and without (below)

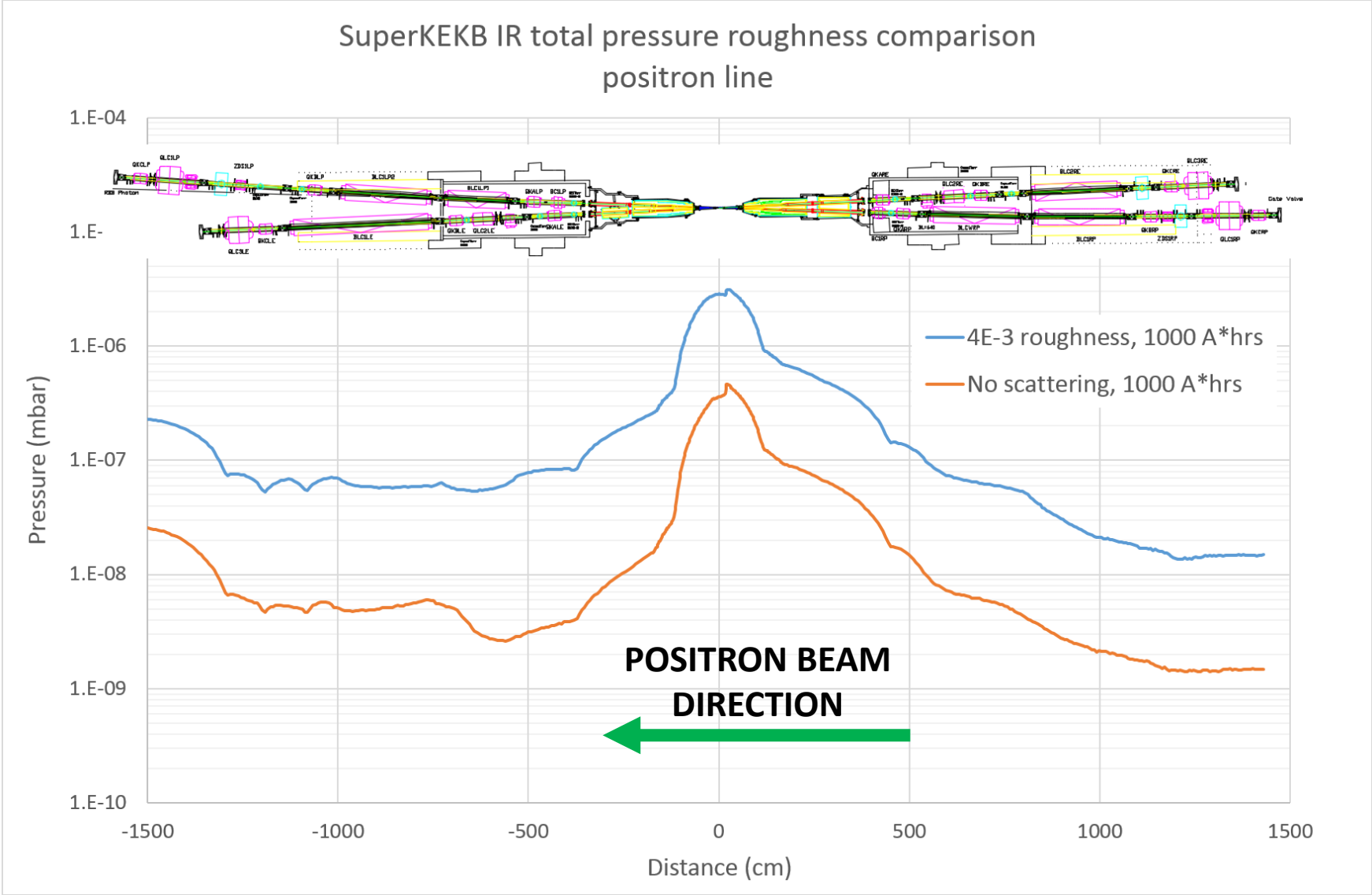

# Roughness comparison

- SynRad roughness ratio defined as:  
RMS roughness / correlation length
  - Higher value = rougher surface
- Chosen ratio for these studies employed uniformly for all surfaces

Texture Scaling dialog box with the following fields:  
Texture Range: Min: 1.000E+01, Max: 1.000E+019, Autoscale: unchecked, Use colormap: checked, Log scale: checked, Swap: 20.24MB, Current: Min: 1.251E-005, Max: 8.476E+018.  
Gradient: 4.65e11 to 1.00e19 color scale.  
Flux (ph/sec/cm<sup>2</sup>) dropdown menu.

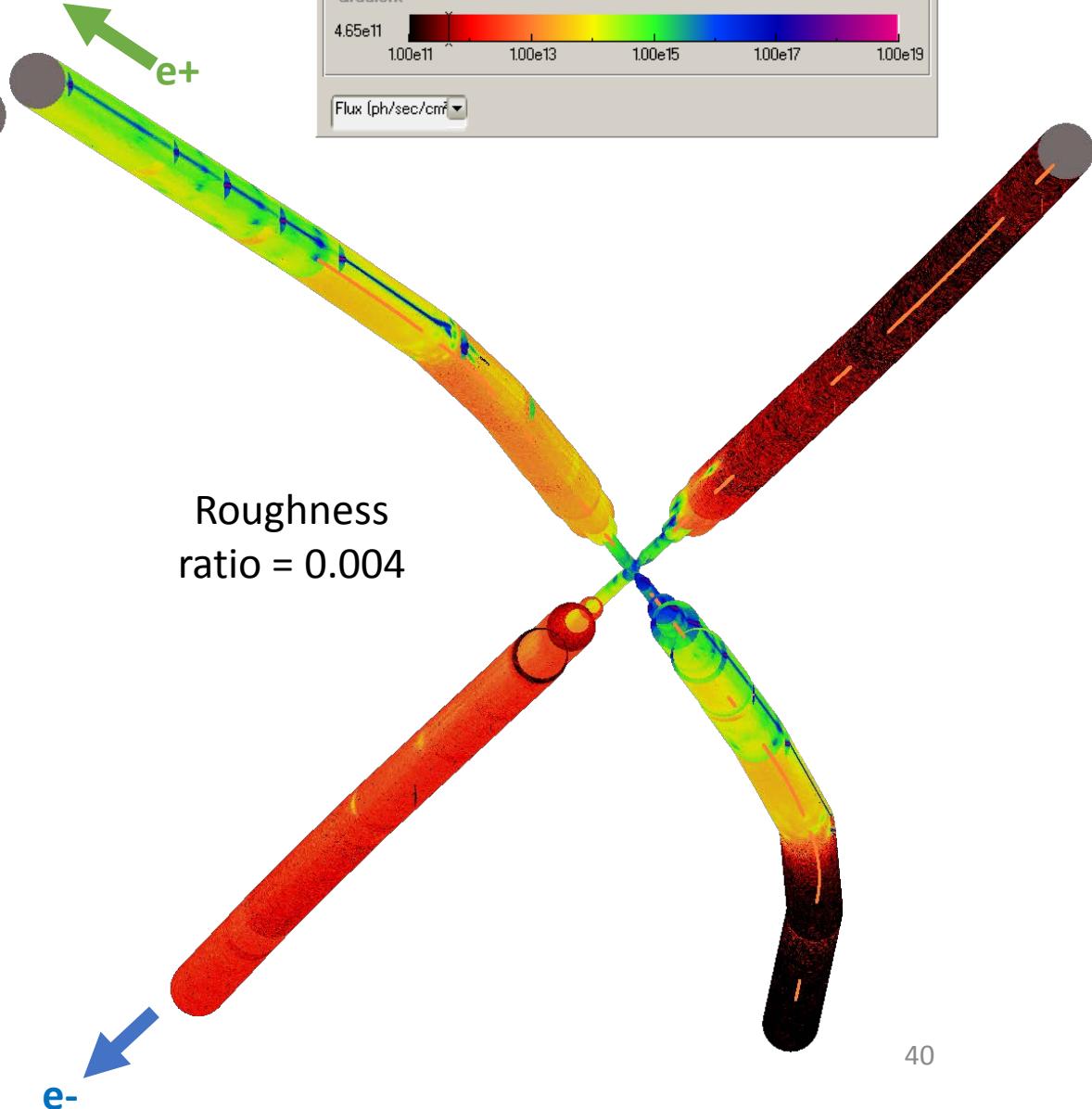
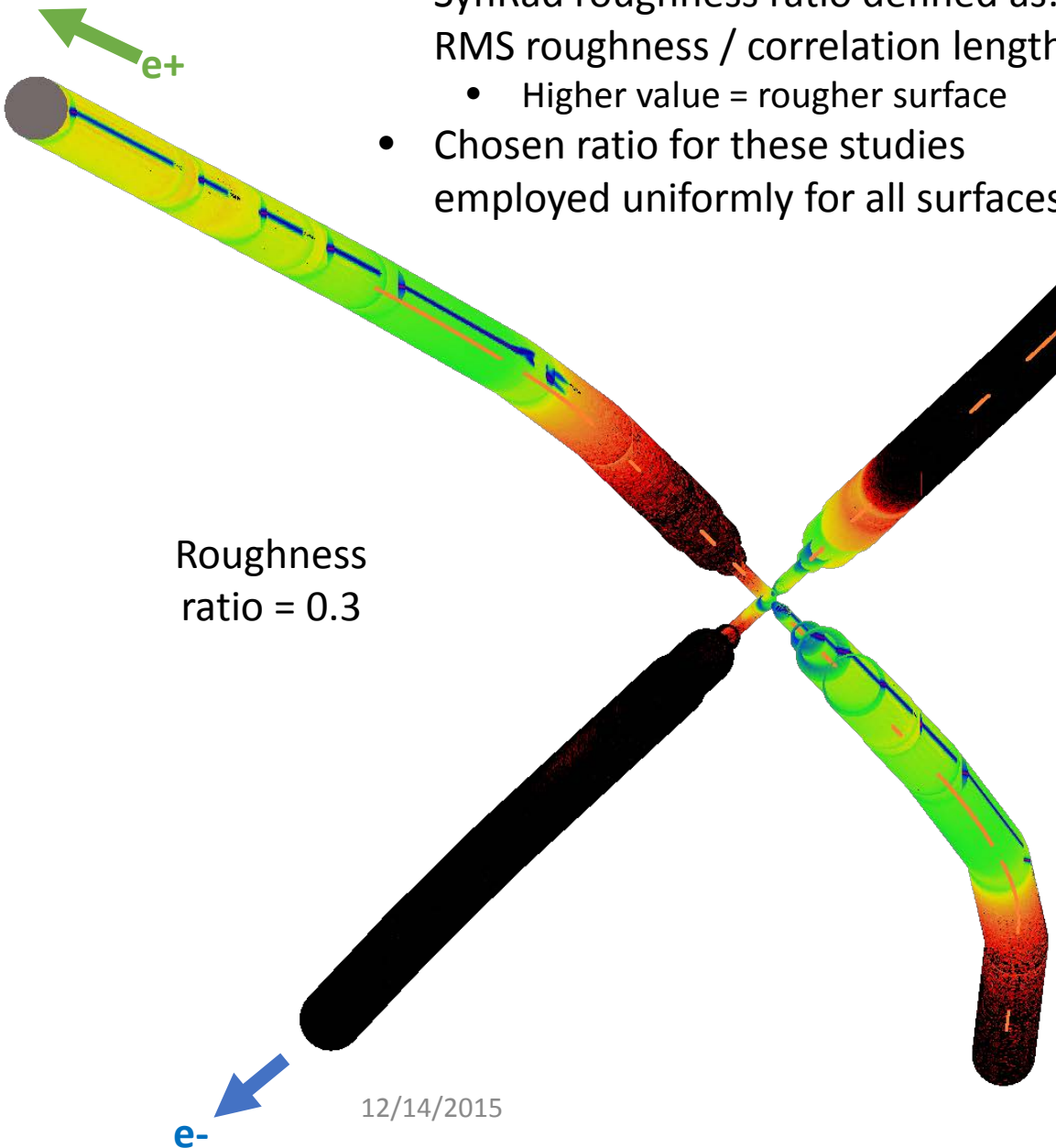



# Roughness comparison for H<sub>2</sub> pressures

- Total PSD outgassing values for each ratio within 5% of each other
- Smoother surfaces (lower ratio) leads to more scattering of photons in downstream direction and thus higher pressures
- Final results reported for a KEK preferred ratio of 0.02

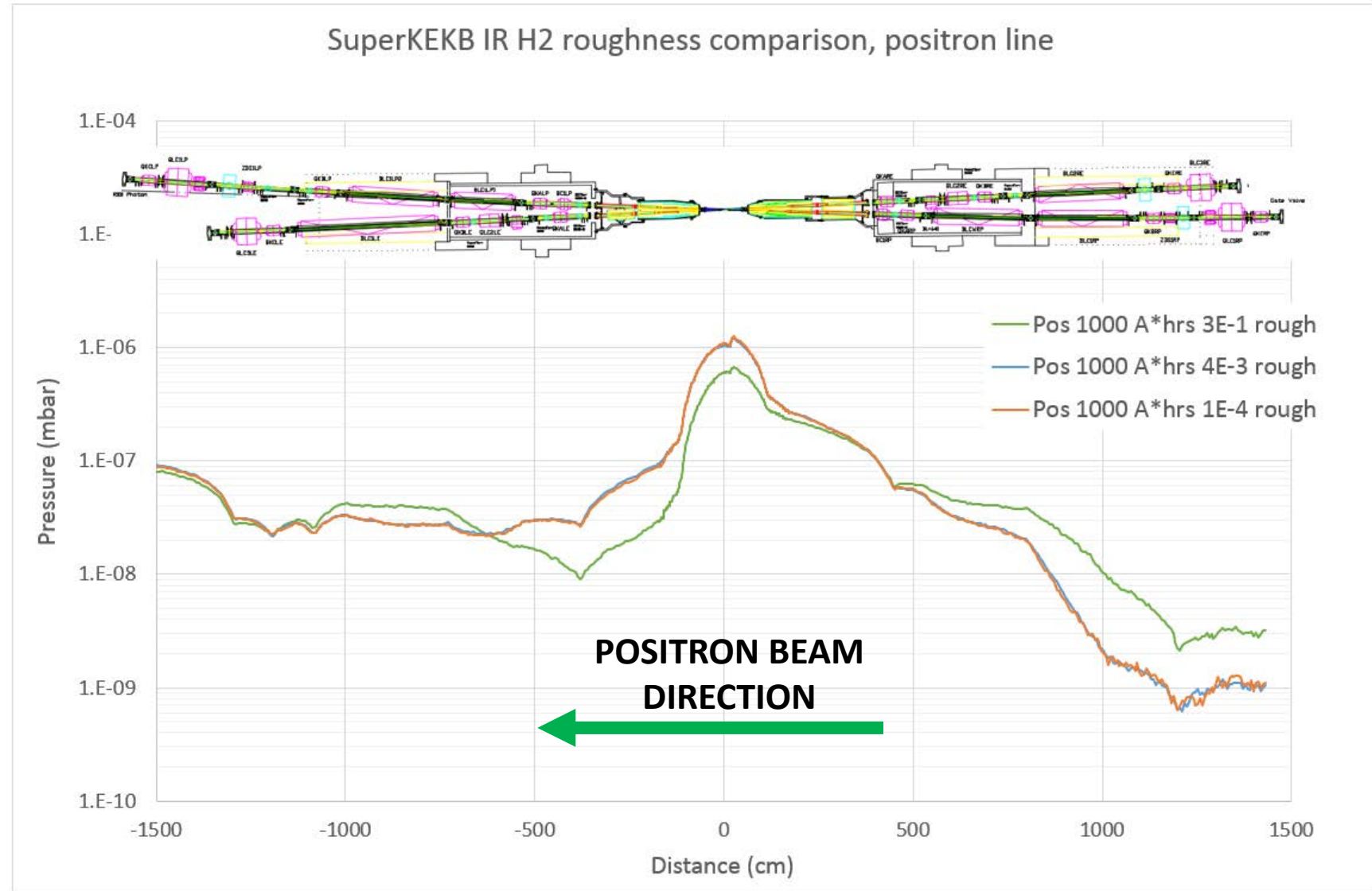

# Conclusions

## SuperKEKB

- Calculated pressures are close to prediction in SuperKEKB design report
- Vacuum simulations with photon scattering leads to more conservative estimation of conditioning times
- Choice of photon scattering seems to have less influence on pressure predictions
- PSD conversion maps are loosely defined and should be looked at
- Hoping to learn much from their upcoming startup and conditioning

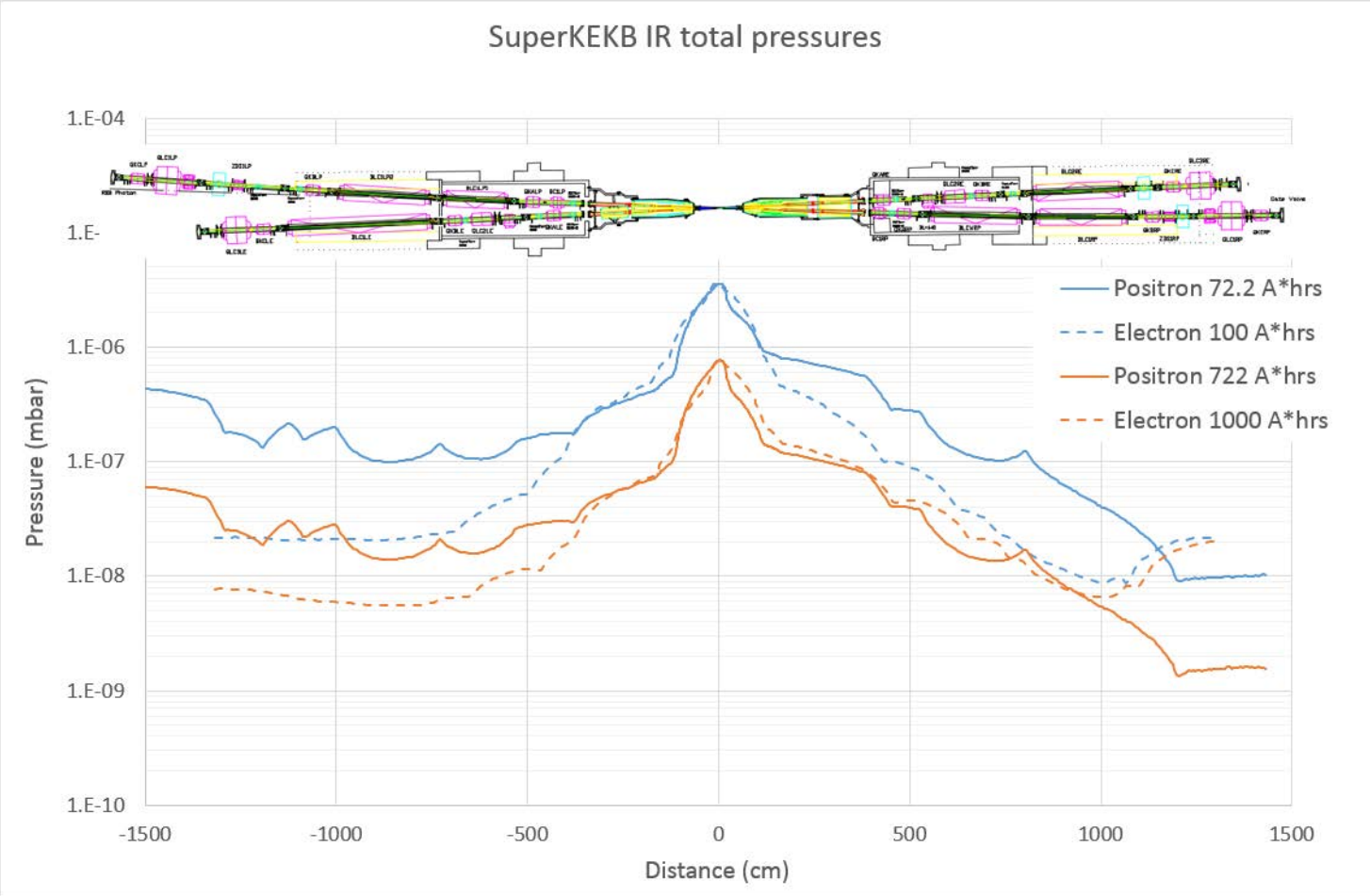

# Advanced Photon Source (APS) and APS-Upgrade project

## APS-Upgrade Project

- Upgrade storage ring with multi bend achromat lattice for higher brightness
- 6 GeV, 200 mA
- Completion in 2020

## Storage ring vacuum system goals

- 2 nTorr average pressure and 30 hour beam lifetimes @ 1000 A\*hrs conditioning
  - 208 days full current operation

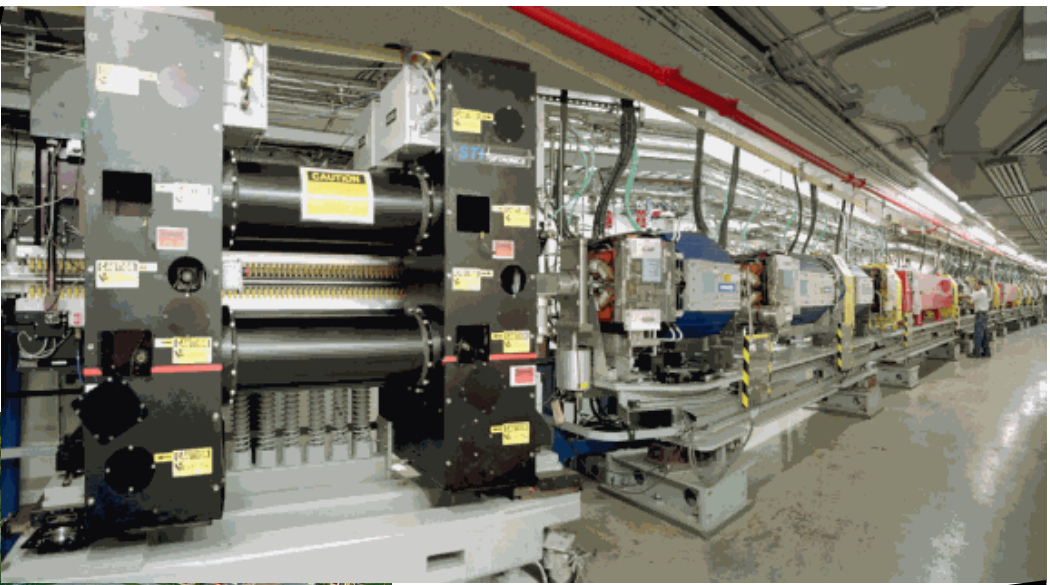
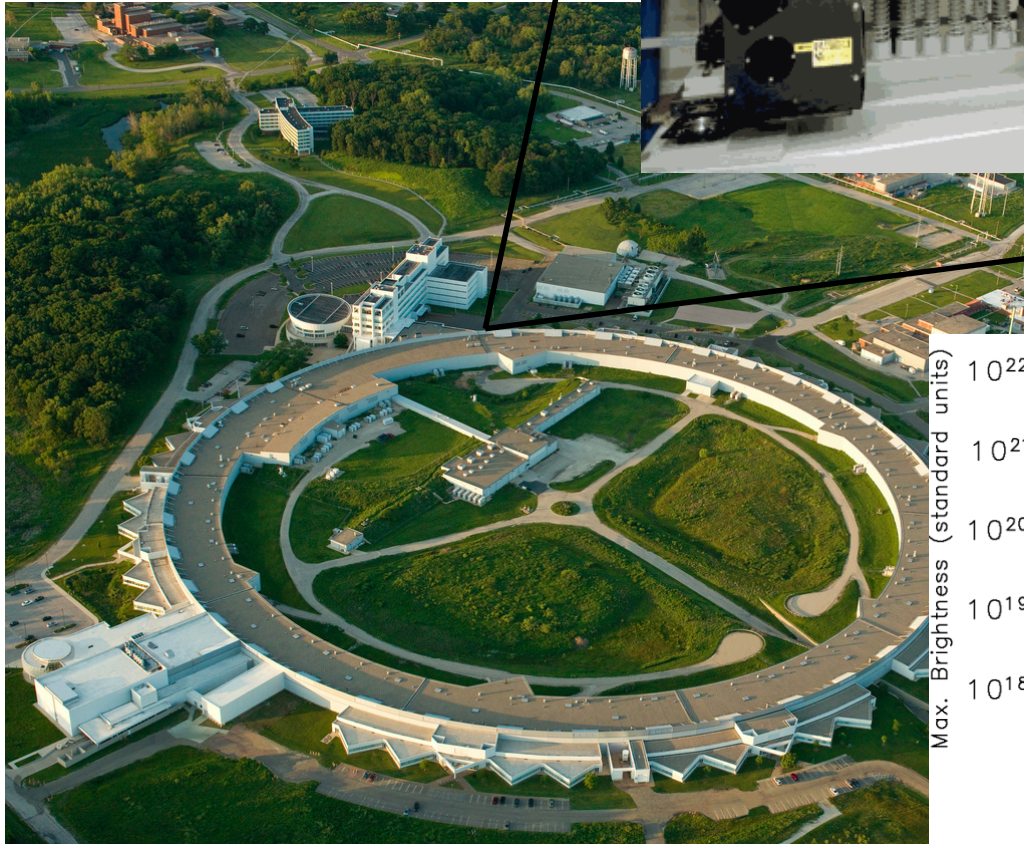

Advanced Photon Source site

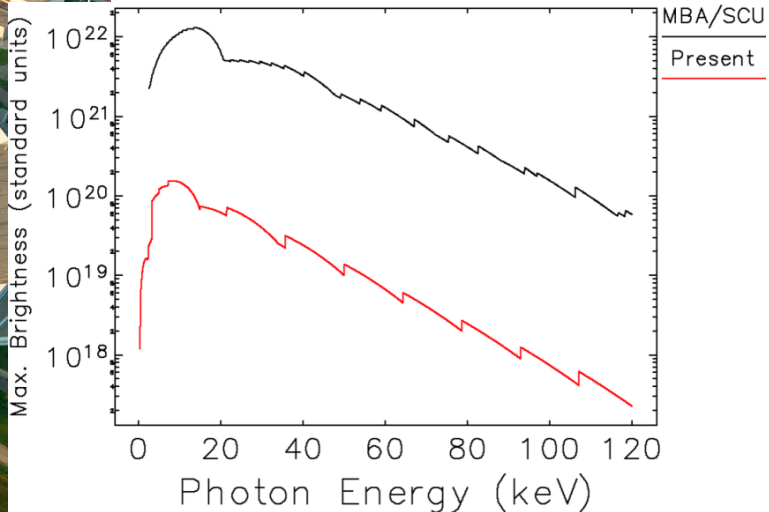

Enhanced brightness of APS-U

# Vacuum system design for a typical sector

- 40x total 27.5 meter long sectors, 27 chambers per sector
- 22mm electron beam aperture
- Magnet design
  - L-bends – bending magnets
  - Multiplets – quadrupoles
  - FODO section – focusing/defocusing
  - Straight section (downstream, not shown) – undulators
  - Quad doublets – incorporate fast correctors
- Vacuum pumping from a variety of elements
  - NEG strips in extruded L-bend and straight section antechambers
  - NEG coating in central FODO section
  - 7x discrete cartridge pumps

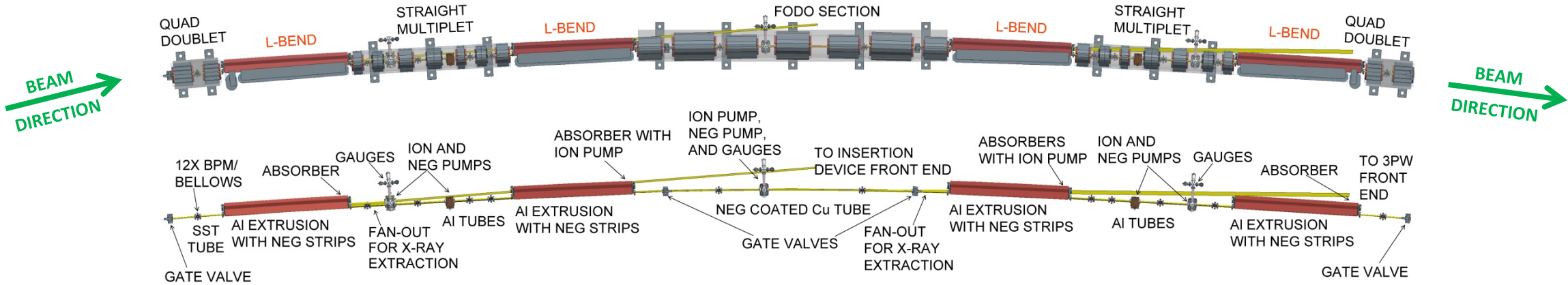

Magnet lattice (top) and vacuum system (bottom) for a typical sector of APS-Upgrade storage ring

# Vacuum system design for a typical sector

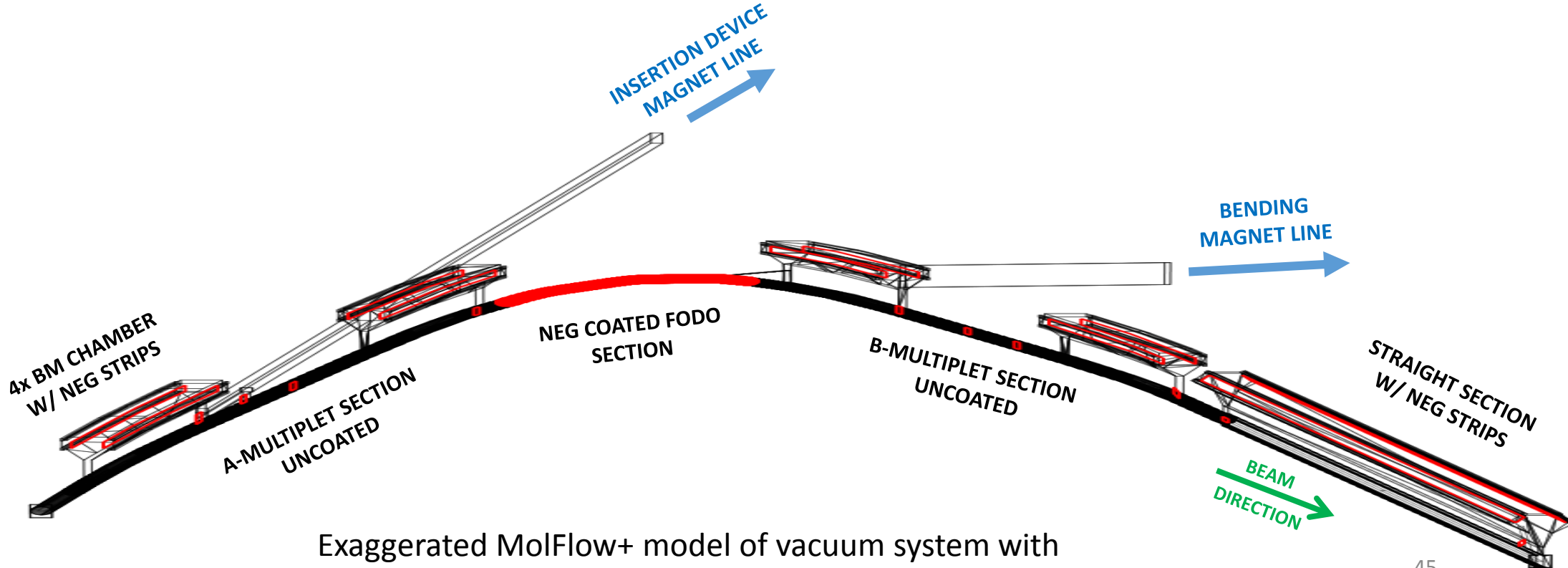
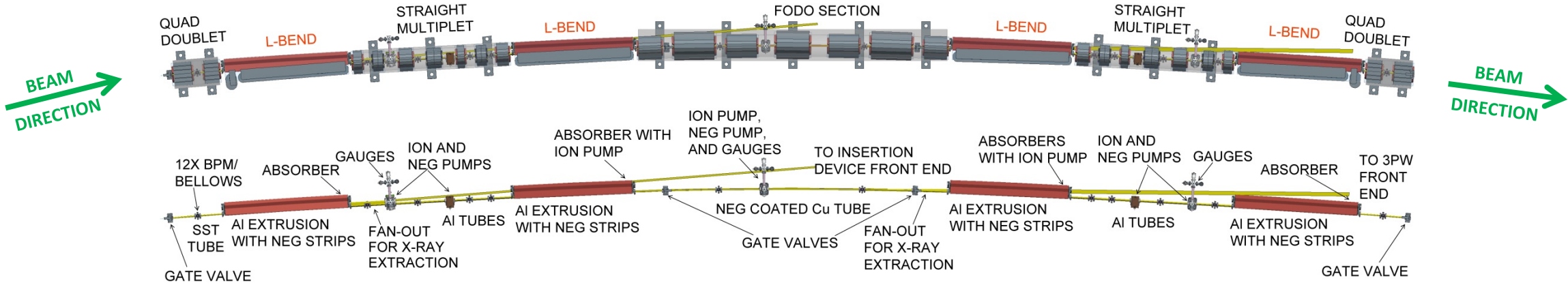

Exaggerated MolFlow+ model of vacuum system with pumping elements highlighted in red

# Building a 3D model

- Vacuum system CAD model created with nearly identical steps to SuperKEKB model
- Model represents one sector of storage ring
- 3D CAD model represents the interior volume of vacuum system
- Includes absorber geometry to capture the ray trace
- Captures varying conductance of vacuum chamber elements
- Pumping ports are simplified for now with room to design beam screens later

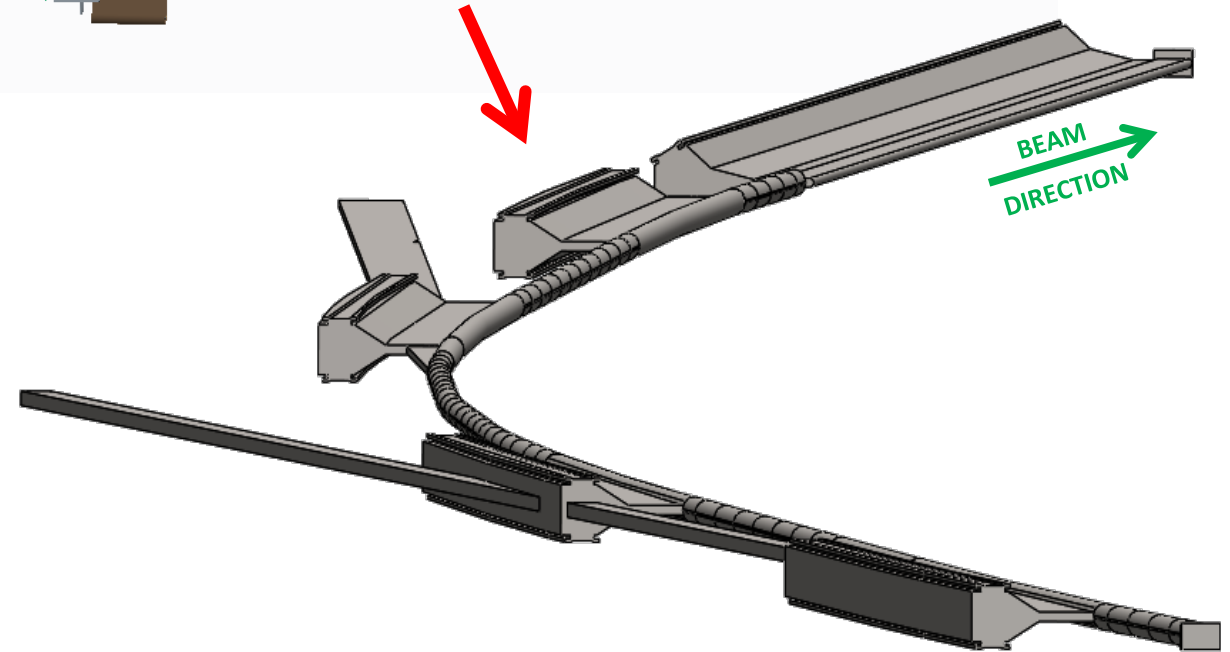
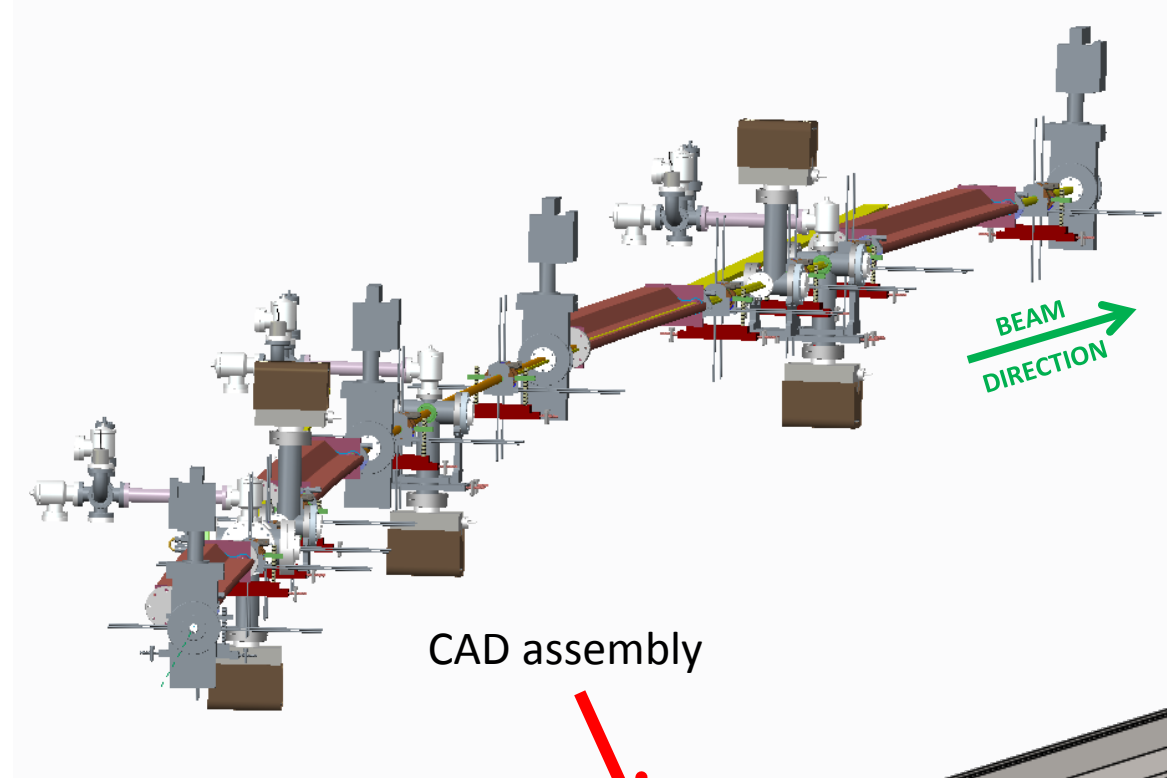

# SynRad simulation

- Photon scattering leads to irradiation of all surfaces
- Symmetric boundary condition passes downstream photons to the upstream in order to reflect the repetition of sectors
- Insertion device and bending magnet off shoots are currently undefined and not included in the model
- Majority of photons captured at absorbers located near pumps
- FODO section absorbs 35% of 11 kW total flux per sector within round 22mm aperture chambers

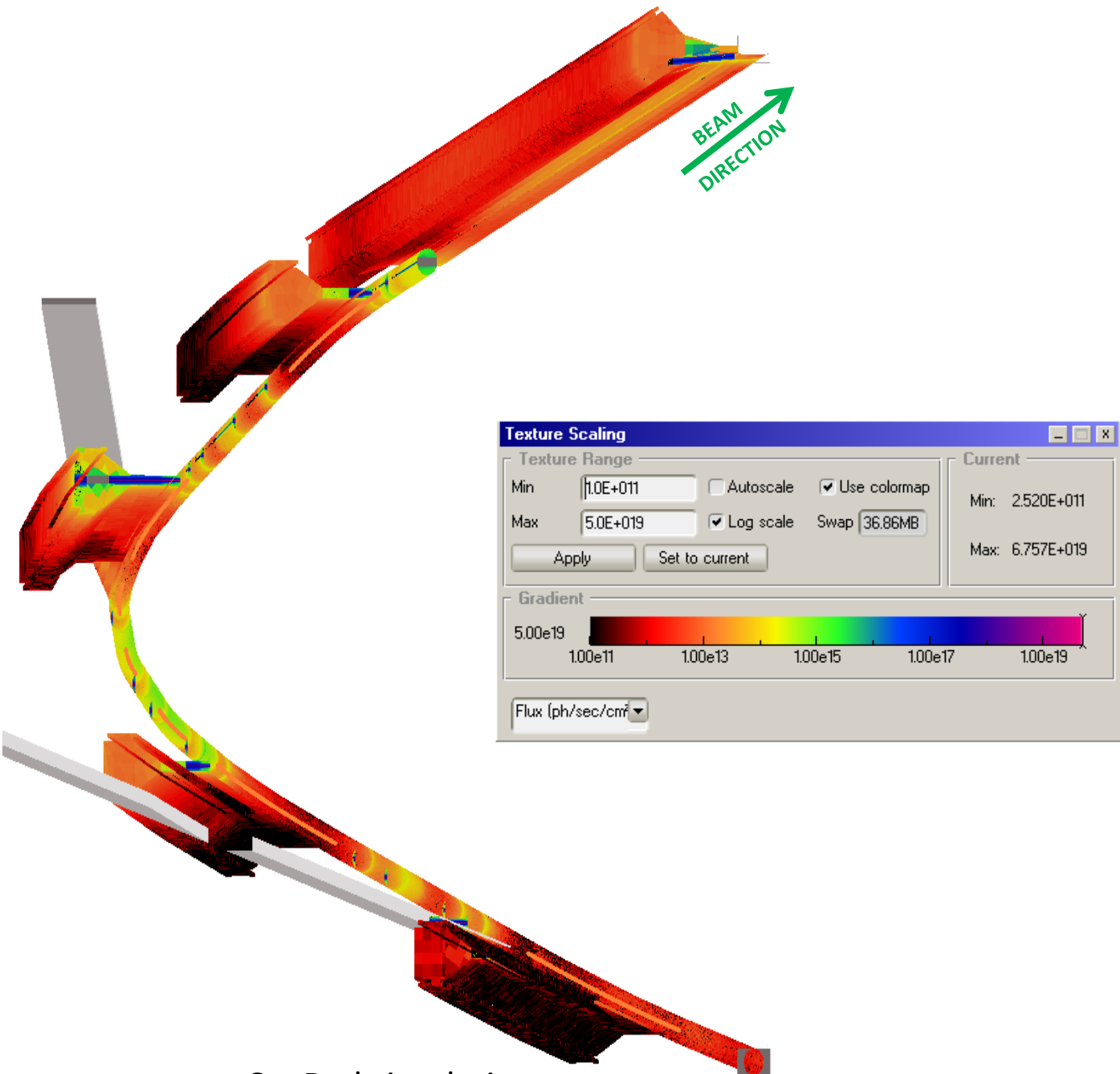

# Predicting PSD gas load

- PSD measurement experiments recreated for all metals within vacuum system:
  - Aluminum, OFE copper, Cu-Plated SST measurements from C.L. Foerster papers
  - NEG coated stainless steel from P. Chiggiato, R. Kersevan assumed to apply to NEG coated copper
- Experiments recreated with and w/o photon scattering
  - Corresponding maps are **more conservative** w/o scattering
  - First analyses will include conservative maps. Follow-up will consider less conservative map as possible lower bar of potential vacuum performance...

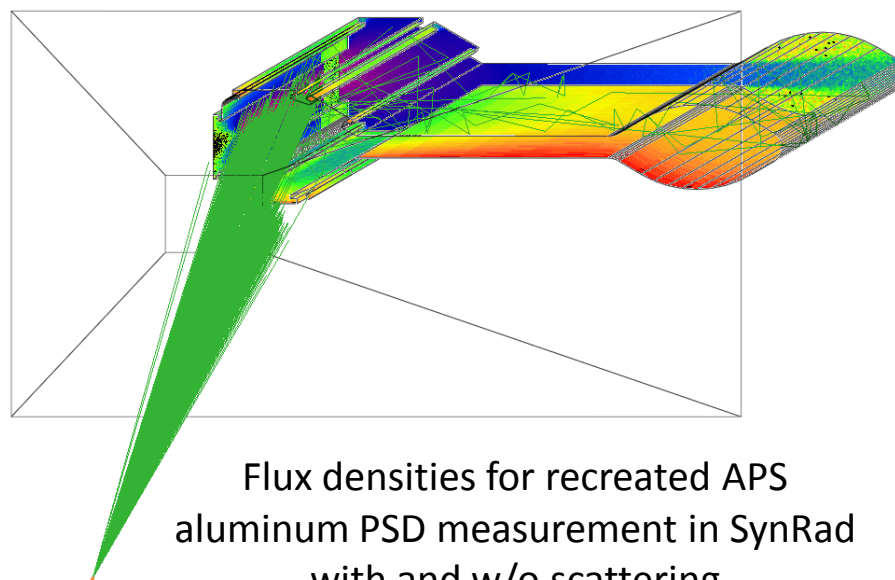
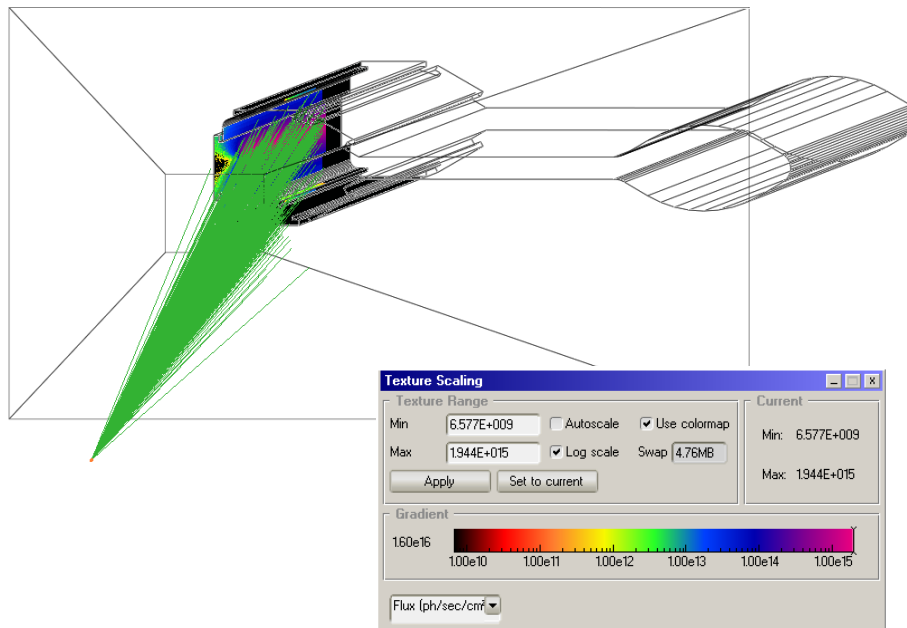

Flux densities for recreated APS aluminum PSD measurement in SynRad with and w/o scattering

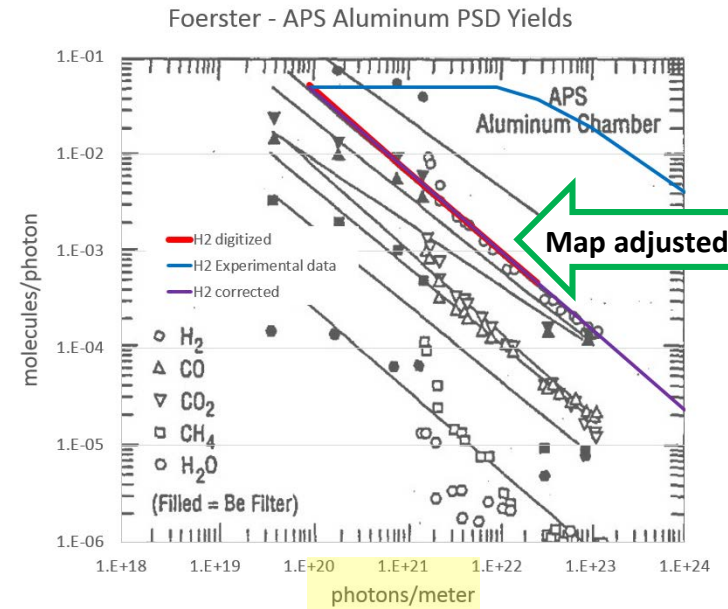

SynRad to MolFlow translation maps

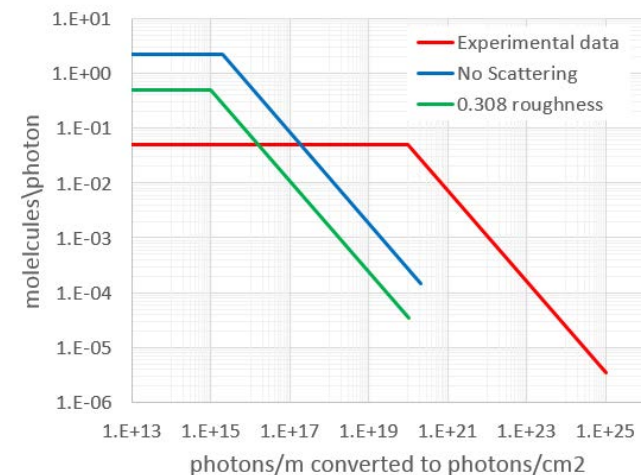

Measurements reproduced in MolFlow+ (top) and adjusted conversion maps (bottom)



# Modelling the pumping system in MolFlow+

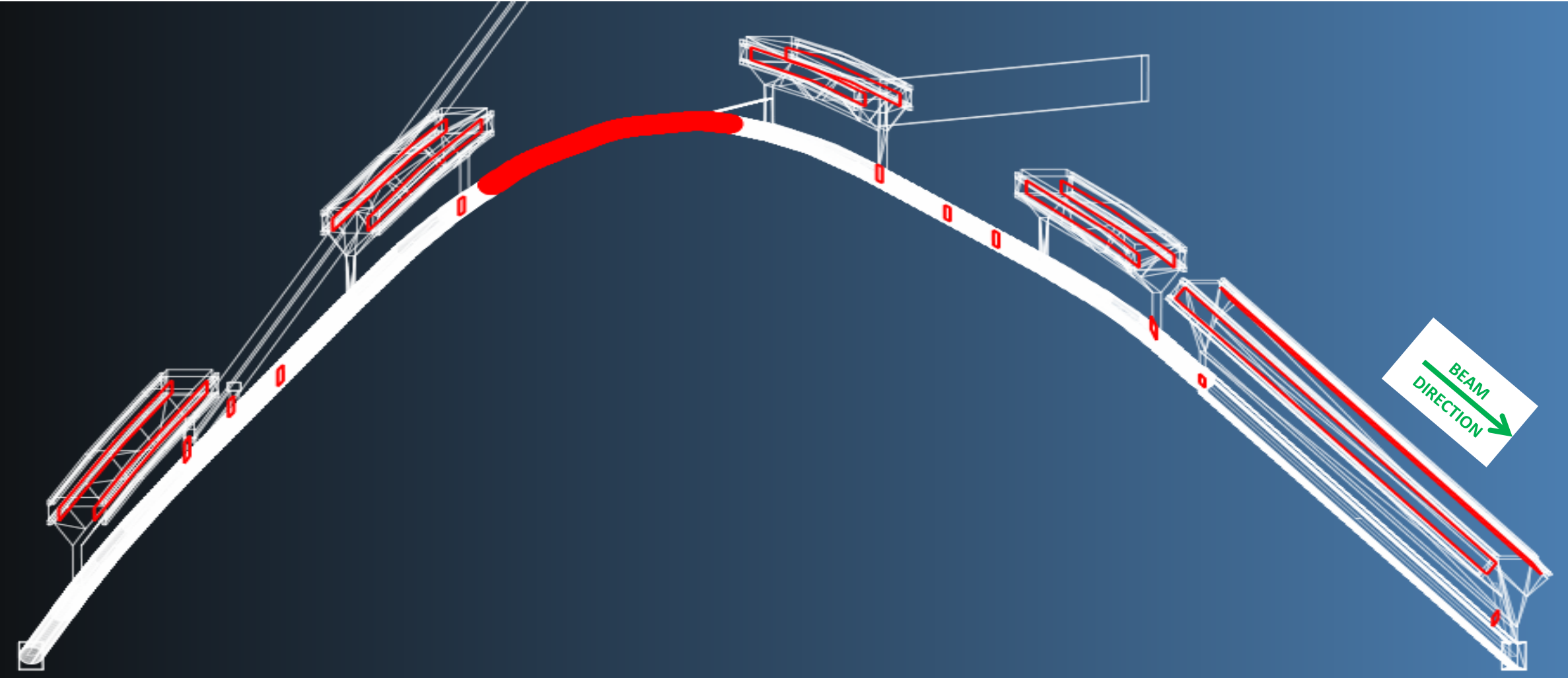

Pumping surfaces highlighted in **red**  
including ion pump ports and NEG strip antechambers

# MolFlow+ pressures

- Pressures computed for 4 gas species: H<sub>2</sub>, CO<sub>2</sub>, CO, CH<sub>4</sub> Methane (CH4) pressure profile has unique shape due to no distributed pumping
- Remaining gases have similar pumping assumptions and pressure profiles

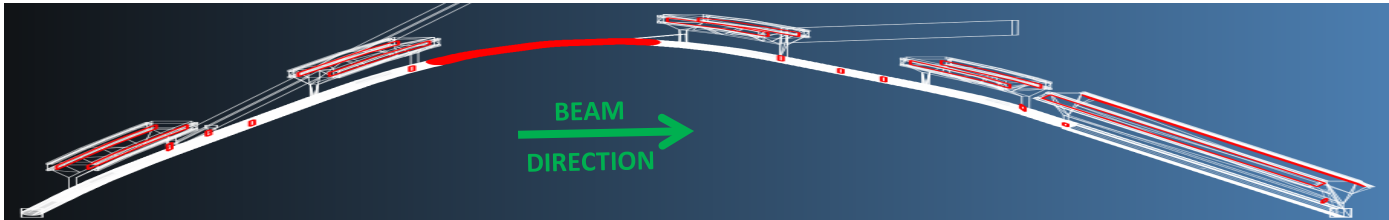
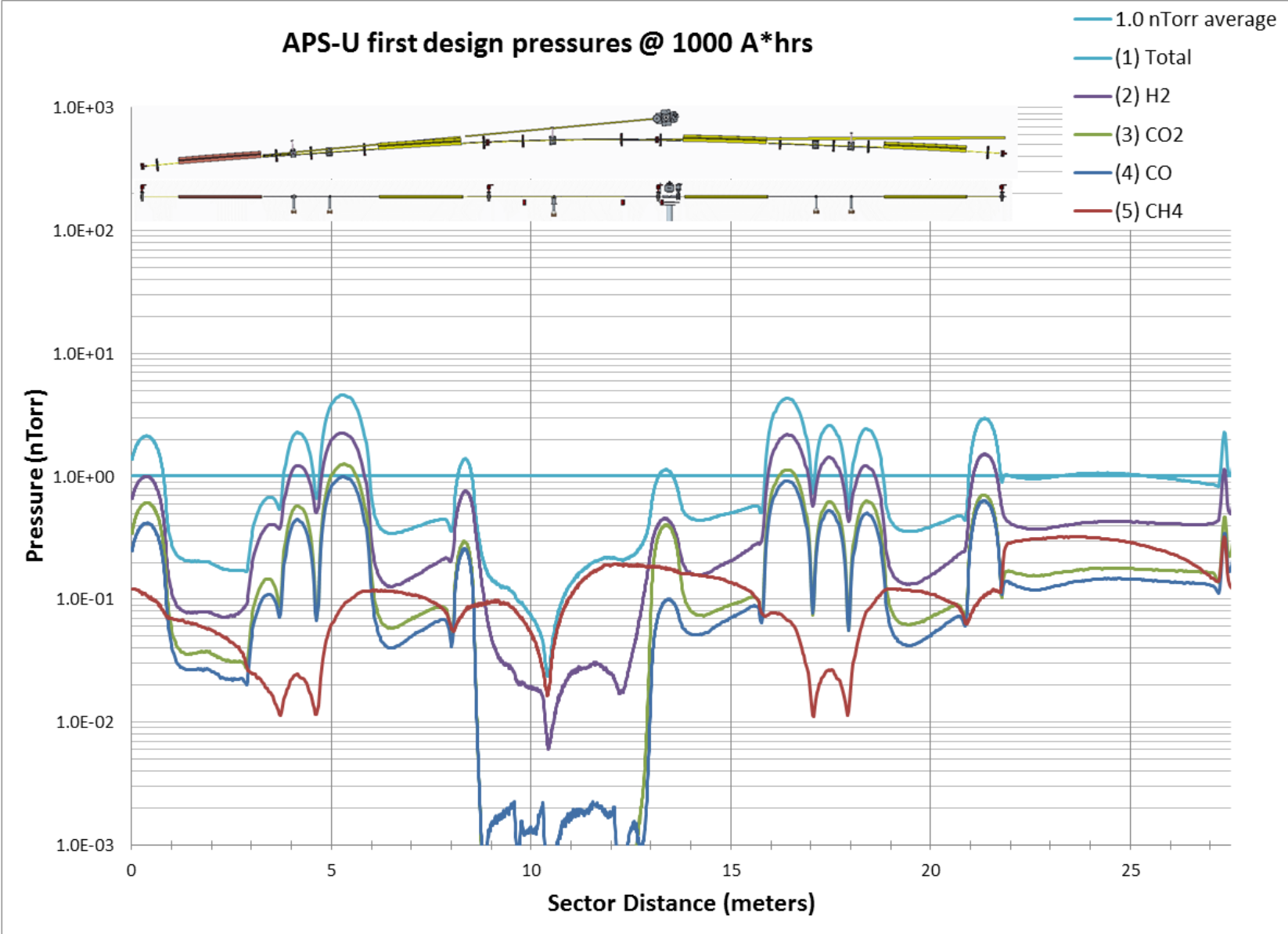

# MolFlow+ pressures, cont'd

- Total pressure profiles reveals that average is defined by pressure bumps occurring in chambers without distributed pumping
- Bumps most notable in non-coated multiplet sections which only have isolated pumps

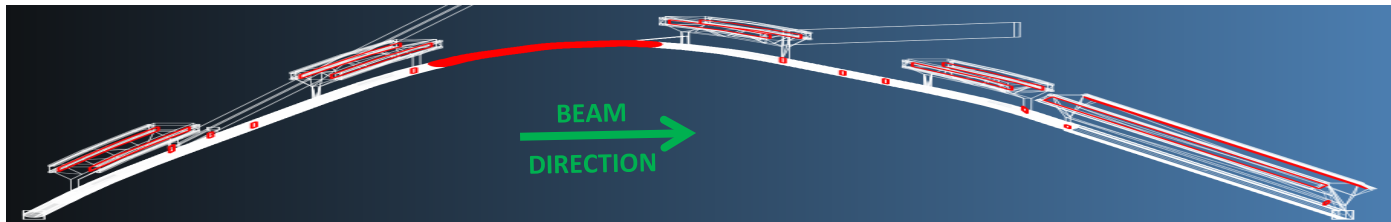
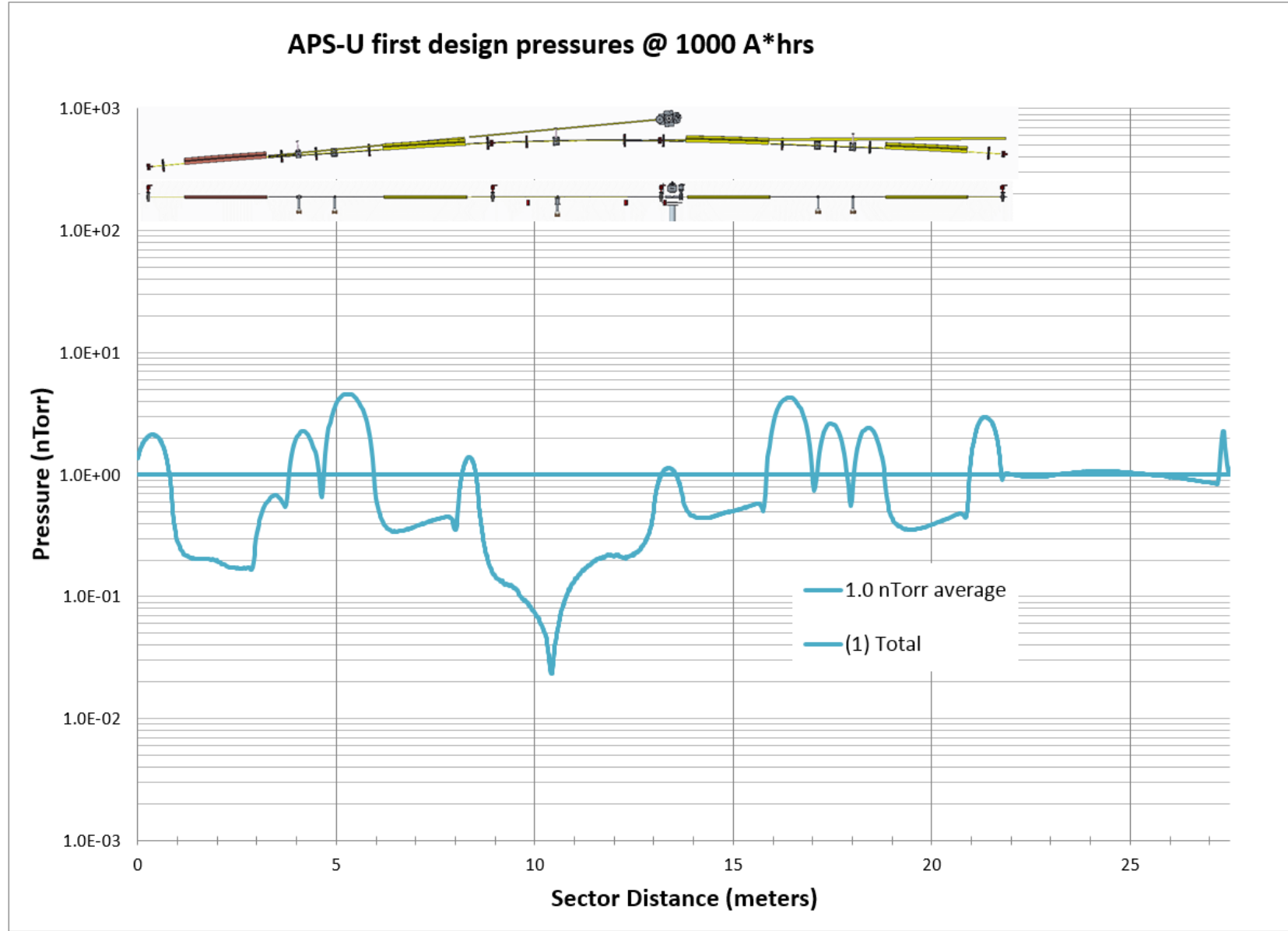

# System conditioning

- Pressures decrease in time as surfaces are conditioned
- 2 nTorr goal reached @ **437 A\*hrs.**
- \*\*note: previous simulations have shown logarithmic cleanup extends past 2 points. Working on increasing points with updated clean up curves...

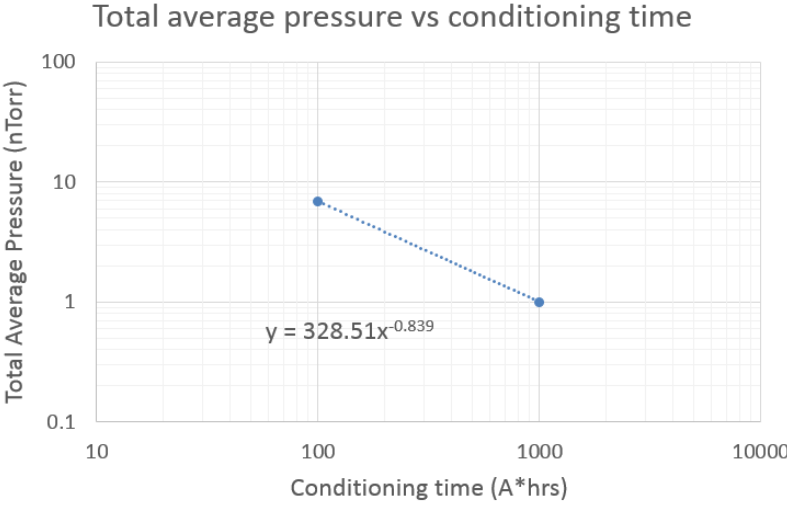

12/14/2015

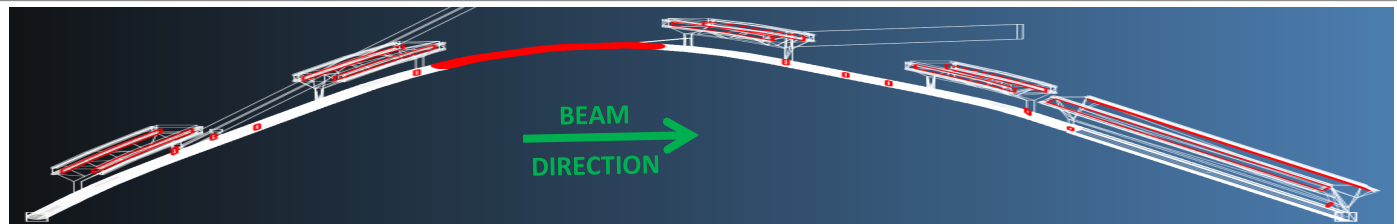
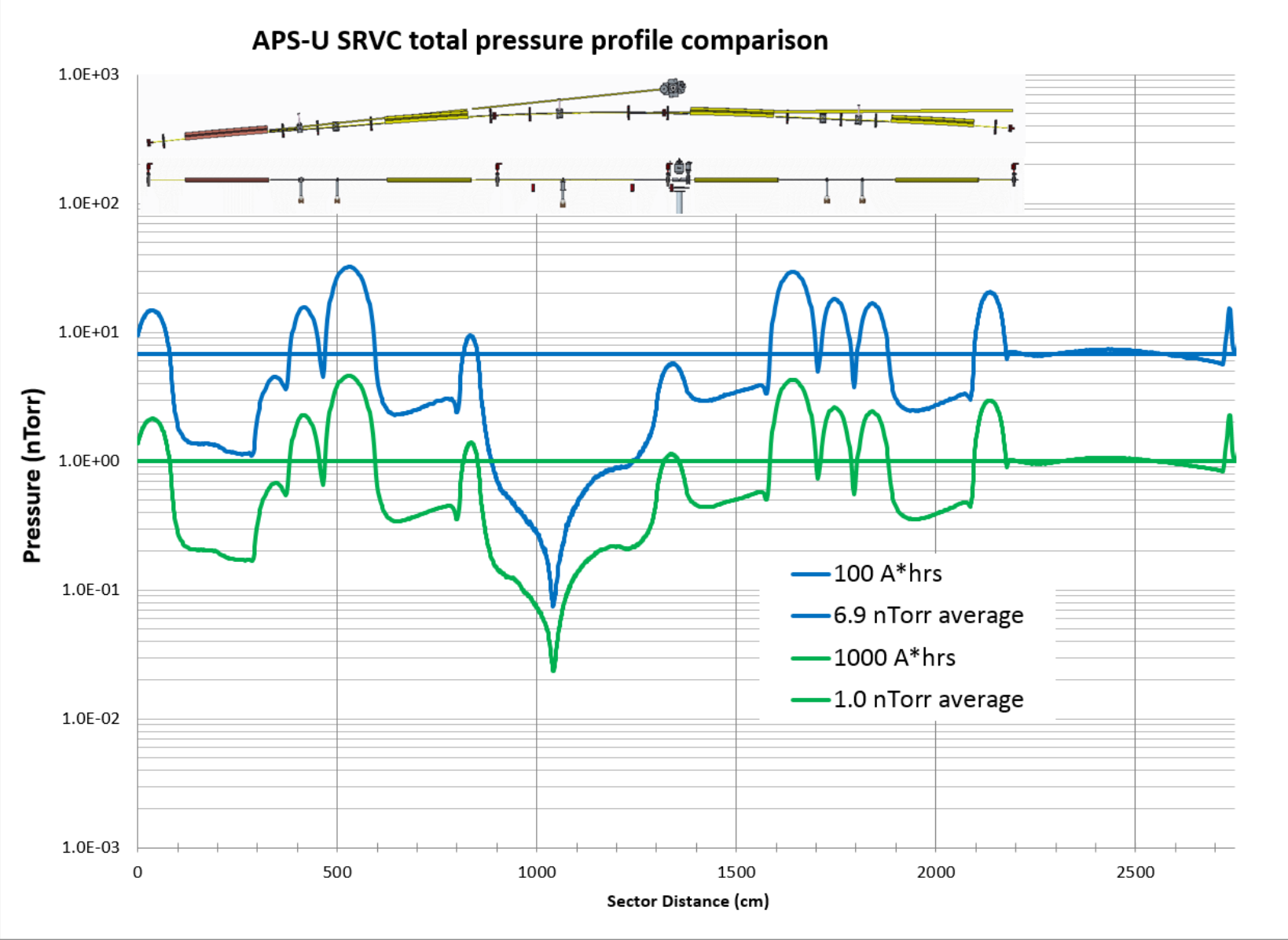

# Scattering study

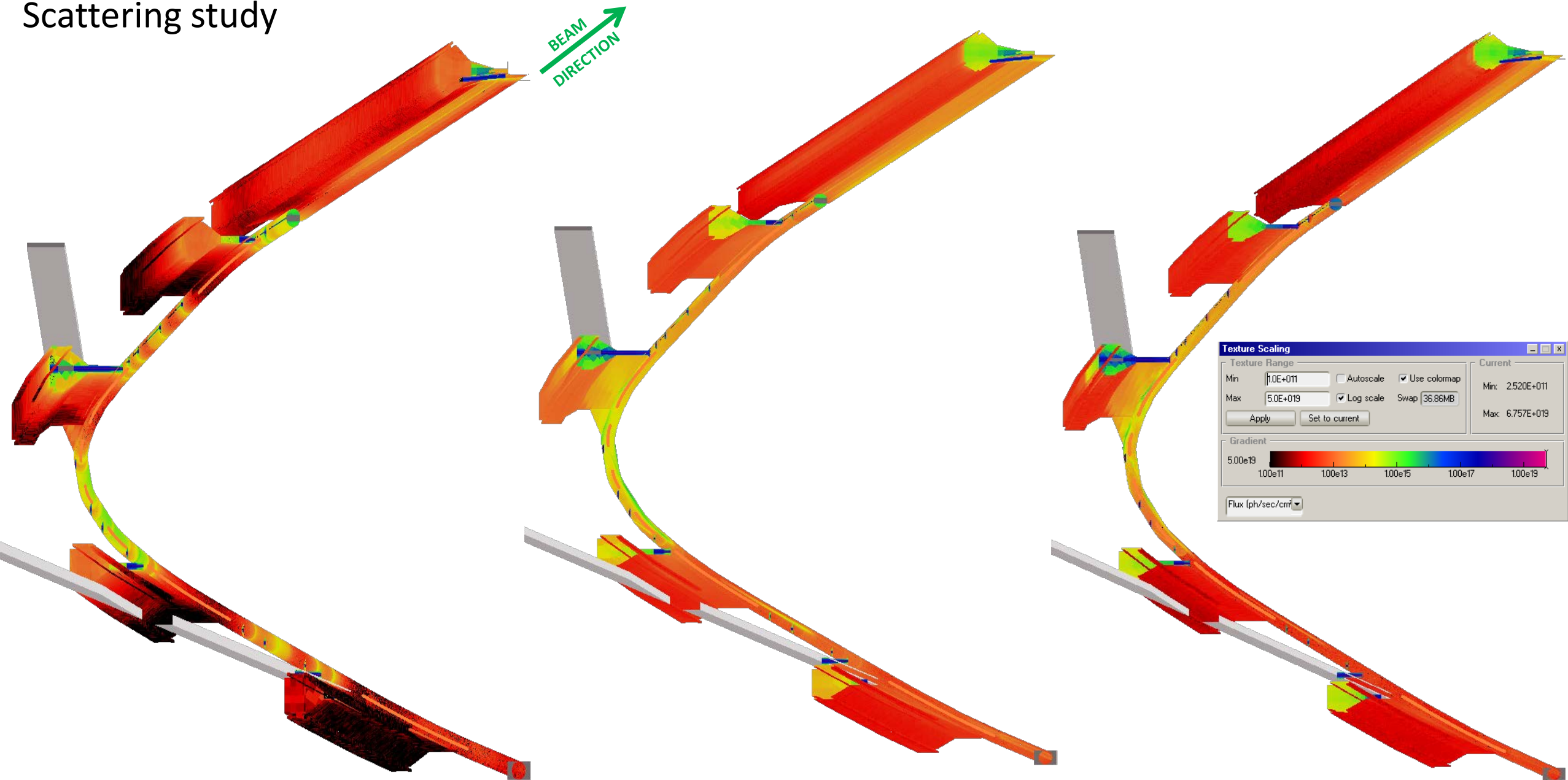

**Texture Scaling**

Texture Range		Autoscale <input type="checkbox"/>		Use colormap <input checked="" type="checkbox"/>		Current	
Min	1.0E+011			Swap 36.86MB		Min: 2.520E+011	
Max	5.0E+019	Log scale <input checked="" type="checkbox"/>				Max: 6.757E+019	
Apply		Set to current					

Gradient

5.00e19 1.00e11 1.00e13 1.00e15 1.00e17 1.00e19

Flux [ph/sec/cm<sup>2</sup>]

12/14/2015

**(1)** Newer SynRad  
Roughness 0.308

**(2)** Newer SynRad  
Roughness 0.01

**(3)** Older SynRad  
Roughness 0.001

# Scattering study

- Pressures with scattering increased by over an order of magnitude
- Choice of roughness leads to small variations in pressure, similar to KEKB findings
- \*\*notes: scattering study performed with overly conservative translation maps
  - Magnitudes too high, but pressure shapes equal!

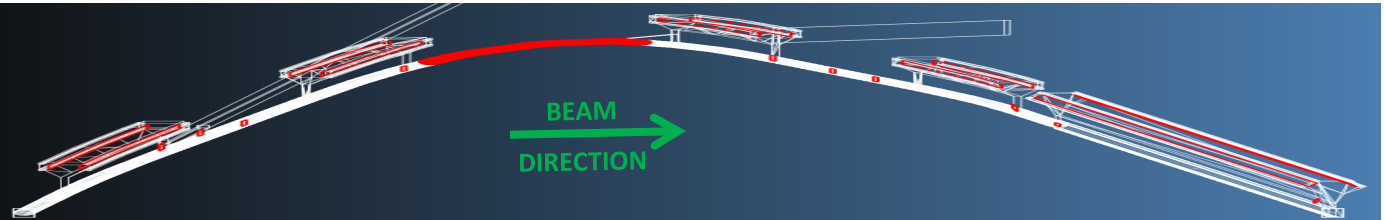
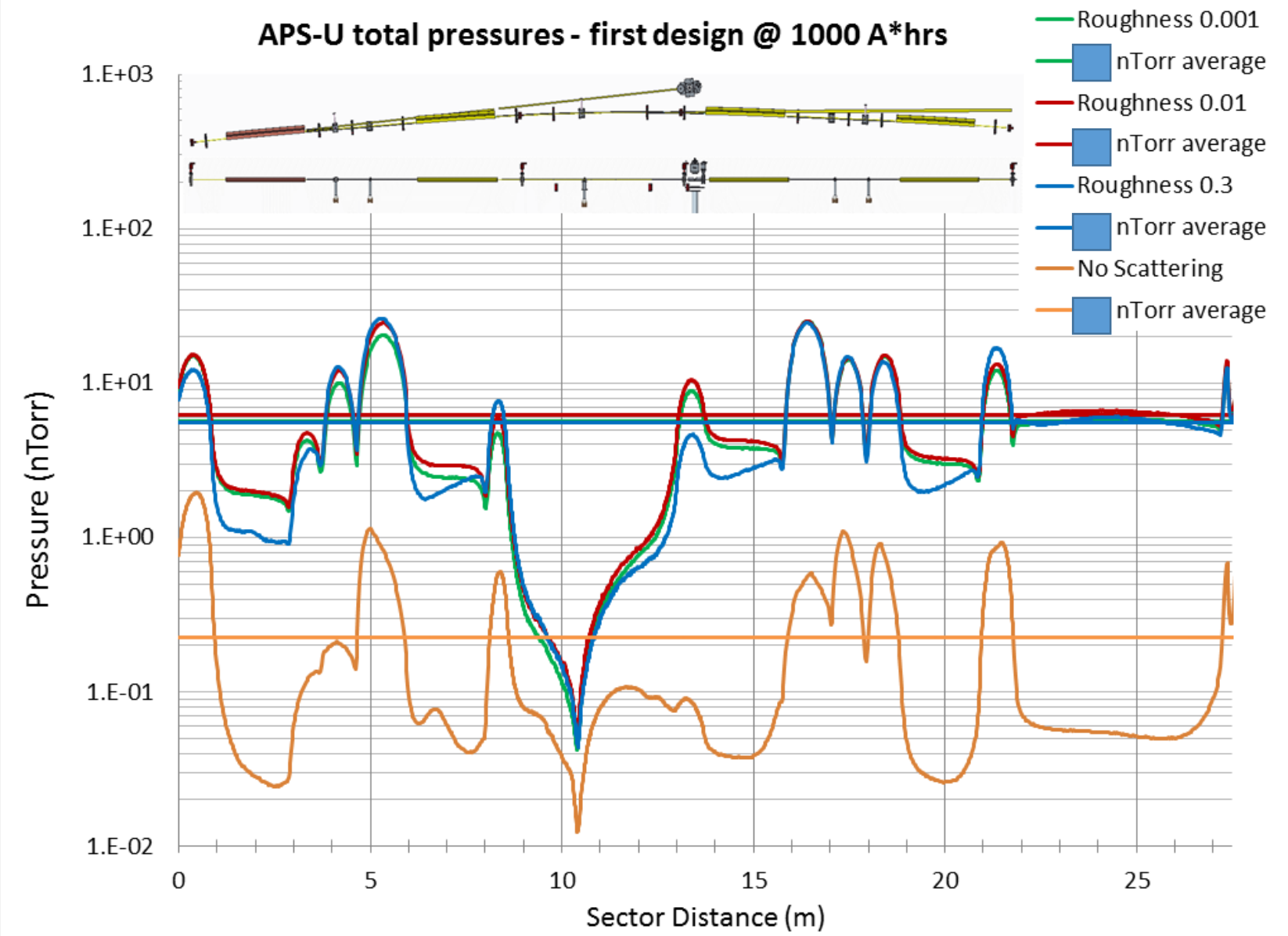

# No scattering vs 1D simulations

- Early work to compare MolFlow+ coupled simulations w/o scattering to 1D vacuum program VacCalc
- As equal inputs as possible
  - Equal pumping assumptions
  - VacCalc PSD gas loads interpreted from ray trace
  - Conductances hard coded into VacCalc
- Both programs predict much more generous cleanup time  $\sim 100 \text{ A*hrs}$
- VacCalc higher by about a factor of 2
  - Not considered bad relative to typical vacuum margins but we will continue to explore and understand differences...

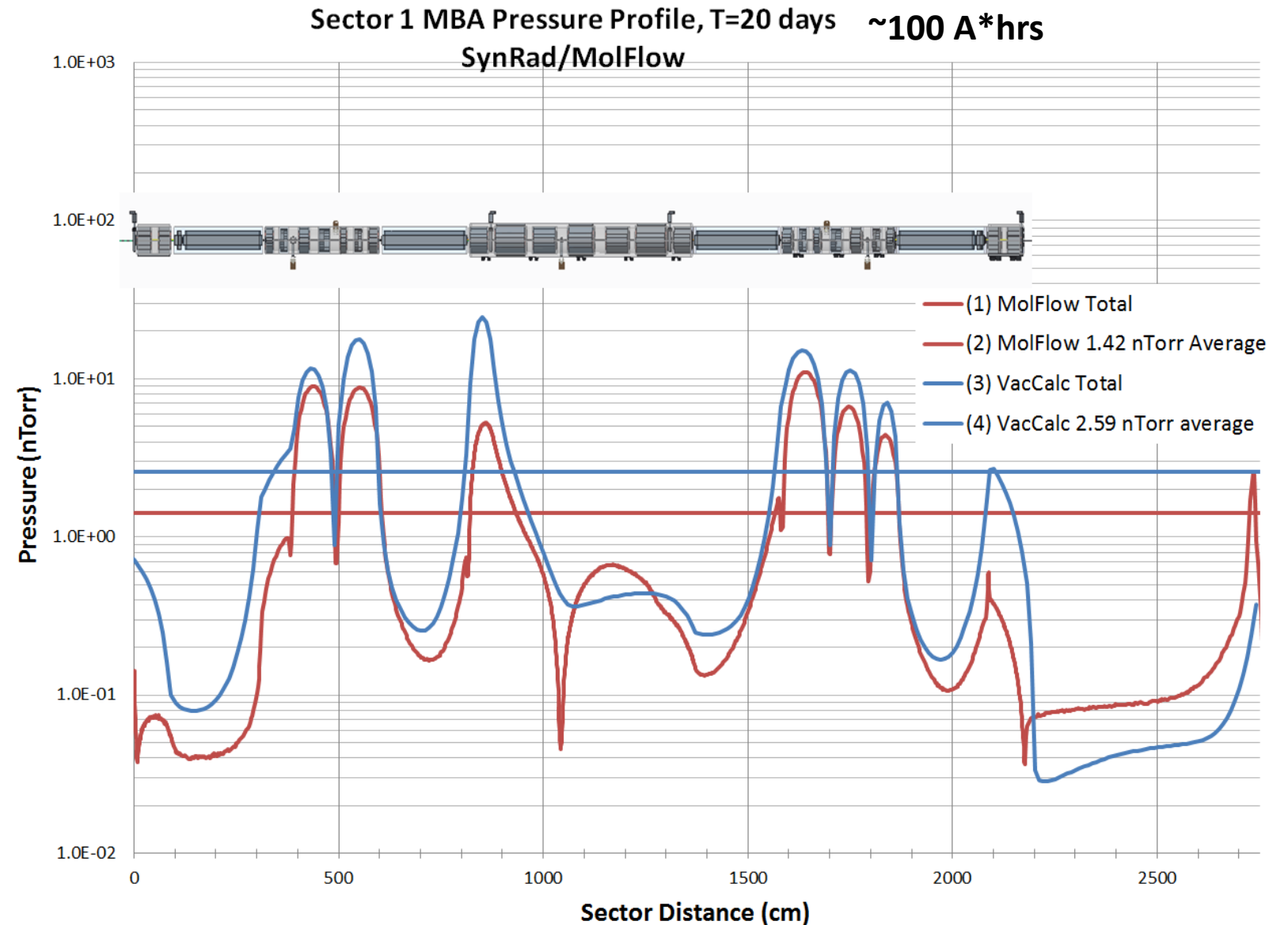

1D VacCalc pressures compared to SynRad/MolFlow+  
coupled w/o scattering @ 100 A\*hrs

# Beam lifetimes

- APS physicist Michael Borland submitted a recent IPAC paper which uses our MolFlow+ pressures to determine gas specific lifetime effects and estimate beam lifetimes
  - ‘Simulations of gas scattering lifetime using position and species dependent pressure and aperture profiles’ M. Borland IPAC 2015
- Paper analyzes older data set with 2 nTorr average pressure and computes 26 hour lifetimes
  - Latest results indicate 30 hours gas scattering lifetime goal to be reached in less than 1000 A\*hrs conditioning
- Finds that computing lifetimes with variable pressure curves is more conservative than with average uniform pressure
- Results confirm that CO<sub>2</sub>, CO, and CH<sub>4</sub> most significant towards beam lifetimes

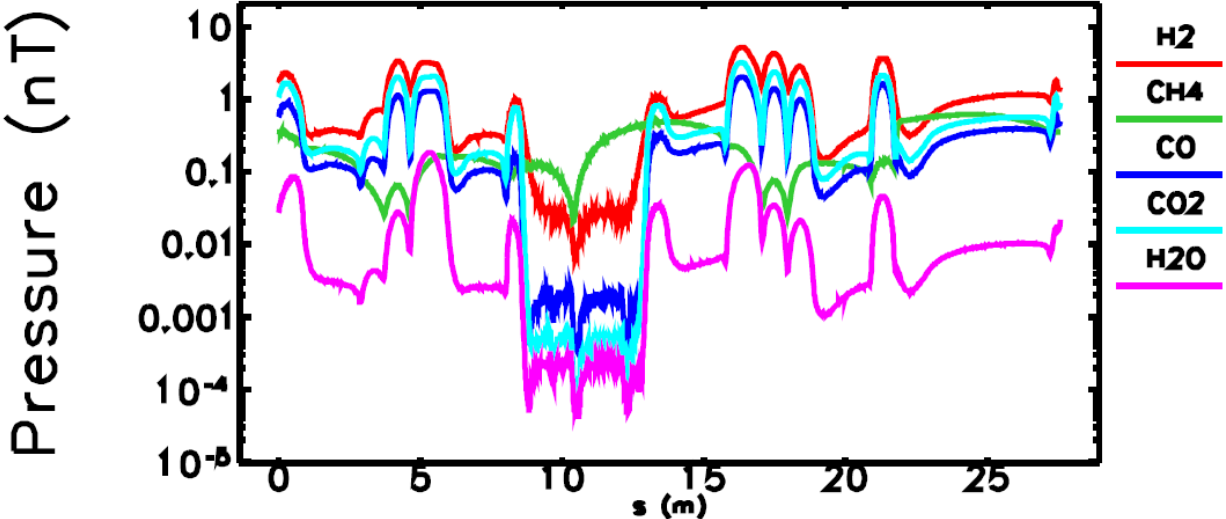

Plot of MolFlow+ pressures  
Dominated by H<sub>2</sub>, CH<sub>4</sub>

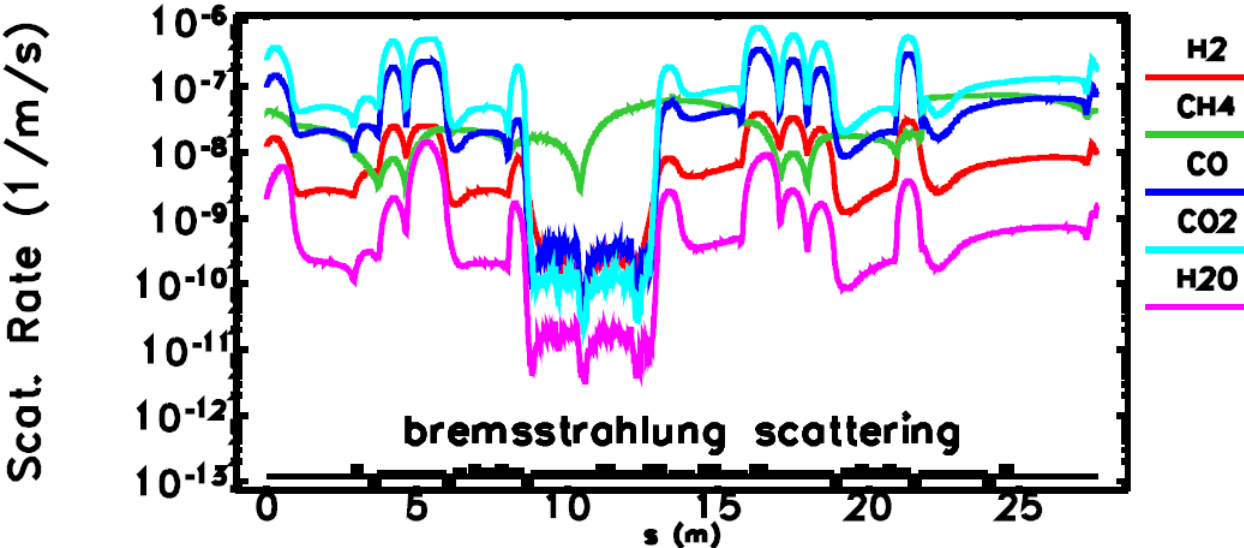

Plot of gas scattering lifetime effects  
Dominated by CO<sub>2</sub>, CO, CH<sub>4</sub>



# Conclusions

## APS-Upgrade

- Coupled simulations more conservative with photon scattering
  - Compares well to 1-D w/o scattering
- Simulations with scattering and conservative PSD map indicate system will exceed design goals of 2 nTorr @ 1000 A\*hrs
- Accuracy of SynRad's photon scattering is not benchmarked
  - Results indicate roughness variations have relatively small influence on pressures
- Michael Borland's work helps better understand vacuum consequences

## Continued work

- Document sensitivity of program inputs such as roughness, PSD mapping assumptions to establish error bars
- Modeling active APS PAR vacuum system
- Test beam-off pressures of sector mockup in 2016
- Hope to perform PSD measurements on our own APS-U chamber designs to build confidence in performance

