

DEVELOPMENT OF THE NEXT GENERATION X- RAY BEAM POSITION MONITOR SYSTEM FOR THE APS UPGRADE



Bingxin Yang for the APS NG-XBPM Team
Physicist, ASD-DIA
Argonne National Laboratory

ASD Seminar
October 19, 2016

Outline

- Introduction
- Physics of the white undulator XBPM
- APS GRID-XBPM: engineering design and performance
- Summary

Intro: Why do we need front end XBPM?

[Short/Political answer] Provide direct information for quality control of light sources' final product, photon beams, mostly about its stability.

[Long/Technical answer] Stable beam in the electric center of RFBPMs does not always produce stable x-ray beam. The spoiling factors include undulator steering, mechanical motion of the RFBPM and accelerator chamber, bunch pattern dependence of RFBPM offset, to name a few.

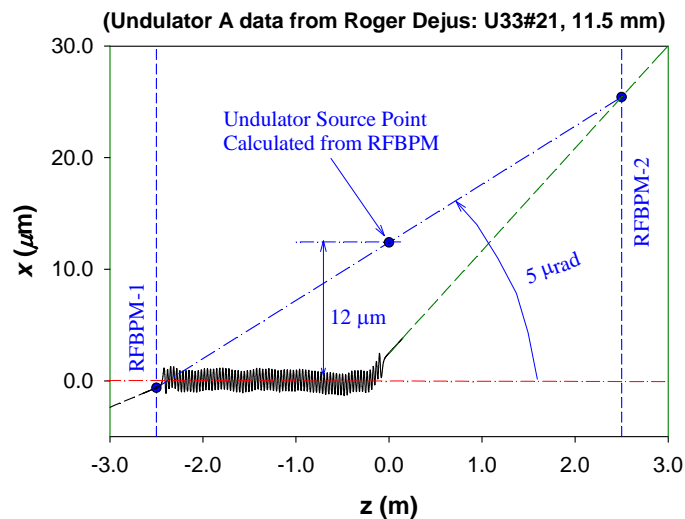

Electron trajectory in an undulator

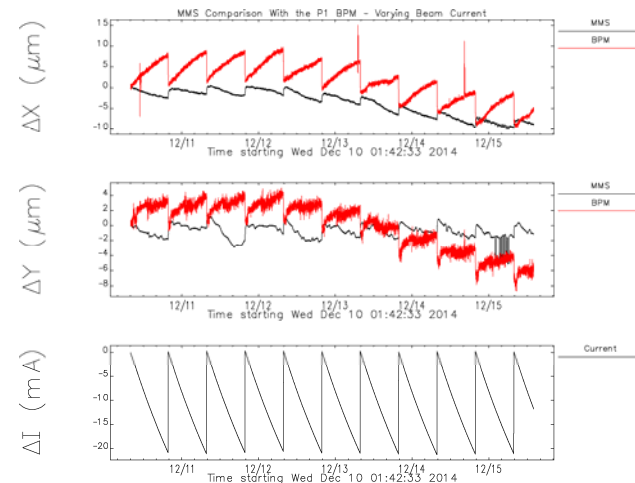

Chamber RFBPM motion with current.

XBPM is an important tool for to beam angle stability.

Intro: What's special about FE XBPMs

Undulator front end XBPM present unique challenges:

- Operates with a strong bend magnet background.
- Cannot touch the user beam in the central cone. But photon beams have to be intercepted to generate signals.
- Must survive direct hit of the full-power undulator beam.

[Resolution requirements]

- Spatial resolution of 1 – 2 μm is usually sufficient.

For an ideal undulator source (7GeV/U33/N70/ λ 1Å/Emittance=0)

$$FWHM(\lambda = 1\text{\AA}) \sim 1.6\sqrt{\lambda / L_u} \sim 10(\mu\text{rad})$$

Opening angle of the x-ray beam is 200 μm FWHM / 40 mm- σ at 20 m,

X-ray beam position tolerance (@20m) = 8 μm rms (10% σ)

X-ray beam angle tolerance \sim 0.4 μrad .

Accuracy/stability at all gaps is more important than sub-micron resolution!

APS-U Beam Stability Goals

APS Upgrade beam stability goals (CDR)

	Plane	RMS AC motion (0.01 – 1000 Hz)		RMS long term drift (7 days)	
APS-Upgrade goals	Horizontal	1.7 μm	0.25 μrad	1.0 μm	0.6 μrad
	Vertical	0.4 μm	0.17 μrad	1.0 μm	0.5 μrad
Currently worst cases in operations	Horizontal	6.0 μm	1.7 μrad	10 μm	2.8 μrad
	Vertical	3 μm	0.85 μrad	10 μm	2.8 μrad

XBPM tolerance specifications ($Z = 20$ m)

	Plane	RMS AC motion (0.01 – 1000 Hz)		RMS long term drift (7 days)	
X-ray beam Position tolerance	Horizontal	5.3 μm		12.0 μm	
	Vertical	3.4 μm		10.0 μm	
XBPM error budget	Horizontal	3.7 μm		8.5 μm	
	Vertical	2.4 μm		7.1 μm	

Photoemission XBPM not good: gap dependence 100's μm , after correction 10's μm !

The Key is to Minimize XBPM Systematic Error!!

Intro: What material can we use for FE XBPM

Requirement for front end XBPM target materials:

Anything that can be held stable in the undulator beam!

Intense undulator radiation produces many secondary products, for example:

1. Photoemission/secondary electrons (many 3rd sources use)
2. Charge carriers in solids (electrons and holes in ion chamber)
3. X-ray fluorescence photons (XRF from absorbers)
4. Scattered x-ray photons (Compton from low-Z targets)
5. Photo ions/electrons from residual gases

No. 2 is actively developed by several light sources. Developments at the APS centered on Nos. 3 and 4, since reliable XRF/Compton targets can be made to last (by conservative engineering standards).

Real engineering challenging issue is to stabilize target in the beam!

Intro: The APS next generation FE XBPM

APS's two-part strategy for x-ray beam controls / stabilization:

- Decker distortion → stabilize / reduce / soften BM background
- Next generation XBPM → Hard x-ray beam position monitor, insensitive to low-energy x-rays

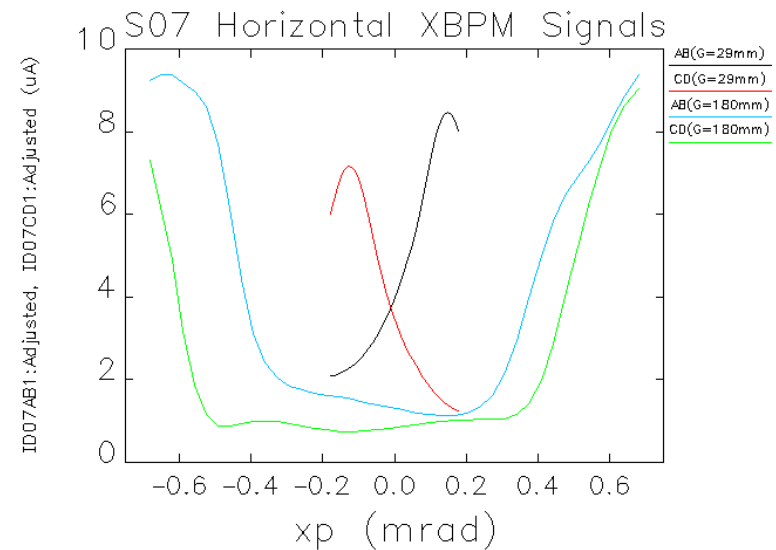
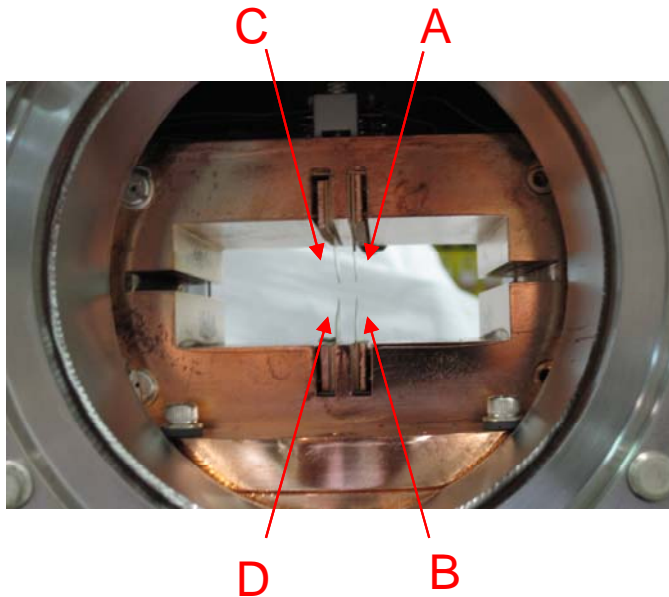
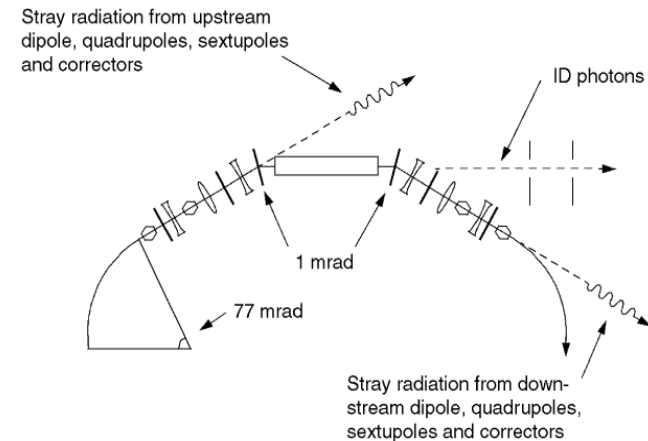

Photoemission XBPMs do not meet the requirement due to BM background.

XBPM physics: perspective from simulation

[Simulation-guided conceptual design]

- Generate spectra through $\sim 5 \mu\text{rad}$ ($100\mu\text{m}@20\text{m}$) square pinholes: XOP/urgent/xus, $\{\lambda, F(\lambda); x, y\}$
- Calculate intensity of Cu-K x-ray fluorescence using the XBPM geometry, with self absorption: xraylib database, $\{\lambda, F(\lambda)\} \rightarrow I$
- Scan the pinhole position to generate response map $\{I; x, y\}$
- Calculate signal profiles based on XBPM absorber geometry (x, I)
- Define and tweak target and detector geometry to optimize the design

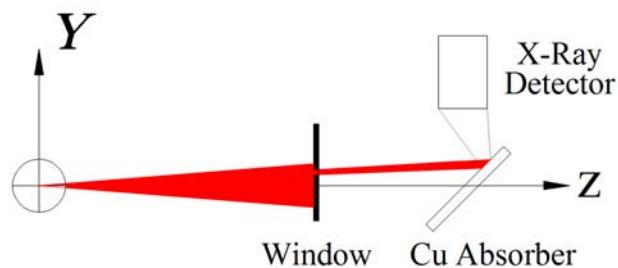

GRID-XBPM geometry

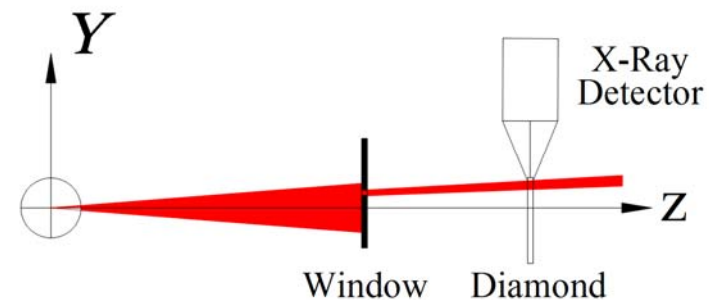

Compton XBPM geometry

Demonstration: APS HHL GRID-XBPM design procedure

XBPM physics: response maps

Response maps depend strongly on the secondary product collected and detection geometry (7GeV/U33/N70x2/K2.8).

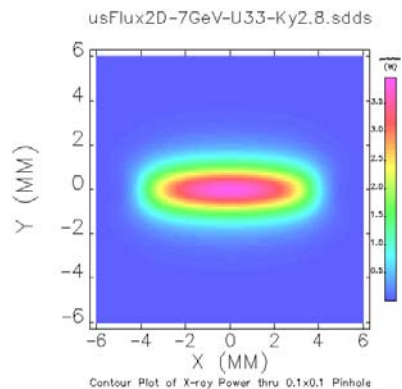

Total Power

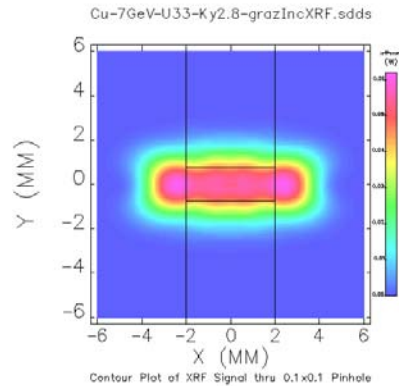

Copper K-edge XRF

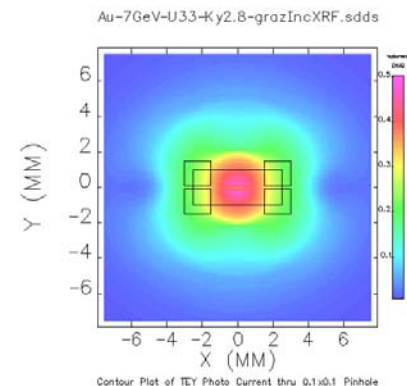

Photoemission (Au, TEY)

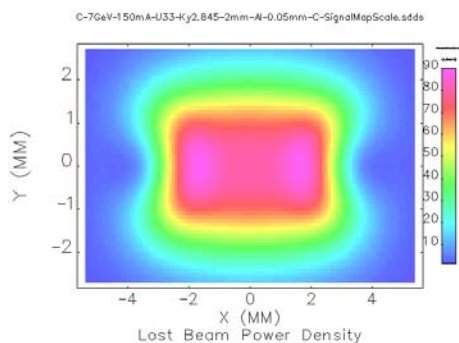

Diamond: Absorbed Power

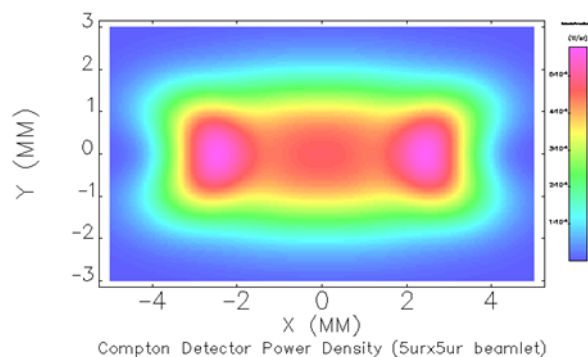

Scattered Power

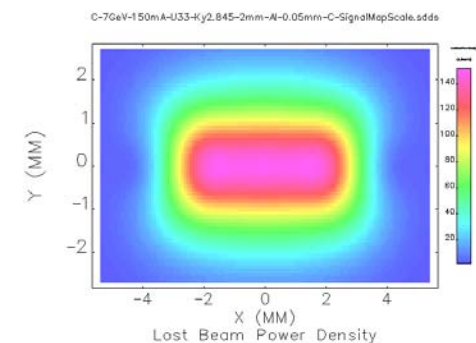

Lost Power

Physics: signal profiles and “blade” design

Difficulties in mounting diamond blades in HHL FE → Only candidate is GRID-XBPM using XRF from GlidCop absorber. The FE uses vertical surfaces to absorb beam power up to 22 kW. Signal profiles are simply vertical integration of response maps.

[First observation] The old design with four blades cannot be used for XRF-based XBPM: Negative signal slopes for some gaps!

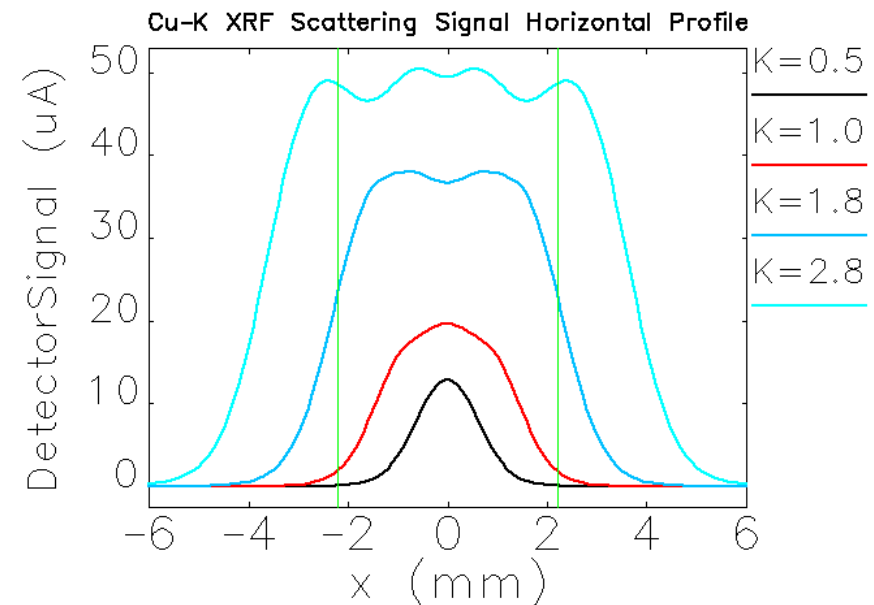
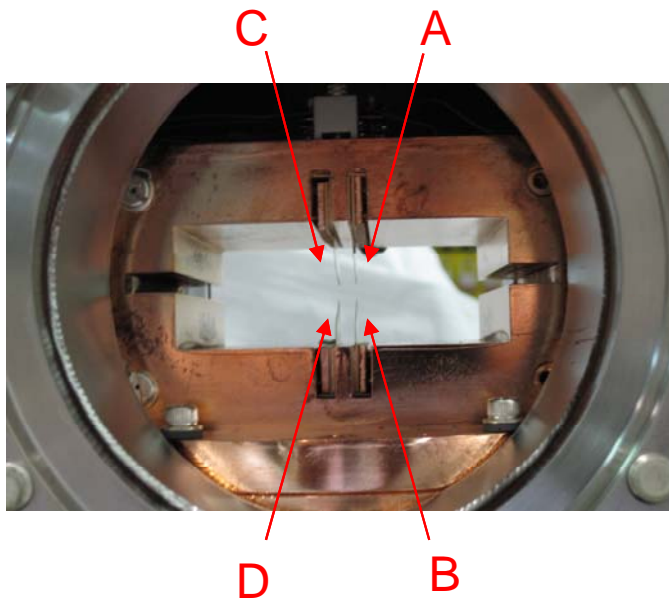

Quad-blade design does not work for XRF-based hard x-ray BPM!

Physics: verify horizontal signal profiles

Due to their importance to the XBPM design, we experimentally measured the horizontal profiles of the Cu XRF signals with U30. Most features of the profile shape are shown in the experimental data, except that the triple peak was not fully developed due to the limited K of 2.3 of U30.

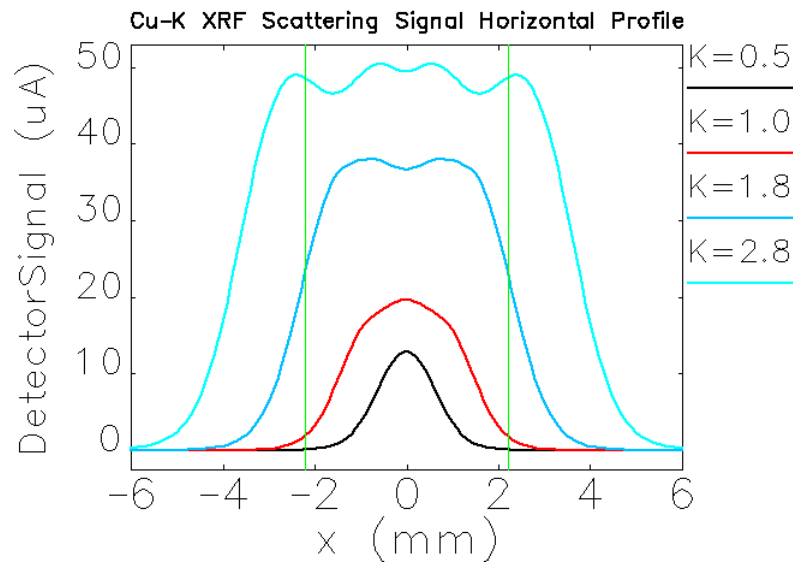

Simulated signal x-profile

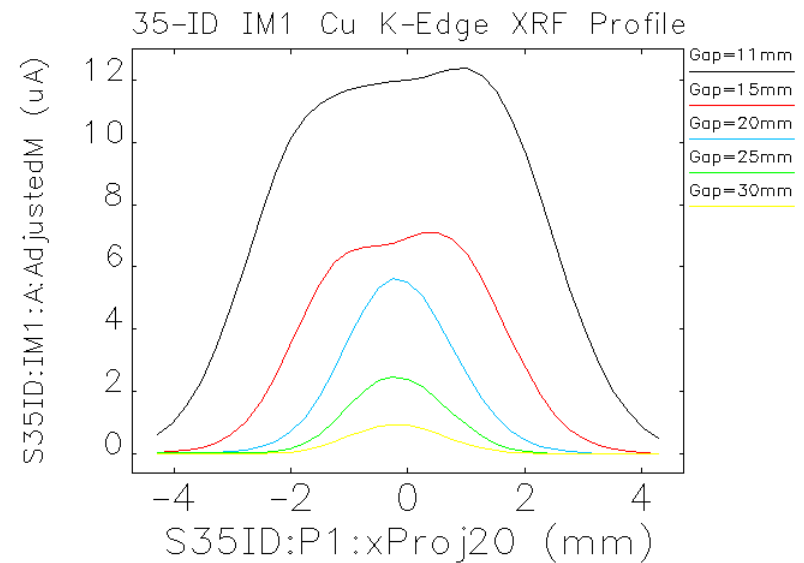

Measured x-profiles of Cu XRF.

These important features have been verified.

Physics: signal profiles and XBPM aperture

Signal profiles determines XBPM's horizontal aperture:

- Entrance aperture includes slopes at max K.
- Smaller exit aperture improves undulator signal to BM background ration at min-K. In this example, undulator signal is $\sim 100\times$ BM background at 1.5 mm.
- Good symmetry for lower offset shift.

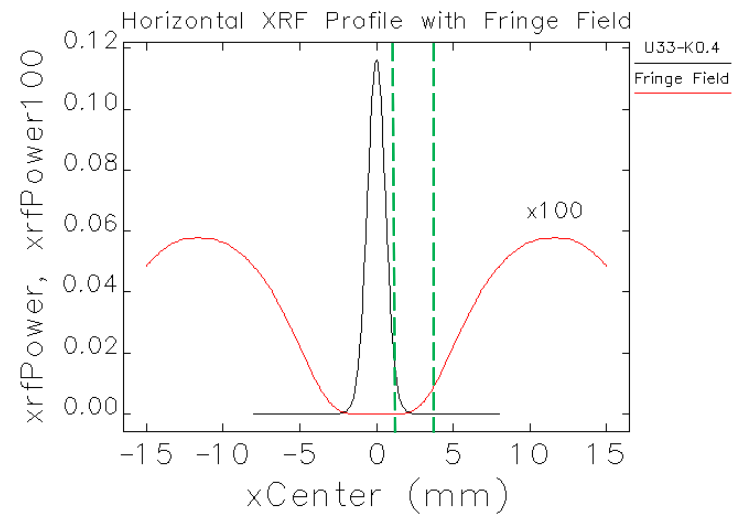
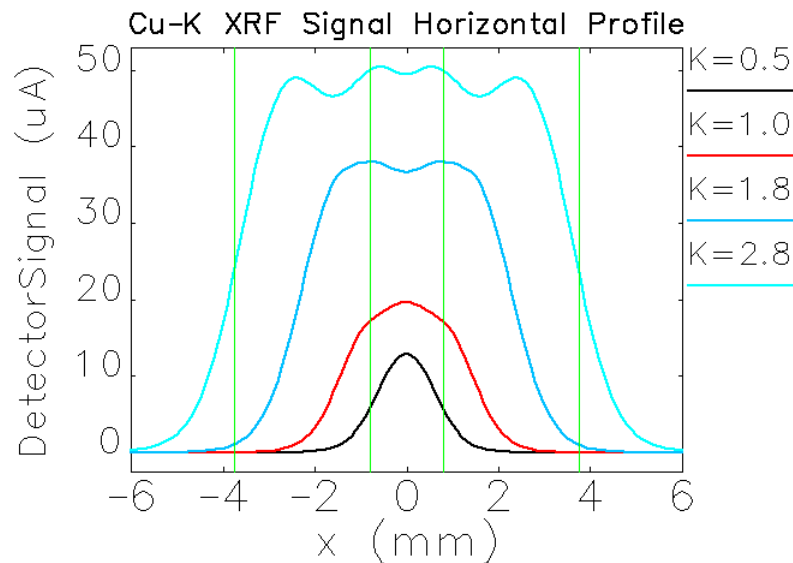
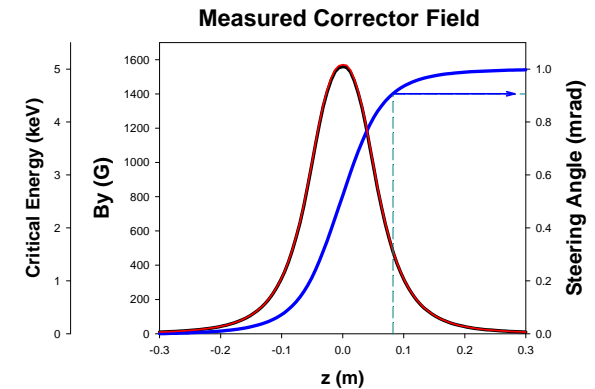

APS HHL-FE XBPM: Small exit aperture results in good Signal/BM ratio

Results from thermal and physics simulations

Input:

- Two inline undulator with maximum power 22 kW
- XBPM located at 20 m from the source

Thermal analyses results:

- Use vertical GlidCop absorber surface for longer beam footprint
- Absorber survives undulator beam with grazing-incidence angle < 1 degrees

X-ray simulation results:

- Quad-blade geometry is useless due to multi-peak signal profiles
- Entrance aperture > 7.5 mm, a little larger allows user steering
- Exit aperture < 2.5 mm, the smaller the better
- Vertical aperture > 5.5 mm, a little larger allows steering
- Horizontal symmetry is important for lower gap-dependent offset

Engineering design: the big picture

A beam stabilization system upgrade is planned for the APS-U. The next generation XBPM is an important part of the system.

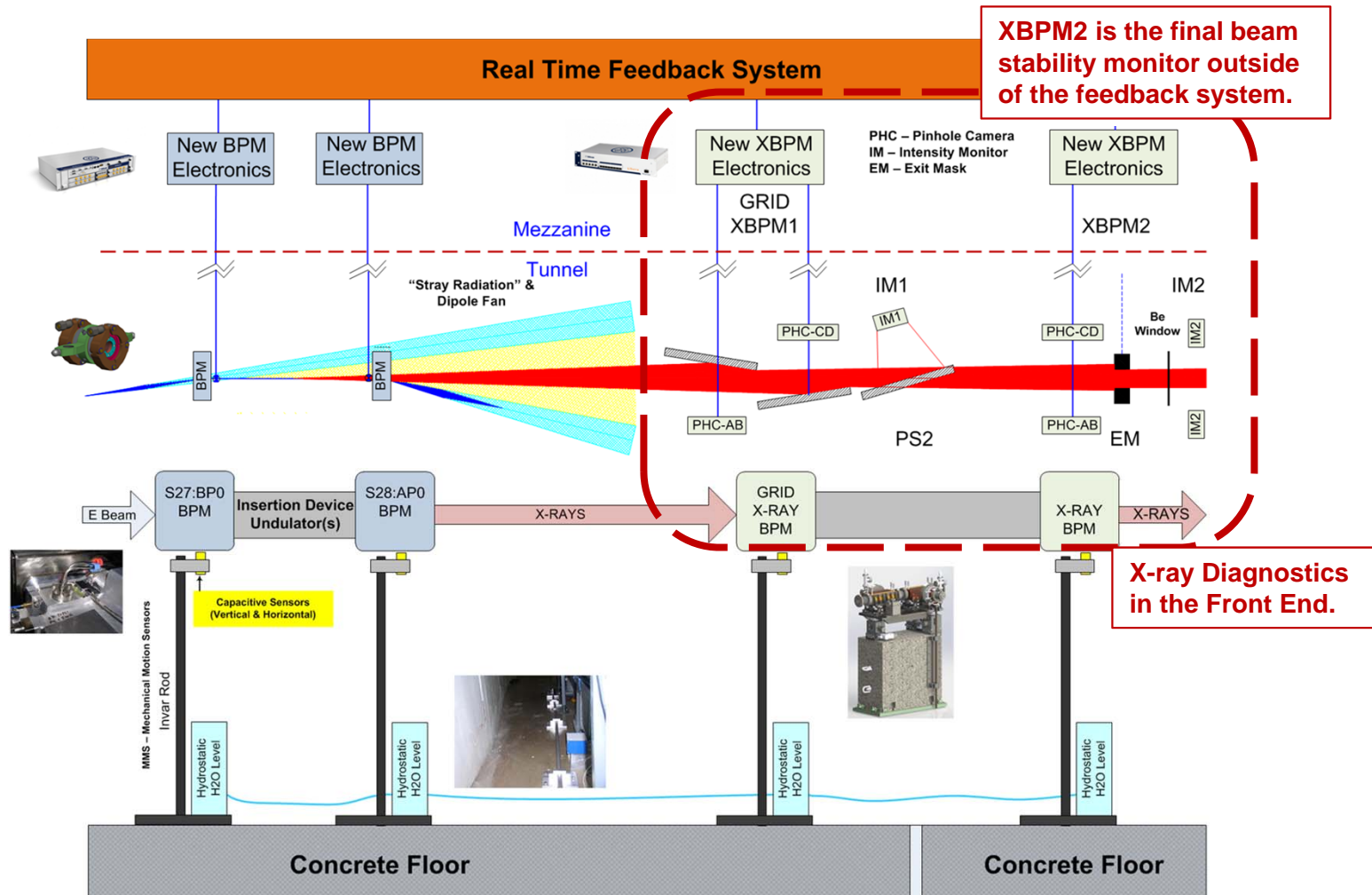

The Next-Generation XBPM System

- The NG-XBPM system includes three major components:
 - GRazing-incidence Insertion Device XBPM (GRID-XBPM) for x-ray beam angle measurements.
 - Second XBPM (XBPM2) using the XRF from the Exit Mask to measure the stability of the beam delivered to the user beamline, not in feedback loop.
 - The first intensity monitor (IM1) using XRF from PS2.
- Status: Two sets installed in May 2014.

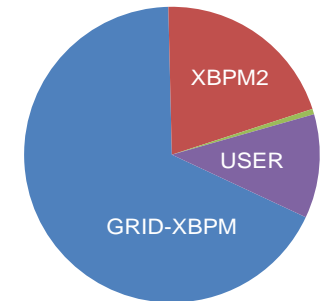

Total Power: 17 kW
 (2xU33, $K = 2.7$, 150 mA)
 Exit Mask: 3mm x 1mm

- GRID-XBPM (11.5 kW)
- ExitMask-XBPM2 (3.5 kW)
- BeWindow-IM2 (0.1 kW)
- User Beamline (1.9 kW)

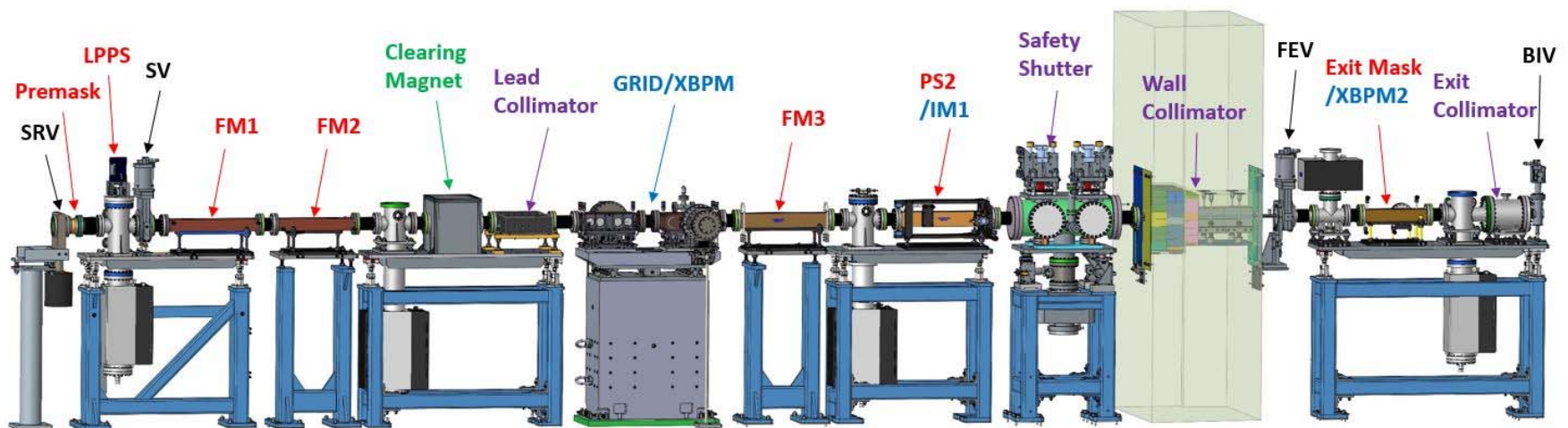

GRID-XBPM design features

Design features of the Grazing Incidence Insertion Device XBPM:

- GlidCop absorber takes most beam power at min gap (14 kW/ 22 kW).
- Horizontal exit aperture set at the installation time.
- Independently supported imaging slits and detector.
- Granite support for mechanical stability.
- Invar-rod supported mechanical motion sensor with hydrostatic level.

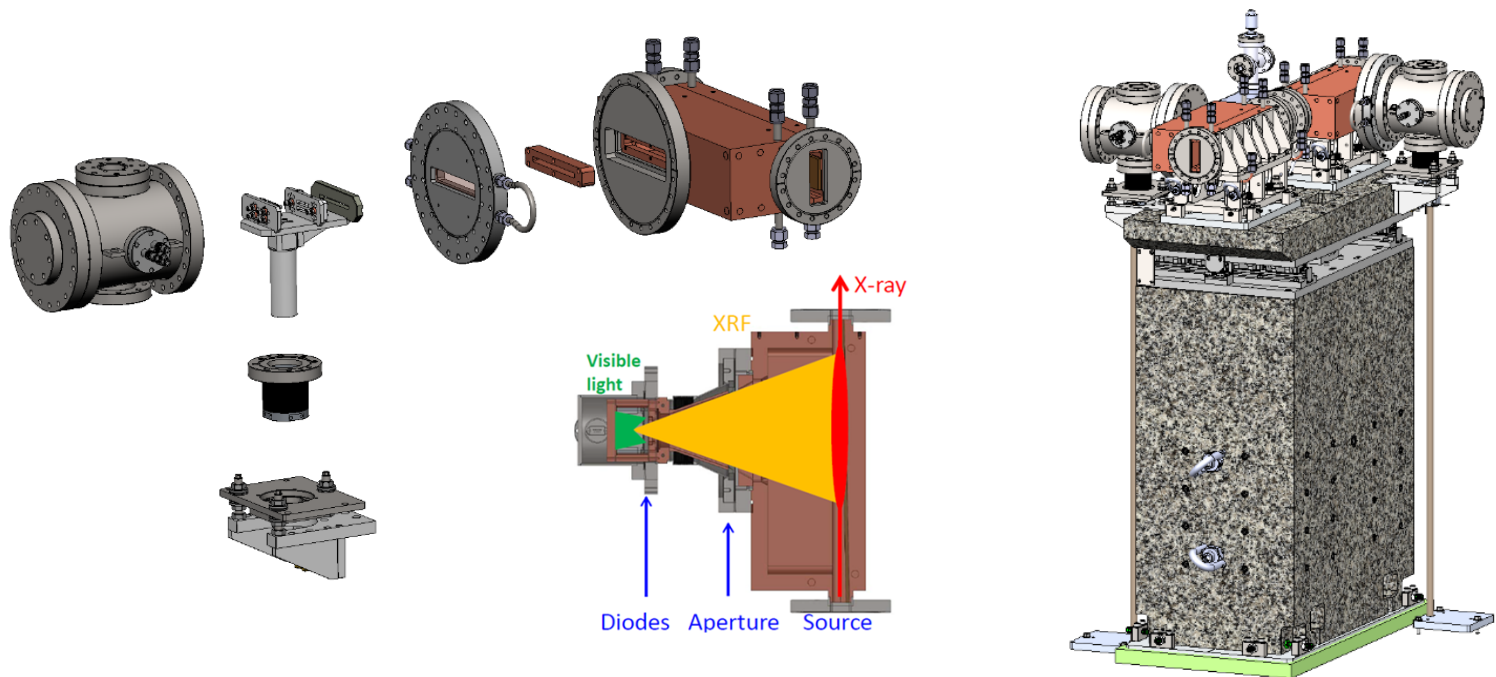

GRID-XBPM: vertical plane readout optics

Pinhole optics + Two PIN diodes → center-of-mass measurements of the vertical position

$$R(\bar{y}) = -\left(\frac{\Delta}{\Sigma}\right)_y = -\frac{I_+ - I_-}{I_+ + I_-} = \frac{M \int \rho(y) y dy}{a \int \rho(y) dy} = \frac{M}{a} \bar{y}$$

By design, the calibration is independent of the undulator gap.

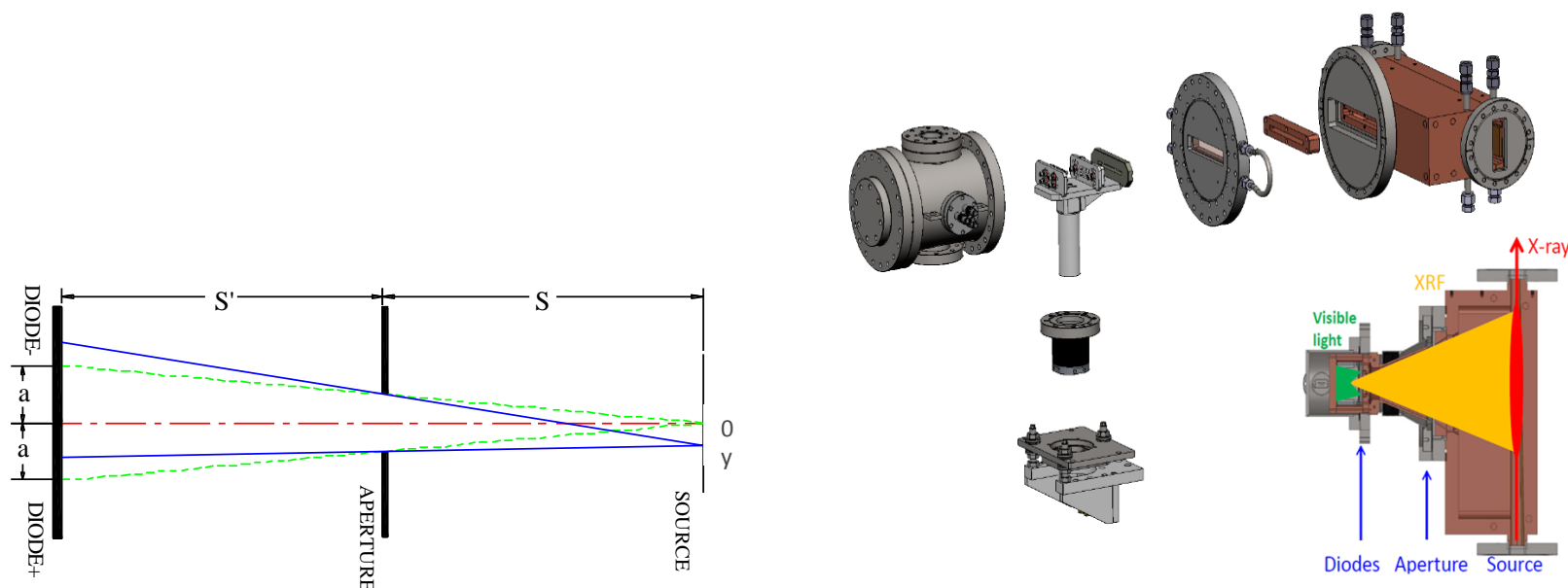

GRID-XBPM: performance in vertical plane

Measurements in the useful gap range (11 – 30 mm) show:

- Vertical calibration stays within $\pm 2\%$ over the gap range
- Offset changes within $180 \mu\text{m}$, representing $9 \mu\text{rad}$ x-ray beam angle change in the gap range, likely due to undulator steering.

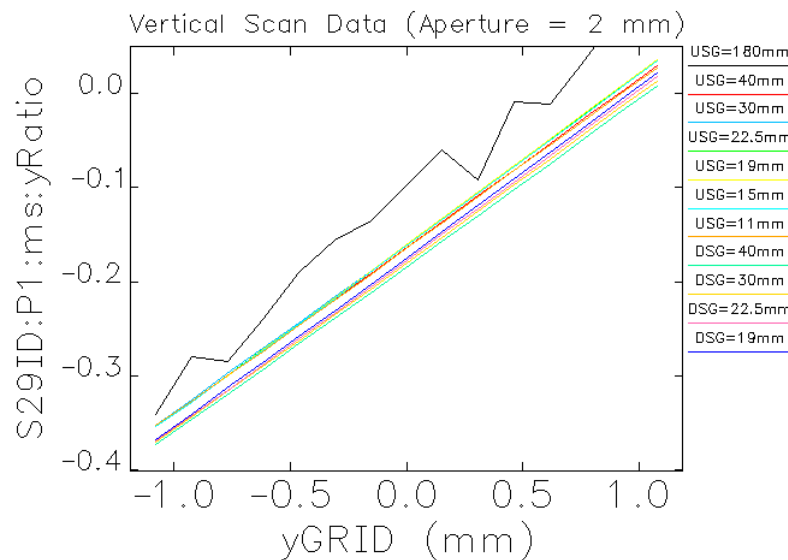

Raw Delta/Sum data

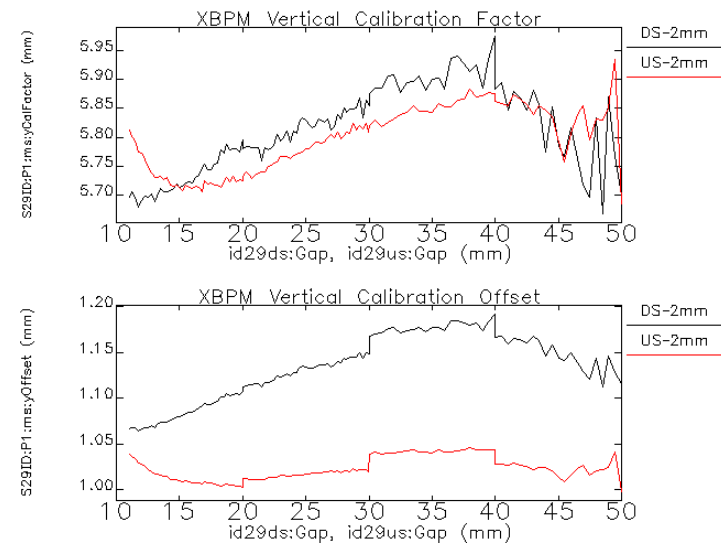

Calibration/Offset vs. gap

GRID-XBPM: performance in horizontal plane

- In the horizontal plane, GRID-XBPM's calibration constants are strongly dependent on the undulator gap.
- An IOC program automatically monitors the undulator gap values, calculates and loads correct calibration constants.
- **Implication: Horizontal XBPM mover is highly desirable!**
- **Implication: Horizontal steering is a problem!**

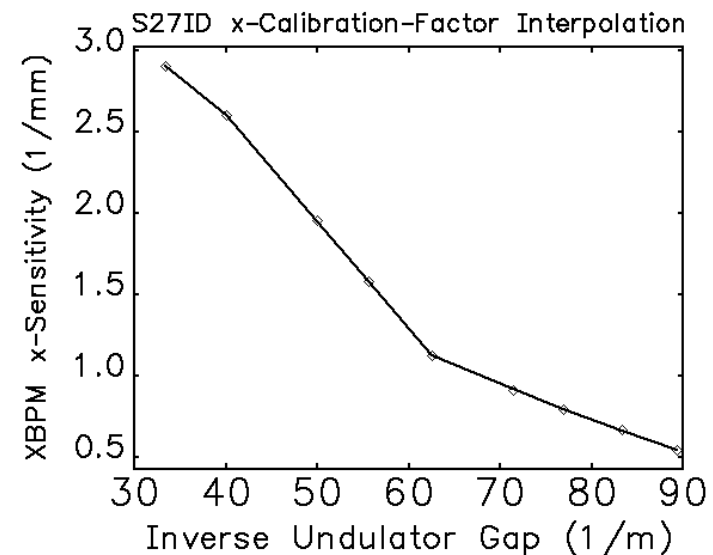
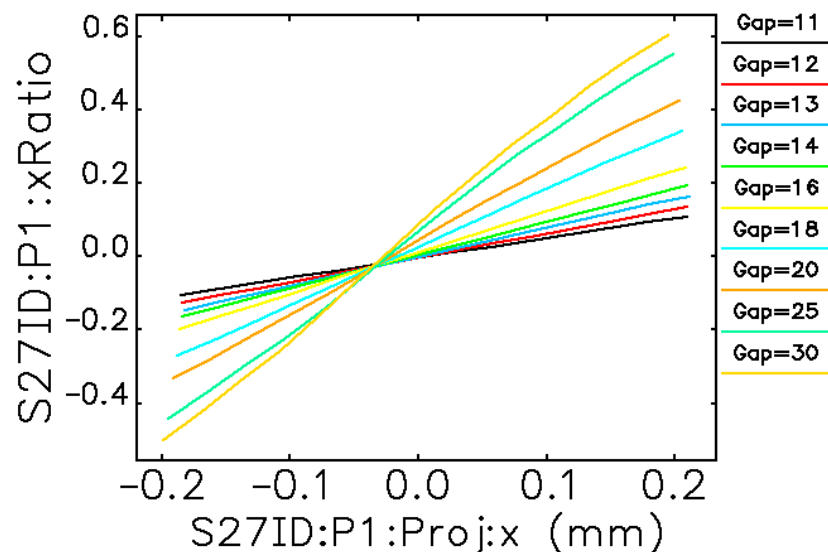

Engineering details: readout detectors (1)

Encountered serious problems with detector-grade diamond (0.5 mm thick):

- 1) Long time (20 minutes) to reach steady state.
- 2) Much higher noise than silicon PIN diodes.

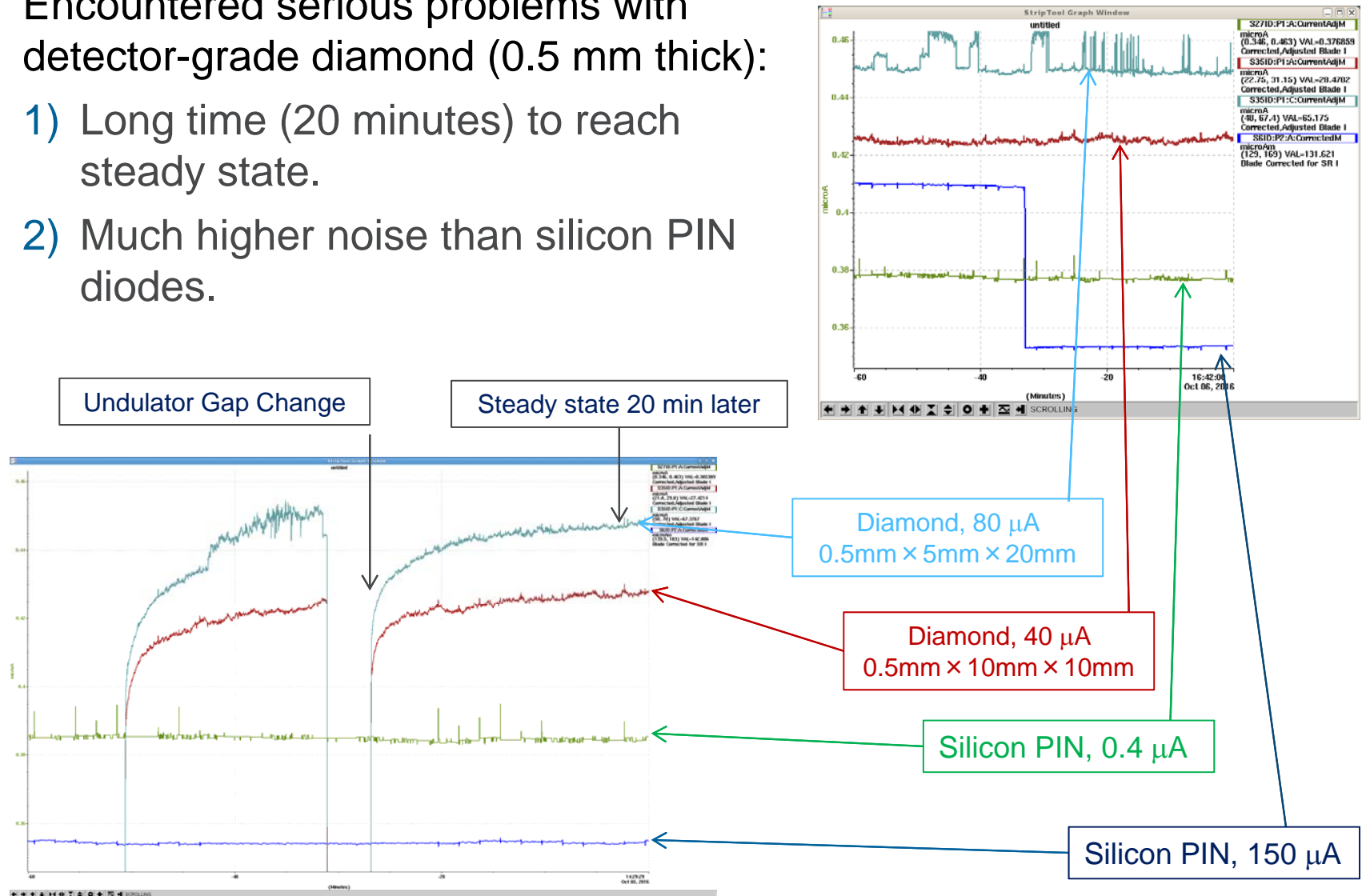

Engineering details: readout detectors (2)

Silicon PIN diode are used to read out the XRF signal. Fe K-edge intensity down-conversion is used attenuate the signal by ~ 100 -fold. Best results are obtained for signals in the range of $1 - 100 \mu\text{A}$.

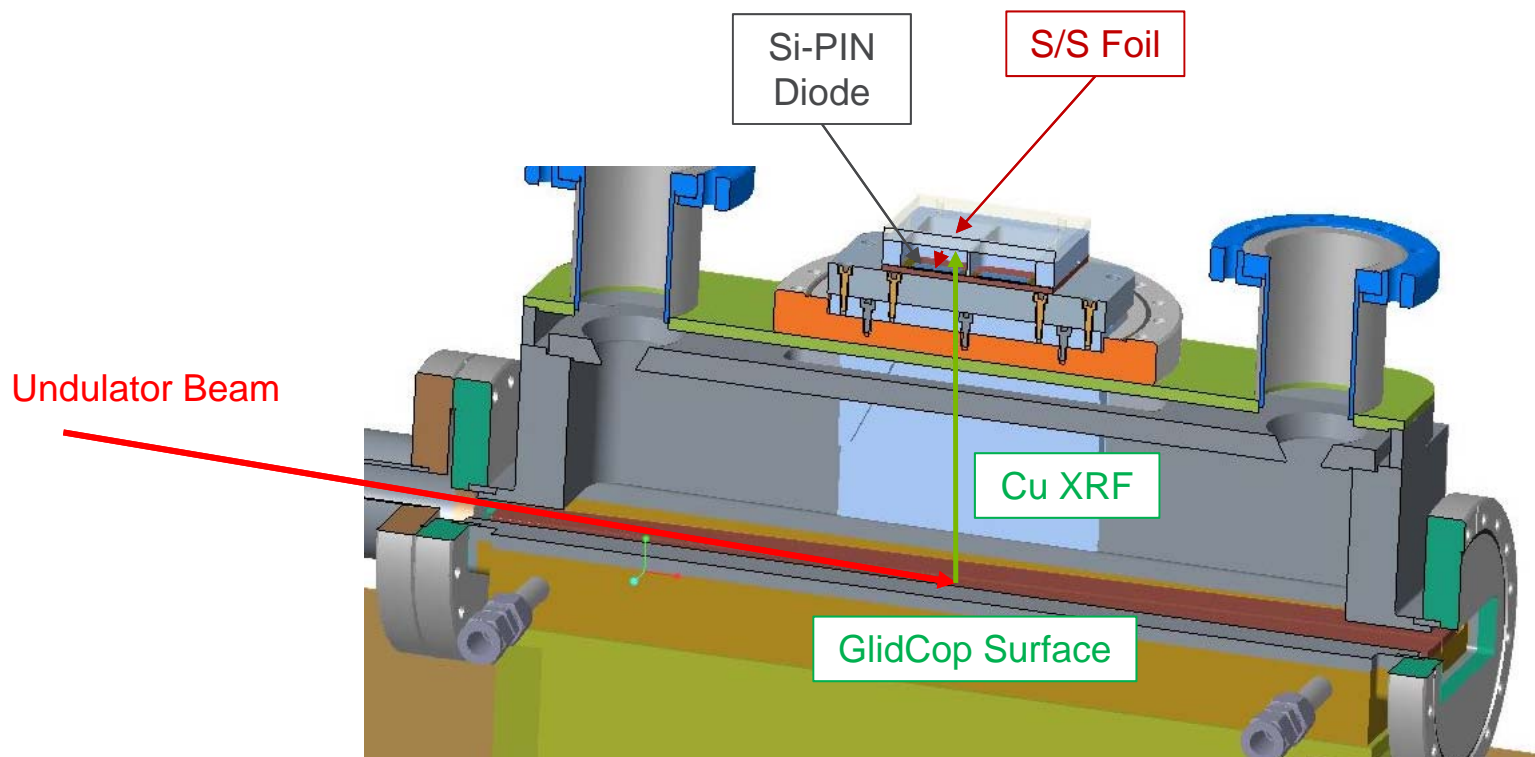

Si-PIN diodes have been the workhorse with low-noise output.

Performance: improved signal/BM ratio

GRID-XBPM demonstrated 30-fold improvement of undulator-to-BM background ratio over old photoemission XBPM.

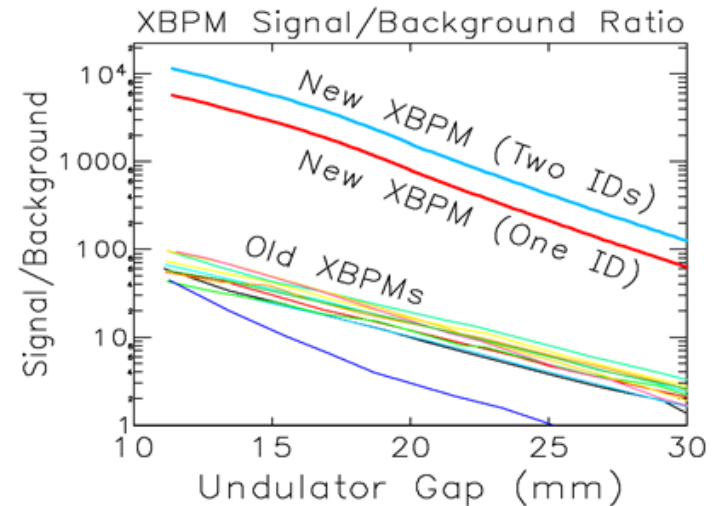

GRID-XBPM Signal/Background Ratio

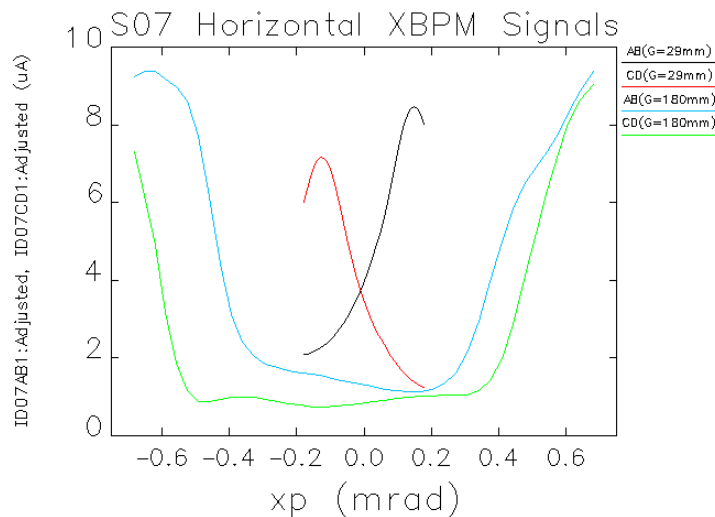

Photoemission XBPM

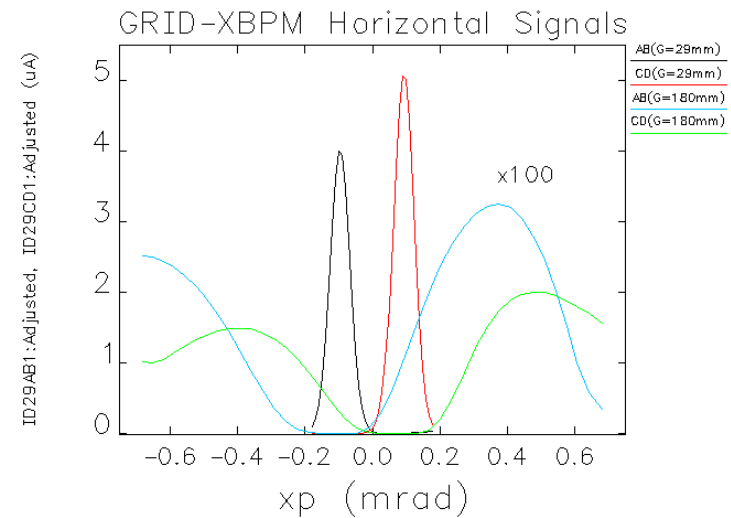

GRID-XBPM

Hard XBPM is more accurate than RFBPM

GRID-XBPM demonstrated that the hard x-ray BPM is more accurate in predicting monochromatic x-ray beam (central cone) position than the RFBPM since the latter cannot account for undulator steering.

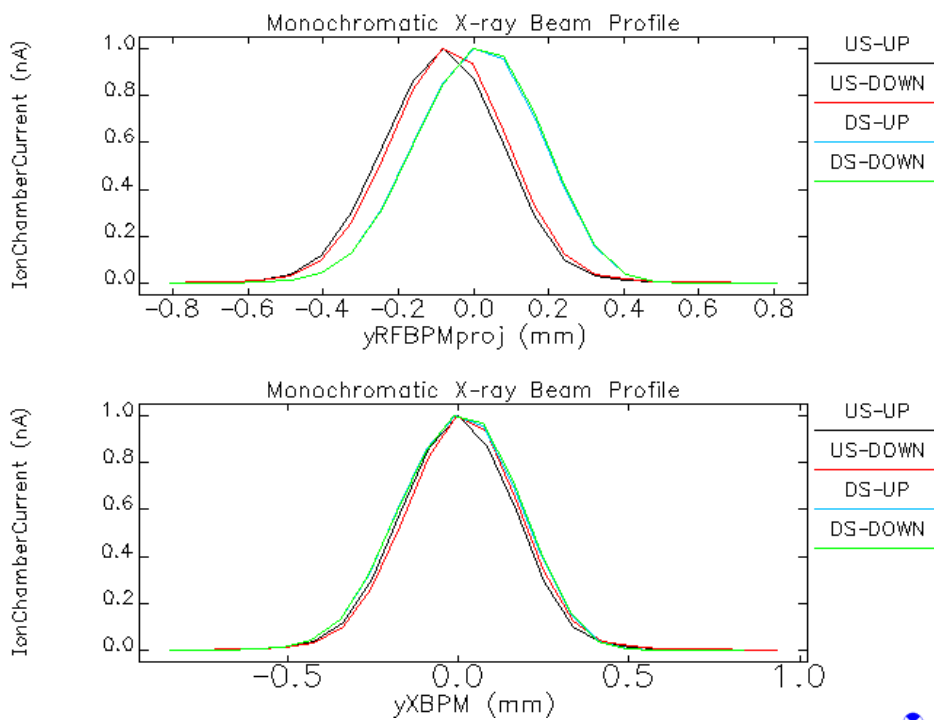

Electron Trajectory Through Upstream Undulator
(Undulator A data from Roger Dejus: U33#21, 11.5 mm)

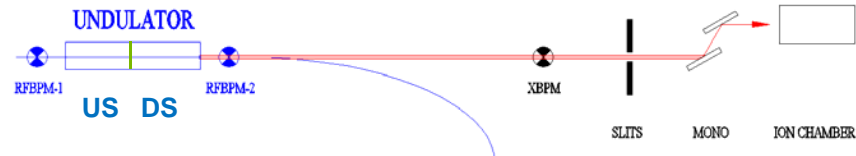
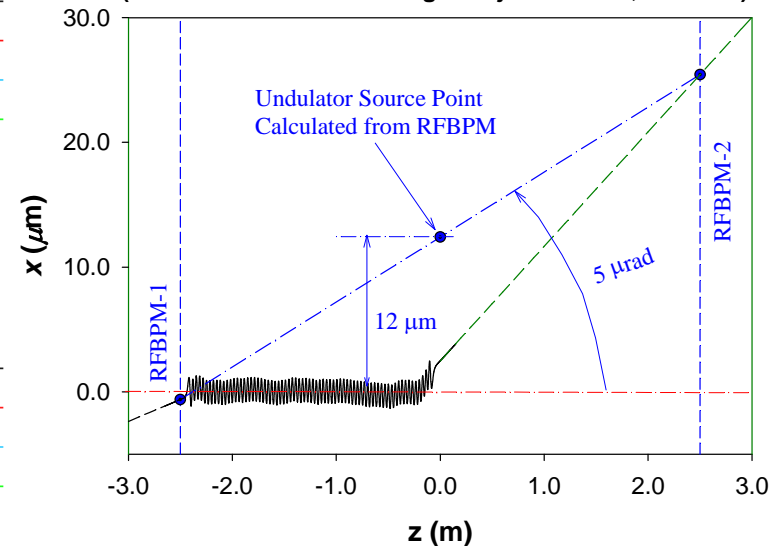

GRID-XBPM correctly reads the x-ray beam position in the beamline!

Stable operations in orbit control (27-ID)

The GRID-XBPM started service in the orbit control in July 2015. It significantly improved the angular stability of 27-ID undulator beam.

Horizontal beam positions in 60-days of User Operations

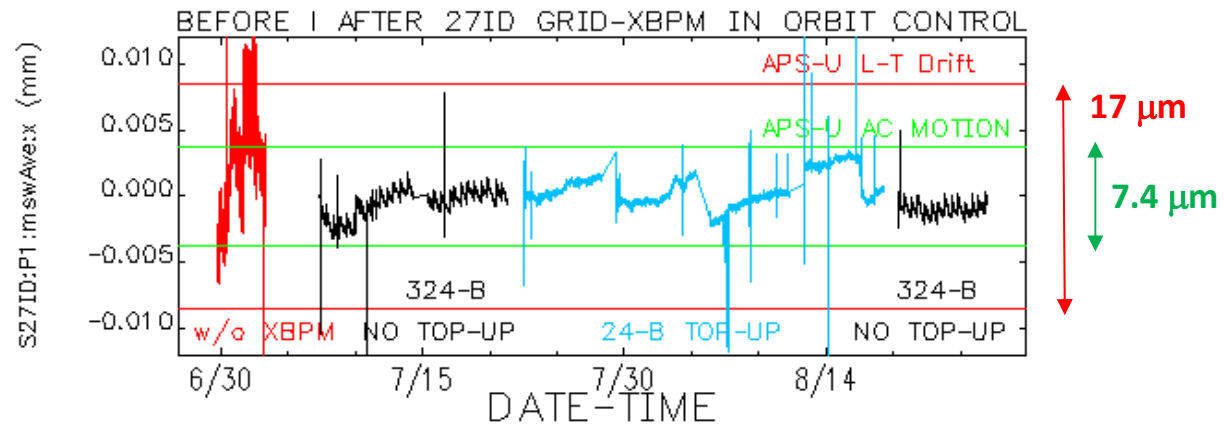

Vertical beam positions in 60-days of User Operations

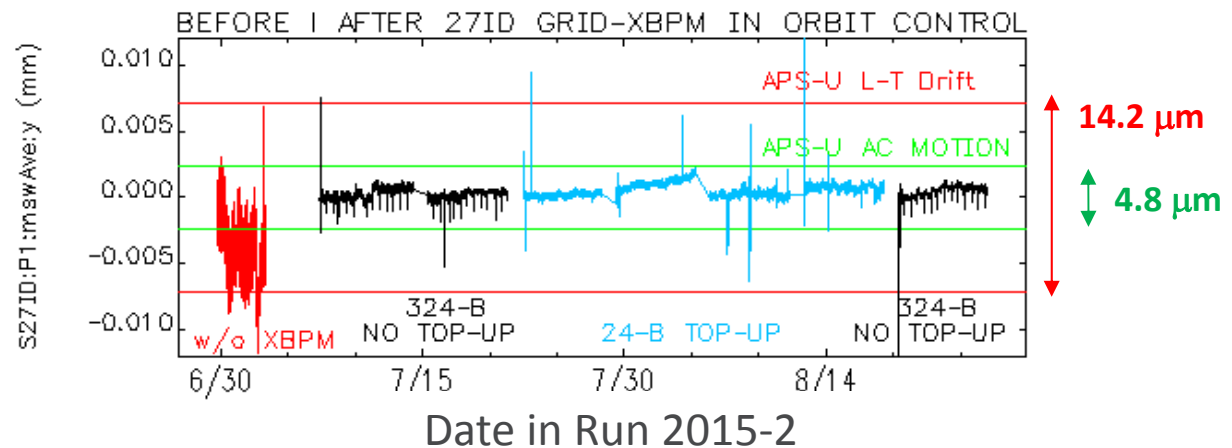

This GRID-XBPM met the APS-U specifications in both planes.

Validation: X-Y coupling and hardware defect

- First step: one-dimensional scans to fit the Diff/Sum to the projected x-ray beam center position.
- Second step: matrix scan to verify the XBPM perfection.

Example: A pair of misaligned “blades” results in a “sheared” matrix pattern

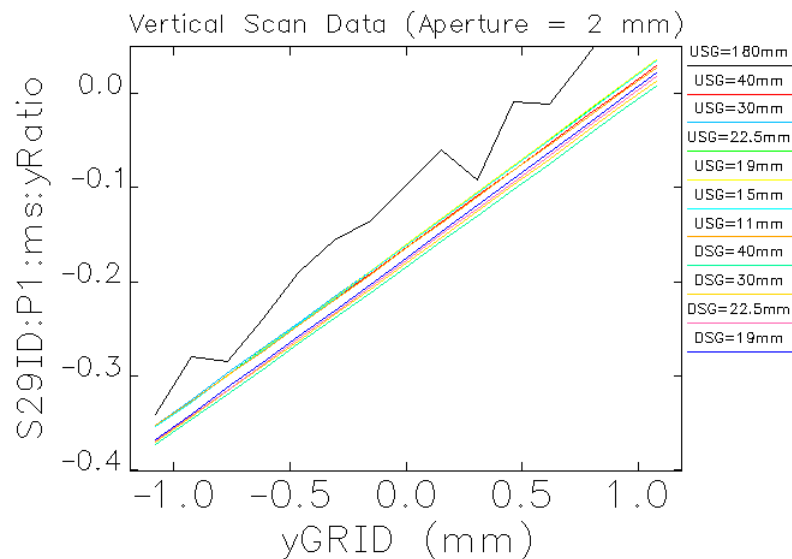

Horizontal calibration scan plots Diff/Sum against x-ray beam position.

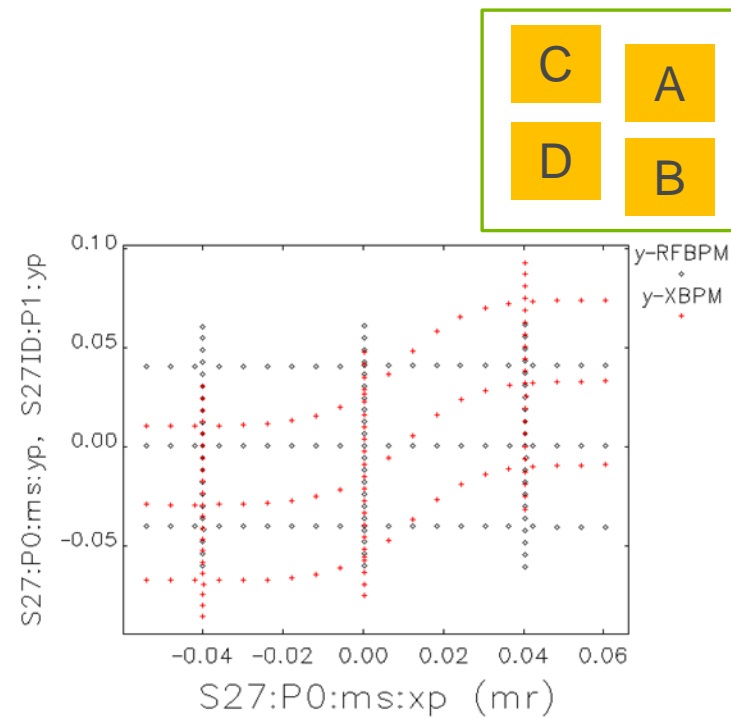

Matrix scan uncovers alignment error in the four quadrant of the XBPM.

XBPM validation: signal processing

- Best correction: realign the blades the next shutdown.
- Signal processing compensates small defects in XBPM

$$\begin{bmatrix} \Delta_x \\ \Sigma_x \\ \Delta_y \\ \Sigma_y \end{bmatrix} = \begin{bmatrix} a_{0x} & b_{0x} & c_{0x} & d_{0x} \\ a_{1x} & b_{1x} & c_{1x} & d_{1x} \\ a_{0y} & b_{0y} & c_{0y} & d_{0y} \\ a_{1y} & b_{1y} & c_{1y} & d_{1y} \end{bmatrix} \begin{bmatrix} A \\ B \\ C \\ D \end{bmatrix} - \begin{bmatrix} g_{0x} \\ g_{1x} \\ g_{0y} \\ g_{1y} \end{bmatrix}$$

$$x = k_x \frac{\Delta_x}{\Sigma_x} - x_0$$

$$y = k_y \frac{\Delta_y}{\Sigma_y} - y_0$$

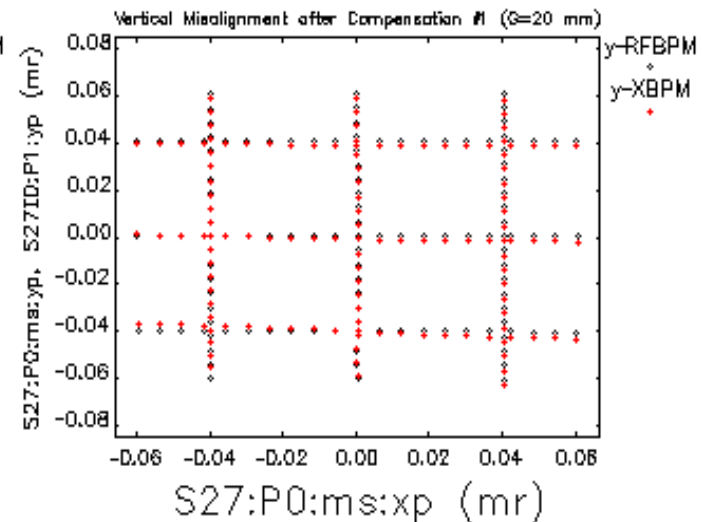
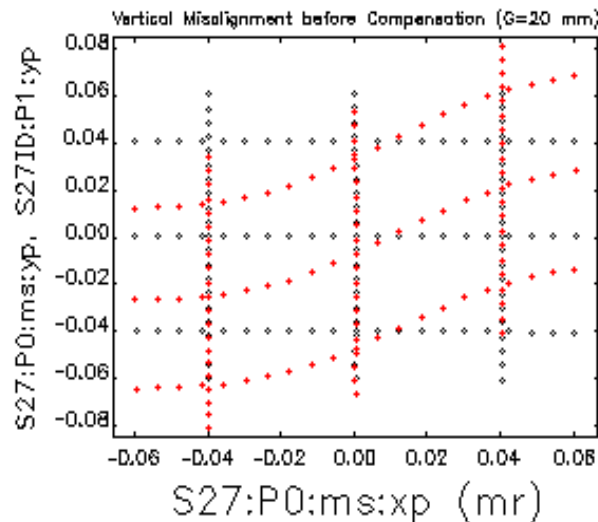
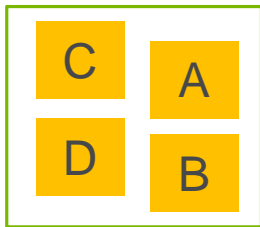

Matrix scan shows alignment error in the XBPM quadrants using conventional processing.

Blade misalignment can be partially compensated by tweaking the matrix elements in the processing formula.

Further development: Compton XBPM

For lower power undulators (10 kW), we are developing XBPM based on Compton scattering. Preliminary data shows that the signal profiles may have triple-peaked features at high undulator K.

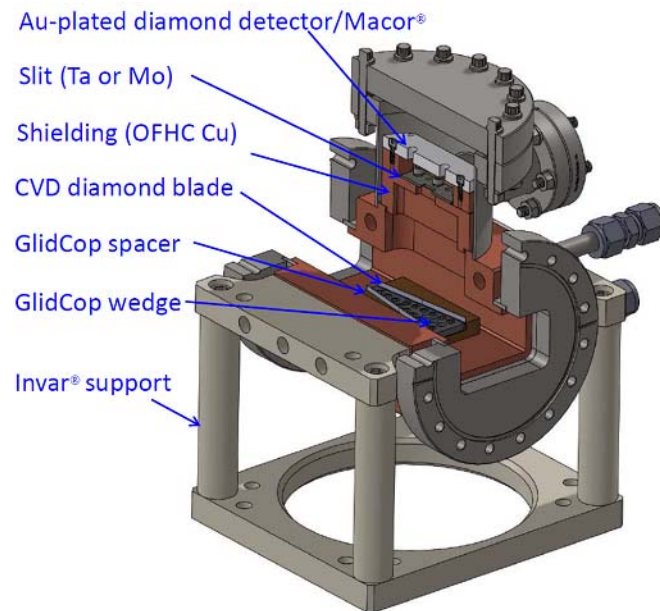

Mechanical design of the prototype Compton XBPM.

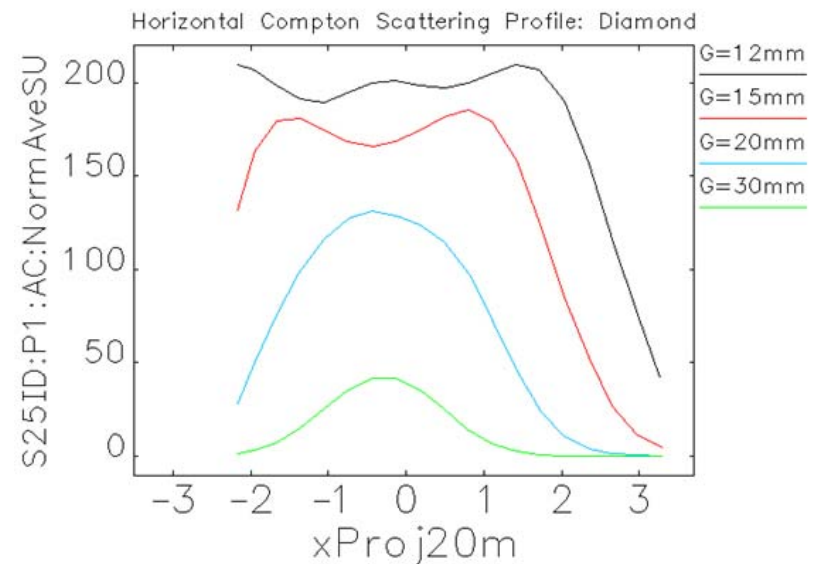

Horizontal signal profiles of the white beam Compton XBPM.

R & D in progress: Compton XBPM

The blades in the first prototype lacked horizontal symmetry and does not read horizontal position properly. A new prototype is proposed to fix the problem.

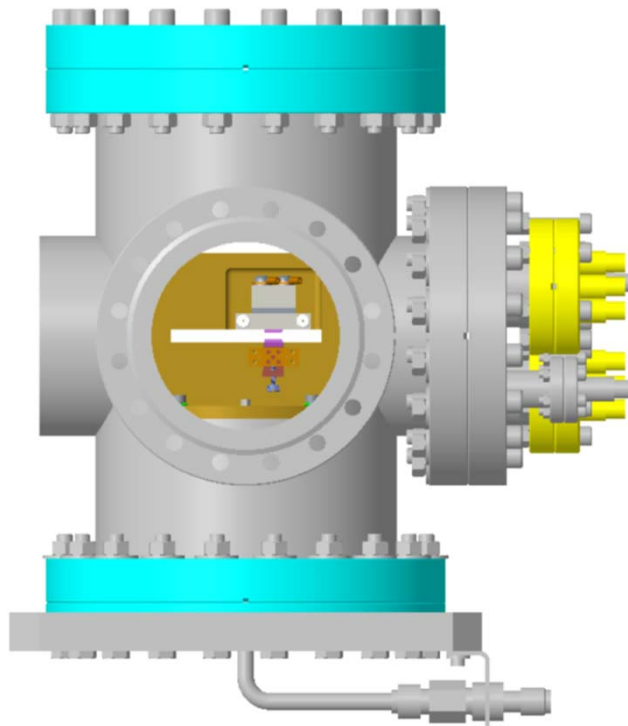

Mechanical design of the new Compton XBPM prototype.

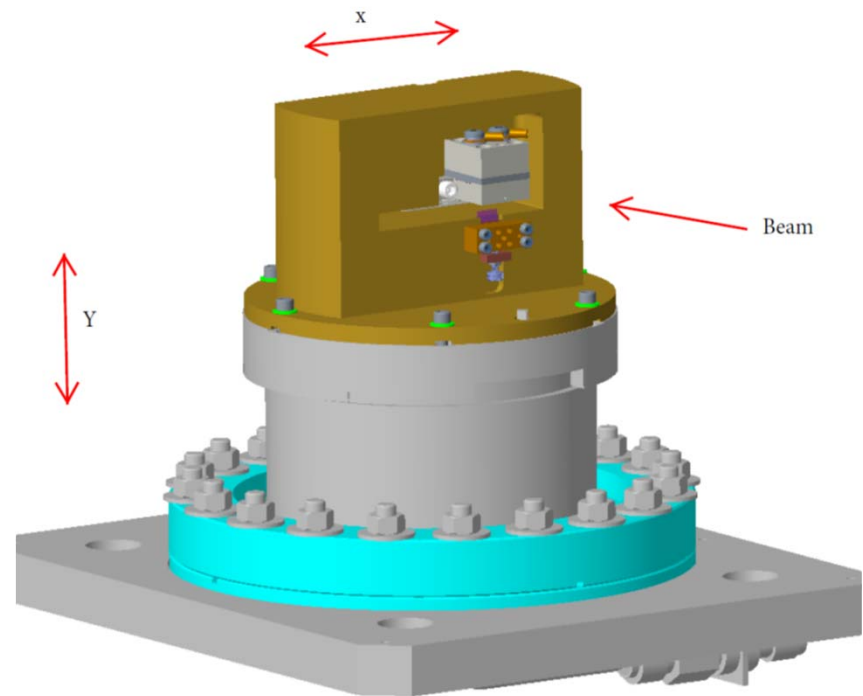

Horizontal signal profiles of the white beam Compton XBPM.

Summary

- The Next Generation XBPMs are expected to play important roles in the beam stabilization systems in the APS, a 4-th generation source.
- The NG-XBPM uses hard x-rays and their signals are closely correlated with the undulator central cone beam positions and nearly free from BM background contamination.
- We found that x-ray simulations are useful for guiding the XBPM's design and improving their performance.
- For front ends for high-power undulator sources up to 22 kW, we have successfully developed a functional design of GRID-XBPM with proven performance.
- For lower power undulator sources such as canted undulators in the APS, other design based on diamond solid ion chamber or Compton scattering may offer more cost-effective alternatives.
- R & D programs are needed to explore the alternatives and further improve the cost effectiveness of the GRID-XBPM.

The APS NG-XBPM Team

Mechanical design and installation

- Soonhong Lee (GRID-XBPM & Compton XBPM)
- Frank Westferro (XBPM2, IM1, IM2, new Compton XBPM)
- Yifei Jaski (front end integration)
- Try Leng Kruey (installation)

Data acquisition and motion control

- Michael Hahne, Adam Brill, Bob Lill (XBPM electronics)
- Jim Stevens (motion control)

X-ray physics & experimental measurements

- Glenn Decker (initial development and continued participation/support)
- Mohan Ramanathan
- Nick Sereno
- Bingxin Yang

Plus help from many people in APS