

DTXRD - software for evaluation of single crystals using x-ray diffraction

Stanislav Stoupin

Advanced Photon Source, Argonne National Laboratory

TWG meeting



Outline

- 1 Overview
- 2 X-ray diffraction characterization of single crystals
- 3 Rocking curve imaging
- 4 Dynamical diffraction calculations for a plane wave
- 5 Throughput and rocking curves of multi-crystal configurations
- 6 Summary

Acknowledgments

Carlo Segre (IIT)
Yuri Shvyd'ko (APS)
Pete Jemian (APS)

Jozef Maj (APS)
Xianrong Huang (APS)
Lahsen Assoufid (APS)
Chris Jacobsen (APS)

Kurt Goetze (APS)
Jeff Kirchman (APS)

- **dtxrd**: calculations of reflectivity/transmissivity using the dynamical theory of x-ray diffraction for monochromatic wave
- **rcpeak**: plotting and calculations of parameters of a reflectivity curve
- **rctopo**: calculations of x-ray rocking curve images (for a series of hdf4 CCD snapshots)
- **seehdf**: hdf4 image data viewer
- **specscan**: extraction of individual scans from a file generated by SPEC
- **throughput**: calculations of a throughput and rocking curves of a multicrystal configuration

online documentation:

<http://python-dtxrd.readthedocs.org>

Single crystal x-ray diffraction: Applications

Comparison of application ranges. (from D.K. Bowen, B.K. Tanner, "High Resolution X-ray Diffractometry and Topography")

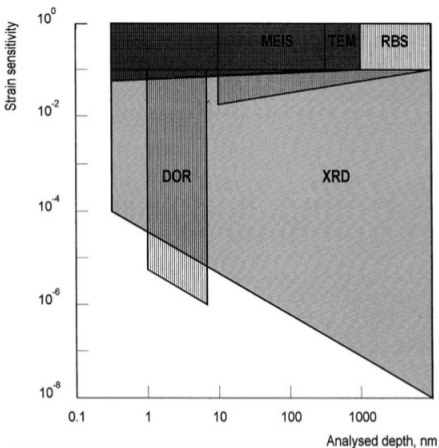

- science of crystal growth (studies of intrinsic defects)
- nondestructive evaluation and R&D in semiconductor industry
- characterization of x-ray crystal optics!

X-ray diffraction characterization of single crystals

X-ray diffraction characterization of single crystals

rocking curve measurement and analysis

example: double crystal (+,-) configuration (Bragg)

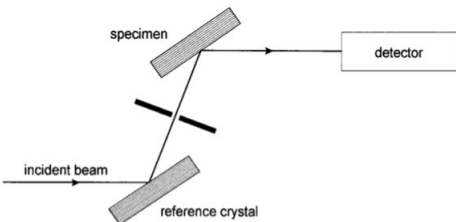

X-ray diffraction characterization of single crystals

rocking curve measurement and analysis
example: double crystal (+,-) configuration (Bragg)

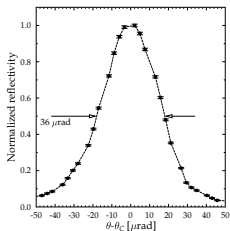
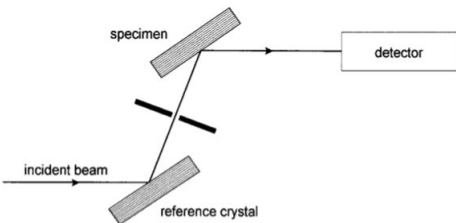

X-ray diffraction characterization of single crystals

rocking curve measurement and analysis

example: double crystal (+,-) configuration (Bragg)

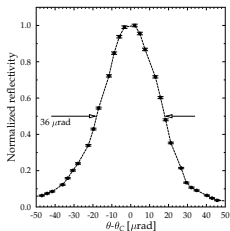
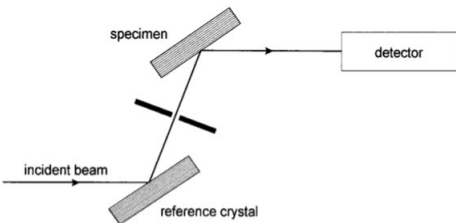

x-ray diffraction imaging

example: Lang projection topography (Laue)

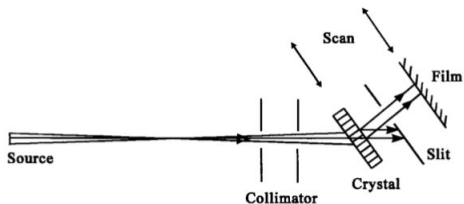

X-ray diffraction characterization of single crystals

rocking curve measurement and analysis

example: double crystal (+,-) configuration (Bragg)

x-ray diffraction imaging

example: Lang projection topography (Laue)

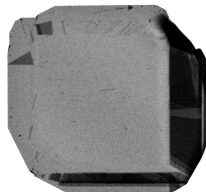
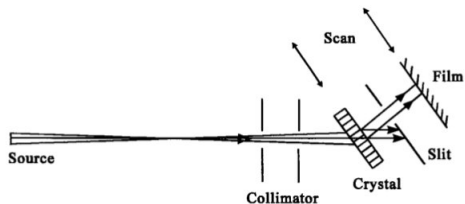
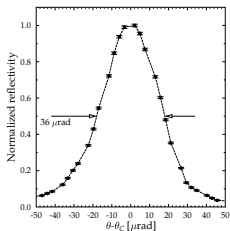
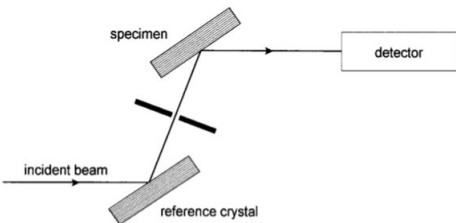

Topography station at the APS

S. Krasnicki RSI 67, 3369 (1996)

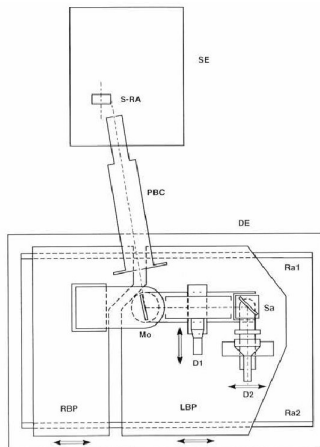
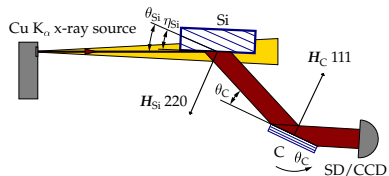
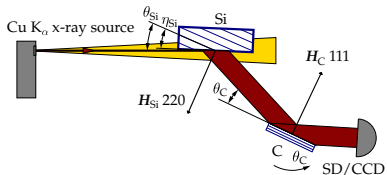

Fig. 1. General layout of the topography station.
SE - source enclosure, S-RA - source-rotating anode
PBC - primary beam collimator, DE - diffractometer enclosure
Ra 1 - rail 1, Ra2 - rail 2, Mo - monochromator, Sa - sample
D1 - detector 1, D2 - detector 2,
RBP - right base plate, LBP - left base plate

Topography station at the APS

S. Krasnicki RSI 67, 3369 (1996)



Recent improvements:

- ultraprecise angular stage for 2nd crystal
- control using EPICS and SPEC
- computer & OS upgrade

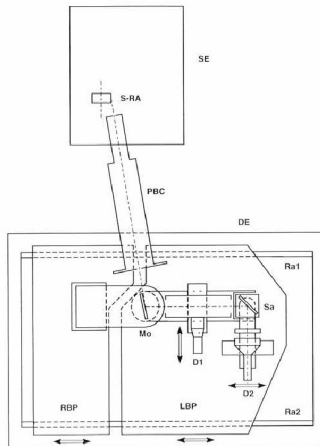
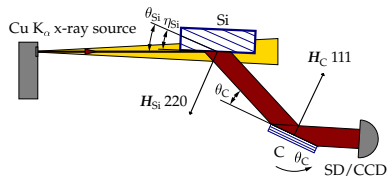

Fig. 1. General layout of the topography station.
SE - source enclosure, S-RA - source-rotating anode
PBC - primary beam collimator, DE - diffractometer enclosure
Ra 1 - rail 1, Ra2 - rail 2, Mo - monochromator, Sa - sample
D1 - detector 1, D2 - detector 2,
RBP - right base plate, LBP - left base plate

Topography station at the APS

S. Krasnicki RSI 67, 3369 (1996)



Recent improvements:

- ultraprecise angular stage for 2nd crystal
- control using EPICS and SPEC
- computer & OS upgrade

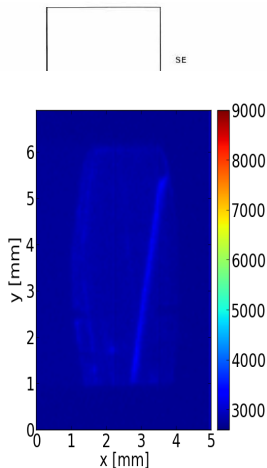

SE - source enclosure, S-RA - source-rotating anode
PBC - primary beam collimator, DE - diffractometer enclosure
Ra1 - rail 1, Ra2 - rail 2, Mo - monochromator, Sa - sample
D1 - detector 1, D2 - detector 2,
RBP - right base plate, LBP - left base plate

Rocking curve imaging

rctopo: Sort sequence of diffraction images on per-pixel basis to generate local rocking curves. First demonstrated by Lübbert et al., NIM B, 160 (2000).

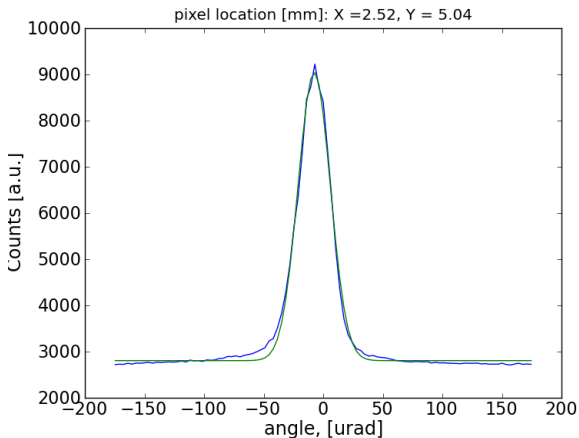

Rocking curve imaging

rctopo: Sort sequence of diffraction images on per-pixel basis to generate local rocking curves. First demonstrated by Lübbert et al., NIM B, 160 (2000).

Rocking curve topographs: Gaussian curve fit. Sample: diamond1

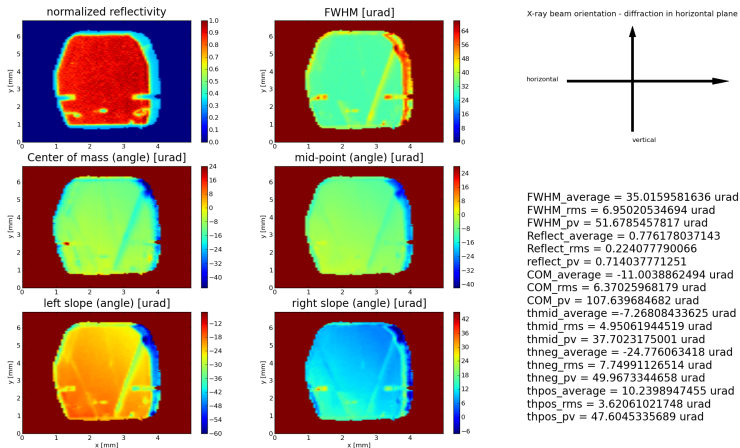

- brings spatial resolution to rocking curve analysis
- ultraprecise evaluation of strain and lattice tilt for single crystals
- a starting point to explore wavefront preservation properties of diffracting optics
- use of a synchrotron source would improve spatial resolution (to 1 μm) and wavefront resolution (to 0.1 μrad).

Topo station at APS: possible improvements

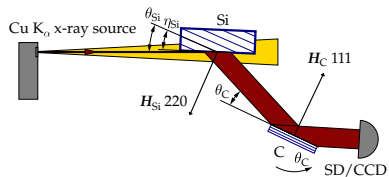

Topo station at APS: possible improvements

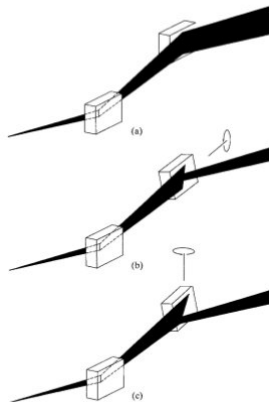
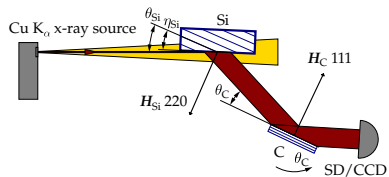

- upgrade CCD to achieve better spatial resolution (60 μm \rightarrow 13 μm pixel size is feasible)
- control all 3 angles for the sample - facilitate search of optimal condition
- use triple axis system with analyzer crystal in front of CCD - improve wavefront sensitivity

Topo station at APS: possible improvements

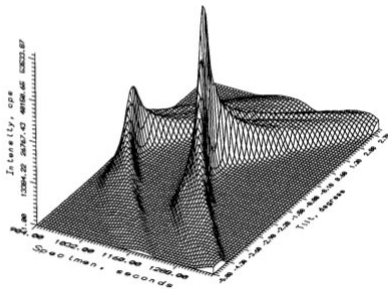
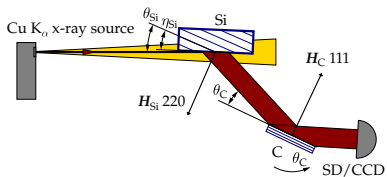

- upgrade CCD to achieve better spatial resolution (60 μm \rightarrow 13 μm pixel size is feasible)
- control all 3 angles for the sample - facilitate search of optimal condition
- use triple axis system with analyzer crystal in front of CCD - improve wavefront sensitivity

dtxrd: reflectivity and transmissivity (plane wave)

Bragg case

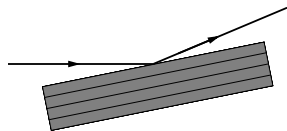

Laue case

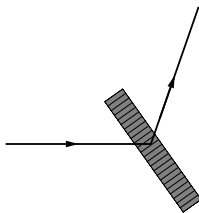

dtxrd: reflectivity and transmissivity (plane wave)

Bragg case

```
dtxrd Si 1 1 1 0 0 300 20 e 10
```

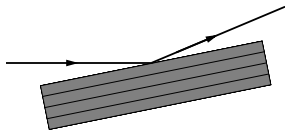

Laue case

```
dtxrd C 0 0 4 90 0 300 0.1 e 12
```

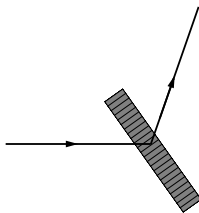

dtxrd: reflectivity and transmissivity (plane wave)

Bragg case

```
dtxrd Si 1 1 1 0 0 300 20 e 10
```

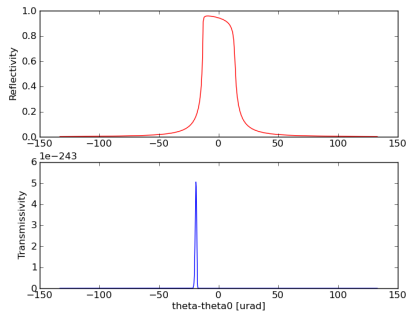

Laue case

```
dtxrd C 0 0 4 90 0 300 0.1 e 12
```

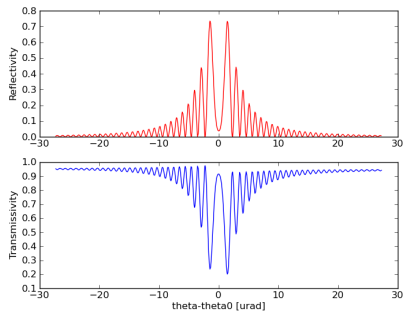

dtxrd: dynamical diffraction calculations for plane wave

- calculates reflectivity/transmissivity and various parameters of a given reflection in arbitrary geometry for a given energy or angle of incidence.
- includes backscattering cases
- crystal thickness and temperature are input parameters
- available crystal models: Si, C (diamond), Ge, Al₂O₃ (sapphire)

Limitations:

- only 2-beam Bragg or Laue case
- only perfect crystals
- only plane monochromatic wave
- grazing incidence and grazing emergence are not included

How to simulate a real case (multi-crystal configuration, source divergence and energy bandwidth)?

- introduce a regular 2D grid that will cover angular and energy acceptance of the first crystal in a multi-crystal configuration
- introduce energy and angular distribution of the source in this region
- propagate each ray through analytical formulas of 2-beam diffraction for a sequence of reflections
- for calculations of a rocking curve - perform this procedure for a sequence of angular positions of the crystal of interest

throughput: double-crystal high heat load mono

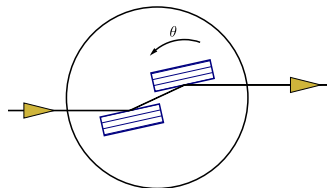

courtesy of Z. Liu, S. Heald et al.

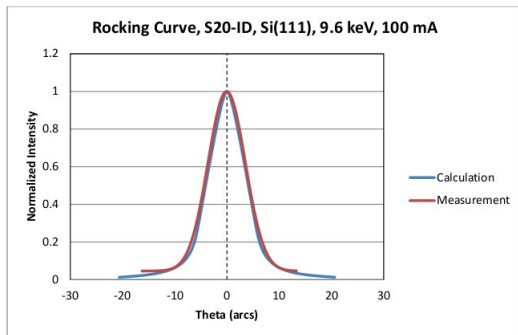

experiment: $\Delta\theta \simeq 8.5$ arcsec (FWHM)

theory (**throughput** calculation): $\Delta\theta \simeq 8.0$ arcsec (FWHM)

throughput: double-crystal high heat load mono

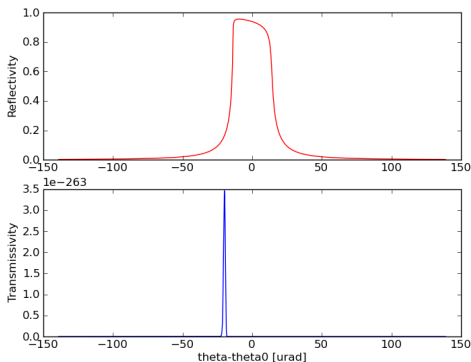
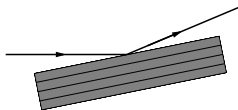

experiment: $\Delta\theta \simeq 8.5$ arcsec (FWHM)

theory (**dtxrd** calculation): $\Delta\theta \simeq 5.7$ arcsec (FWHM)

throughput: double-crystal topography

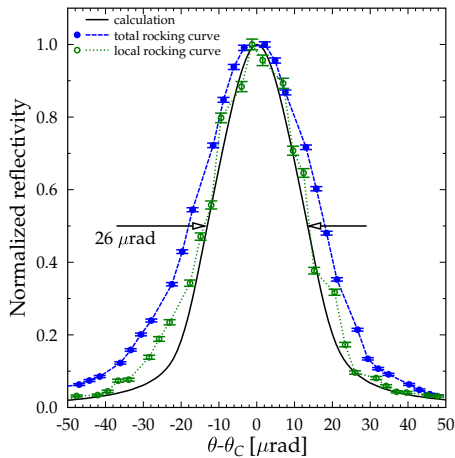
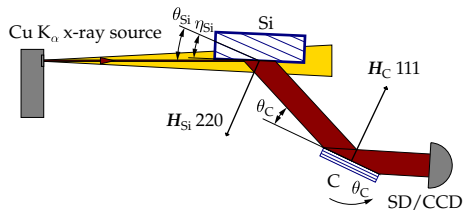

throughput: 4-bounce mono (MERIX)

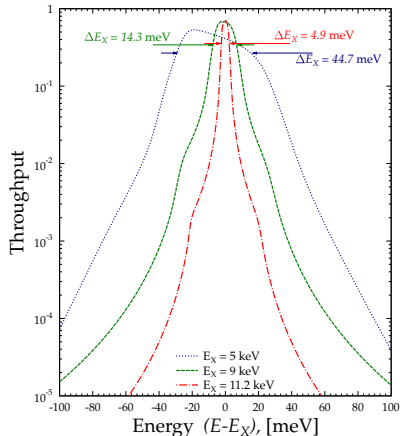
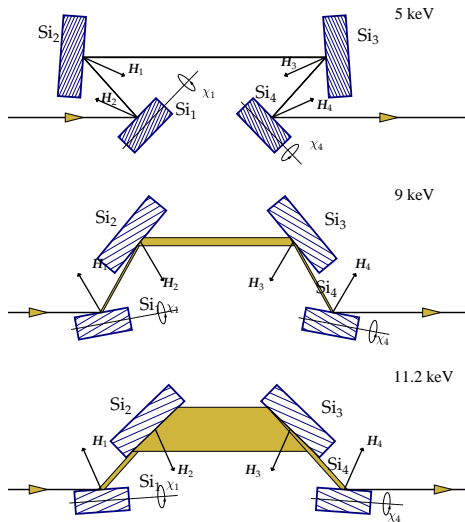

throughput: multi-crystal configurations

- calculates throughput and rocking curves for divergent incident beam with finite energy bandwidth
- includes backscattering cases
- source energy distribution can be assigned
- available crystal models: Si, C (diamond), Ge, Al₂O₃ (sapphire)

Limitations:

- only 2-beam Bragg or Laue case
- only perfect crystals
- angular spread only in scattering plane
- grazing incidence and grazing emergence are not included
- infinite wavefront

Summary

- documentation: <http://python-dtxrd.readthedocs.org>
- availability (APS Linux): `/APSshare/epd/rh6-x86_64/bin`
- source: <https://subversion.xray.aps.anl.gov/dtxrd>
- a goal to improve and make more user-friendly!

references:

- 1 S. Stoupin, V. Blank, S. Terentyev, S. Polyakov, V. Denisov, M. Kuznetsov, Y. Shvyd'ko, D. Shu, P. Emma, J. Maj, et al., *Diamond and Related Materials* 33, 1 (2013)
- 2 S. Stoupin, Y. V. Shvyd'ko, D. Shu, V. D. Blank, S. A. Terentyev, S. N. Polyakov, M. S. Kuznetsov, I. Lemesh, K. Mundboth, S. P. Collins, et al., *Opt. Express* 21, 30932 (2013)
- 3 S. Stoupin, S. Terentyev, V. Blank, Y. Shvyd'ko, K. Goetze, L. Assoufid, S.N.Polyakov, M.S. Kuznetsov, N. Kornilov, J. Katsoudas, et al. (2014), submitted for publication, URL [arXiv:1401.5879](https://arxiv.org/abs/1401.5879).

Great Stuff to Read!

