

**Agilent 34401A**  
**6 ½ Digit Multimeter**

**User's Guide**



**Agilent Technologies**

# Notices

© Agilent Technologies, Inc. 1991 - 2007

No part of this manual may be reproduced in any form or by any means (including electronic storage and retrieval or translation into a foreign language) without prior agreement and written consent from Agilent Technologies, Inc. as governed by United States and international copyright laws.

## Manual Part Number

34401-90004

## Edition

Seventh Edition. August 2007

Printed in Malaysia

Agilent Technologies, Inc.  
3501 Stevens Creek Blvd.  
Santa Clara, CA 95052 USA

Microsoft® and Windows® are U.S. registered trademarks of Microsoft Corporation.

## Software Revision

This guide is valid for the firmware that was installed in the instrument at the time of manufacture. However, upgrading the firmware may add or change product features. For the latest firmware and documentation, go to the product page at:

[www.agilent.com/find/34401A](http://www.agilent.com/find/34401A)

## Warranty

**The material contained in this document is provided “as is,” and is subject to being changed, without notice, in future editions. Further, to the maximum extent permitted by applicable law, Agilent disclaims all warranties, either express or implied, with regard to this manual and any information contained herein, including but not limited to the implied warranties of merchantability and fitness for a particular purpose. Agilent shall not be liable for errors or for incidental or consequential damages in connection with the furnishing, use, or performance of this document or of any information contained herein. Should Agilent and the user have a separate written agreement with warranty terms covering the material in this document that conflict with these terms, the warranty terms in the separate agreement shall control.**

## Technology Licenses

The hardware and/or software described in this document are furnished under a license and may be used or copied only in accordance with the terms of such license.

## Restricted Rights Legend

U.S. Government Restricted Rights. Software and technical data rights granted to the federal government include only those rights customarily provided to end user customers. Agilent provides this customary commercial license in Software and technical data pursuant to FAR 12.211 (Technical Data) and 12.212 (Computer Software) and, for the Department of Defense, DFARS 252.227-7015 (Technical Data - Commercial Items) and DFARS 227.7202-3 (Rights in Commercial Computer Software or Computer Software Documentation).

## Safety Notices

### CAUTION

A **CAUTION** notice denotes a hazard. It calls attention to an operating procedure, practice, or the like that, if not correctly performed or adhered to, could result in damage to the product or loss of important data. Do not proceed beyond a **CAUTION** notice until the indicated conditions are fully understood and met.

---

### WARNING

A **WARNING** notice denotes a hazard. It calls attention to an operating procedure, practice, or the like that, if not correctly performed or adhered to, could result in personal injury or death. Do not proceed beyond a **WARNING** notice until the indicated conditions are fully understood and met.

---

# Safety Information

## General

Do not use this product in any manner not specified by the manufacturer. The protective features of this product may be impaired if it is used in a manner not specified in the operation instructions.

Do not install substitute parts or perform any unauthorized modification to the product. Return the product to an Agilent Technologies Sales and Service Office for service and repair to ensure that safety features are maintained.

## Ground the Instrument

If your product is provided with a grounding-type power plug, the instrument chassis and cover must be connected to an electrical ground to minimize shock hazard. The ground pin must be firmly connected to an electrical ground (safety ground) terminal at the power outlet. Any interruption of the protective (grounding) conductor or disconnection of the protective earth terminal will cause a potential shock hazard that could result in personal injury.

## Cleaning

Clean the outside of the instrument with a soft, lint-free, slightly dampened cloth. Do not use detergent or chemical solvents.

## Safety Symbols



Earth Ground



Chassis Ground



Risk of electric shock



Refer to manual for additional safety information



Alternating Current



On supply



Off supply



'In' position of bi-stable push switch



'Out' position of bi-stable push switch

**CAT II (300V)** IEC Measurement Category II. Inputs may be connected to mains (up to 300 VAC) under Category II overvoltage conditions.

## WARNING

**Main Power and Test Input Disconnect: Unplug instrument from wall outlet, remove power cord, and remove all probes from all terminals before servicing. Only qualified, service-trained personnel should remove the cover from the instrument.**

## WARNING

**Line and Current Protection Fuses: For continued protection against fire, replace the line fuse and the current-protection fuse only with fuses of the specified type and rating.**

## WARNING

**Front/Rear Switch: Do not change the position of the Front/Rear switch on the front panel while signals are present on either the front or rear set of terminals. The switch is not intended as an active multiplexer. Switching while high voltages or currents are present may cause instrument damage and lead to the risk of electric shock.**

## WARNING

**IEC Measurement Category II.** The HI and LO input terminals may be connected to mains in IEC Category II installations for line voltages up to 300 VAC. To avoid the danger of electric shock, do not connect the inputs to mains for line voltages above 300 VAC. See "IEC Measurement Category II Overvoltage Protection" on the following page for further information.

## WARNING

**Protection Limits: To avoid instrument damage and the risk of electric shock, do not exceed any of the Protection Limits defined in the following section.**

### Protection Limits

The Agilent 34401A Digital Multimeter provides protection circuitry to prevent damage to the instrument and to protect against the danger of electric shock, provided the Protection Limits are not exceeded. To ensure safe operation of the instrument, do not exceed the Protection Limits shown on the front and rear panel, and defined as follows:

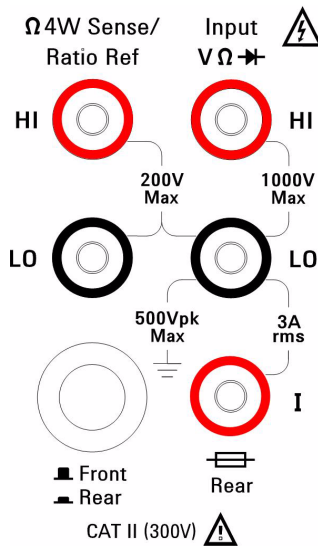

**Note:** The front-panel terminals are shown above. The rear-panel terminals are identical. The Front/Rear switch selects the terminal set to be used. *Do not operate this switch while signals are present on the front or rear terminals.* The current-protection fuse is on the rear panel.

### Input Terminal Protection Limits

Protection Limits are defined for the input terminals:

**Main Input (HI and LO) Terminals.** The HI and LO input terminals are used for voltage, resistance, frequency (period), and diode test measurements. Two Protection Limits are defined for these terminals:

**HI to LO Protection Limit.** The Protection Limit from HI to LO (Input terminals) is 1000 VDC or 750 VAC, which is also the maximum voltage measurement. This limit can also be expressed as 1000 Vpk maximum.

**LO to Ground Protection Limit.** The LO input terminal can safely "float" a maximum of 500 Vpk relative to ground.

As is implied by the above limits, the Protection Limit for the HI input terminal is a maximum of 1500 Vpk relative to ground.

**Current Input Terminal.** The current input ("I") terminal has a Protection Limit of 3A (rms) maximum current flowing from the LO input terminal. Note that the current input terminal will be at approximately the same voltage as the LO terminal.

**Note:** The current-protection circuitry includes a fuse on the rear panel. To maintain protection, replace this fuse only with a fuse of the specified type and rating.

### Sense Terminal Protection Limits

The HI and LO sense terminals are used only for four-wire resistance and temperature measurements ("Ω 4W"). The Protection Limit is 200 Vpk for all of the terminal pairings:

- LO sense to LO input
- HI sense to LO input
- HI sense to LO sense

**Note:** The 200 Vpk limit on the sense terminals is the Protection Limit. Operational voltages in resistance measurements are much lower — less than 10 V in normal operation.

### IEC Measurement Category II Overvoltage Protection

To protect against the danger of electric shock, the Agilent 34401A Digital Multimeter provides overvoltage protection for line-voltage mains connections meeting **both** of the following conditions:

The HI and LO input terminals are connected to the mains under Measurement Category II conditions, defined below, **and**

The mains are limited to a maximum line voltage of 300 VAC.

IEC Measurement Category II includes electrical devices connected to mains at an outlet on a branch circuit. Such devices include most small appliances, test equipment, and other devices that plug into a branch outlet or socket. The 34401A may be used to make measurements with the HI and LO inputs connected to mains in such devices, or to the branch outlet itself (up to 300 VAC). However, the 34401A may not be used with its HI and LO inputs connected to mains in permanently installed electrical devices such as the main circuit-breaker panel, sub-panel disconnect boxes, or permanently wired motors. Such devices and circuits are subject to overvoltages that may exceed the protection limits of the 34401A.

**Note:** Voltages above 300 VAC may be measured only in circuits that are isolated from mains. However, transient overvoltages are also present on circuits that are isolated from mains. The Agilent 34401A are designed to safely withstand occasional transient overvoltages up to 2500 Vpk. Do not use this equipment to measure circuits where transient overvoltages could exceed this level.

## Additional Notices

### Waste Electrical and Electronic Equipment (WEEE) Directive 2002/96/EC

This product complies with the WEEE Directive (2002/96/EC) marking requirement. The affixed product label (see below) indicates that you must not discard this electrical/electronic product in domestic household waste.

**Product Category:** With reference to the equipment types in the WEEE directive Annex 1, this product is classified as a "Monitoring and Control instrumentation" product.

Do not dispose in domestic household waste.

To return unwanted products, contact your local Agilent office, or see [www.agilent.com/environment/product](http://www.agilent.com/environment/product) for more information.



### Agilent 34138A Test Lead Set

The Agilent 34401A is compatible with the Agilent 34138A Test Lead Set described below.

#### Test Lead Ratings

Test Leads - 1000V, 15A

Fine Tip Probe Attachments - 300V, 3A

Mini Grabber Attachment - 300V, 3A

SMT Grabber Attachments - 300V, 3A

#### Operation

The Fine Tip, Mini Grabber, and SMT Grabber attachments plug onto the probe end of the Test Leads.

#### Maintenance

If any portion of the Test Lead Set is worn or damaged, do not use. Replace with a new Agilent 34138A Test Lead Set.

## WARNING

**If the Test Lead Set is used in a manner not specified by Agilent Technologies, the protection provided by the Test Lead Set may be impaired. Also, do not use a damaged or worn Test Lead Set. Instrument damage or personal injury may result.**



**Manufacturer's Name:** Agilent Technologies, Incorporated  
**Manufacturer's Address:** 815 – 14<sup>th</sup> St. SW  
Loveland, Colorado 80537  
USA

**Declares, that the product**

**Product Name:** Multimeter  
**Model Number:** 34401A  
**Product Options:** *This declaration covers all options of the above product(s).*

**Conforms with the following European Directives:**

*The product herewith complies with the requirements of the Low Voltage Directive 73/23/EEC and the EMC Directive 89/336/EEC (including 93/68/EEC) and carries the CE Marking accordingly.*

**Conforms with the following product standards:**

<b>EMC</b>	<b>Standard</b>	<b>Limit</b>
	IEC 61326-1:1997+A1:1998 / EN 61326-1:1997+A1:1998	
	CISPR 11:1990 / EN 55011:1991	Group 1 Class A
	IEC 61000-4-2:1995+A1:1998 / EN 61000-4-2:1995	4kV CD, 8kV AD
	IEC 61000-4-3:1995 / EN 61000-4-3:1995	3 V/m, 80-1000 MHz
	IEC 61000-4-4:1995 / EN 61000-4-4:1995	0.5kV signal lines, 1kV power lines
	IEC 61000-4-5:1995 / EN 61000-4-5:1995	0.5 kV line-line, 1 kV line-ground
	IEC 61000-4-6:1996 / EN 61000-4-6:1996	3V, 0.15-80 MHz
	IEC 61000-4-11:1994 / EN 61000-4-11:1994	Dips: 30% 10ms; 60% 100ms
		Interrupt > 95% @5000ms
	Canada: ICES-001:1998	
	Australia/New Zealand: AS/NZS 2064.1	

*The product was tested in a typical configuration with Agilent Technologies test systems.*

<b>Safety</b>	<b>Standard</b>
	IEC 61010-1:1990+A1:1992+A2:1995 / EN 61010-1:1993+A2:1995
	Canada: CSA C22.2 No. 1010.1:1992
	UL 3111-1: 1994

18 July 2001

Date

**Ray Corson**

Product Regulations Program Manager

---

**Note:** Unless otherwise indicated, this manual applies to all Serial Numbers.

The Agilent Technologies 34401A is a 6½-digit, high-performance digital multimeter. Its combination of bench-top and system features makes this multimeter a versatile solution for your measurement needs now and in the future.

### **Convenient Bench-Top Features**

- Highly visible vacuum-fluorescent display
- Built-in math operations
- Continuity and diode test functions
- Hands-free, *Reading Hold* feature
- Portable, ruggedized case with non-skid feet

### **Flexible System Features**

- GPIB (IEEE-488) interface and RS-232 interface
- Standard programming languages: SCPI, Agilent 3478A, and Fluke 8840
- Reading rates up to 1000 readings per second
- Storage for up to 512 readings
- Limit testing with pass/fail signals
- Optional *34812A BenchLink/Meter Software* for Microsoft® Windows™

---

# Agilent 34401A Multimeter

# The Front Panel at a Glance

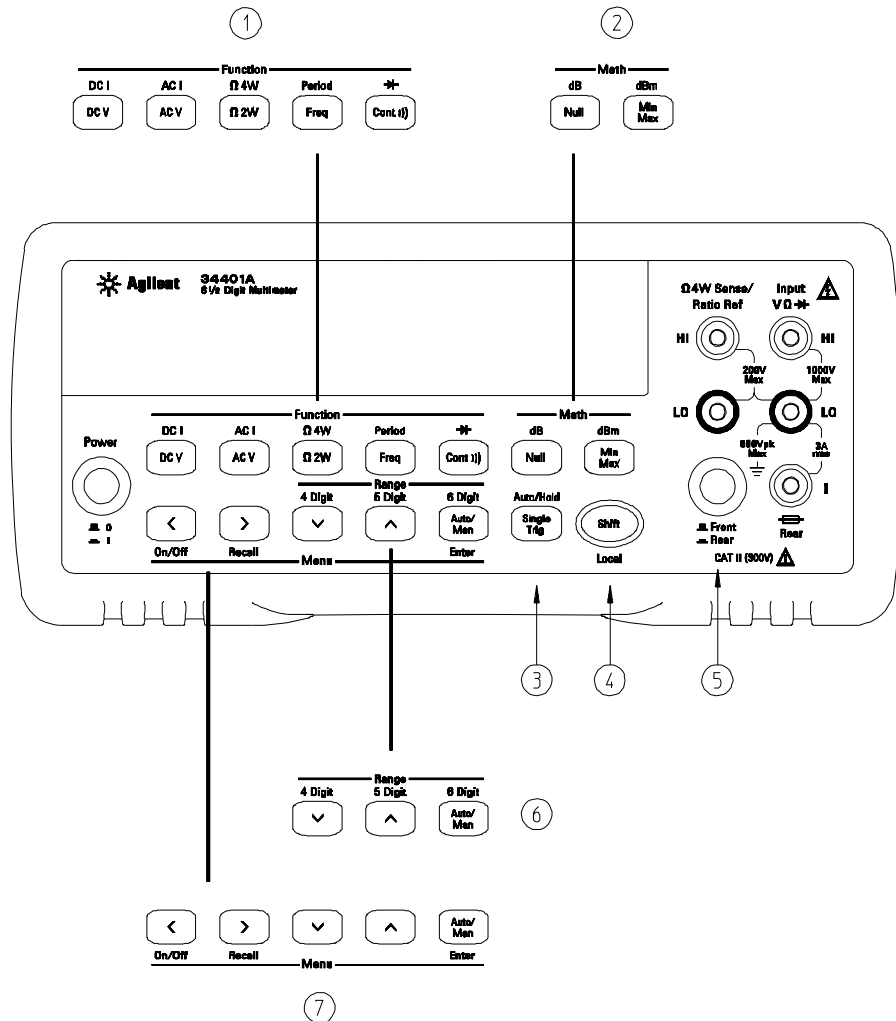

- 1 Measurement Function keys
- 2 Math Operation keys
- 3 Single Trigger / Autotrigger / Reading Hold key
- 4 Shift / Local key
- 5 Front / Rear Input Terminal Switch
- 6 Range / Number of Digits Displayed keys
- 7 Menu Operation keys



---

# The Front-Panel Menu at a Glance

The menu is organized in a top-down tree structure with three levels.

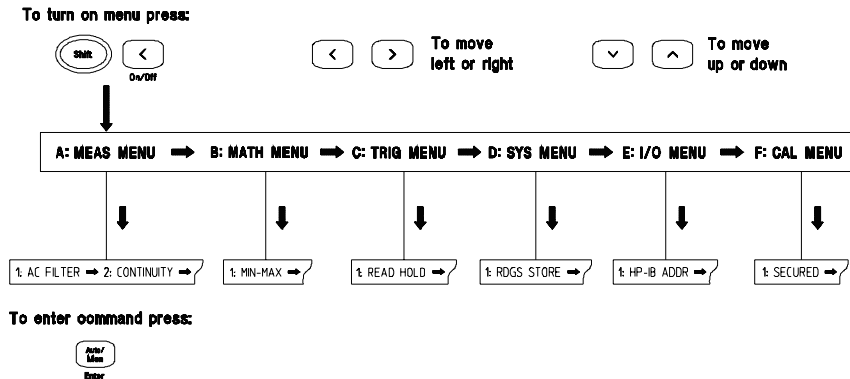
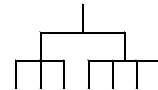

## A: MEASurement MENU

1: AC FILTER > 2: CONTINUITY > 3: INPUT R > 4: RATIO FUNC > 5: RESOLUTION

## B: MATH MENU

1: MIN-MAX > 2: NULL VALUE > 3: dB REL > 4: dBm REF R > 5: LIMIT TEST > 6: HIGH LIMIT > 7: LOW LIMIT

## C: TRIGger MENU

1: READ HOLD > 2: TRIG DELAY > 3: N SAMPLES

## D: SYStem MENU

1: RDGS STORE > 2: SAVED RDGS > 3: ERROR > 4: TEST > 5: DISPLAY > 6: BEEP > 7: COMMA > 8: REVISION

## E: Input / Output MENU

1: GPIB ADDR > 2: INTERFACE > 3: BAUD RATE > 4: PARITY > 5: LANGUAGE

## F: CALibration MENU\*

1: SECURED > [ 1: UNSECURED ] > [ 2: CALIBRATE ] > 3: CAL COUNT > 4: MESSAGE

\* The commands enclosed in square brackets ( [ ] ) are “hidden” unless the multimeter is UNSECURED for calibration.

# Display Annunciators

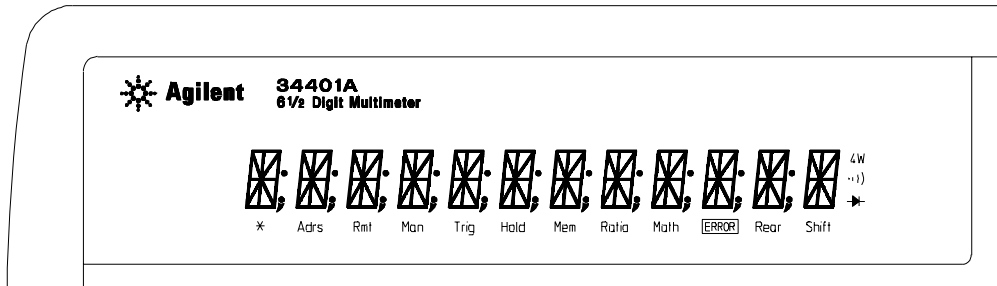

*	Turns on during a measurement.
<b>Adrs</b>	Multimeter is addressed to listen or talk over the GPIB interface.
<b>Rmt</b>	Multimeter is in remote mode (remote interface).
<b>Man</b>	Multimeter is using manual ranging (autorange is disabled).
<b>Trig</b>	Multimeter is waiting for a single trigger or external trigger.
<b>Hold</b>	Reading Hold is enabled.
<b>Mem</b>	Turns on when reading memory is enabled.
<b>Ratio</b>	Multimeter is in dcv:dcv ratio function.
<b>Math</b>	A math operation is enabled (null, min-max, dB, dBm, or limit test).
<b>ERROR</b>	Hardware or remote interface command errors are detected.
<b>Rear</b>	Rear input terminals are selected.
<b>Shift</b>	"Shift" key has been pressed. <i>Press "Shift" again to turn off.</i>
....)	Multimeter is in 4-wire ohms function.
..))	Multimeter is in continuity test function.
→	Multimeter is in diode test function.

To review the display annunciators, hold down the Shift key as you turn on the multimeter.

---

## The Rear Panel at a Glance

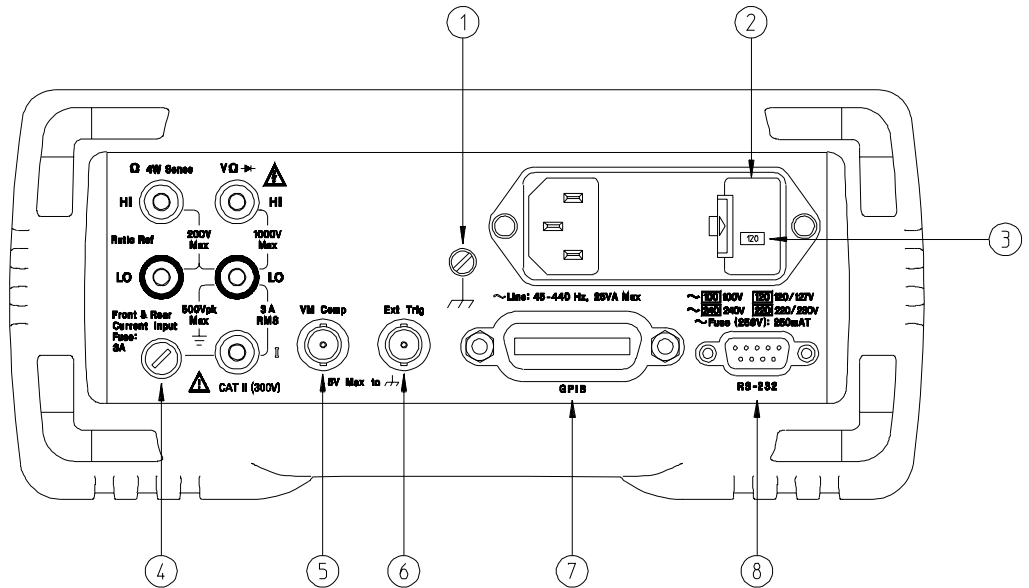

- 
- |                                     |                                       |
|-------------------------------------|---------------------------------------|
| 1 Chassis Ground                    | 5 Voltmeter Complete Output Terminal  |
| 2 Power-Line Fuse-Holder Assembly   | 6 External Trigger Input Terminal     |
| 3 Power-Line Voltage Setting        | 7 GPIB (IEEE-488) Interface connector |
| 4 Front and Rear Current Input Fuse | 8 RS-232 interface connector          |

### Use the front-panel Input / Output Menu to:

- Select the GPIB or RS-232 interface (see chapter 4).
- Set the GPIB bus address (see chapter 4).
- Set the RS-232 baud rate and parity (see chapter 4).

---

# In This Book

**Quick Start** Chapter 1 prepares the multimeter for use and helps you get familiar with a few of its front-panel features.

**Front-Panel Menu Operation** Chapter 2 introduces you to the front-panel menu and describes some of the multimeter's menu features.

**Features and Functions** Chapter 3 gives a detailed description of the multimeter's capabilities and operation. You will find this chapter useful whether you are operating the multimeter from the front panel or over the remote interface.

**Remote Interface Reference** Chapter 4 contains reference information to help you program the multimeter over the remote interface.

**Error Messages** Chapter 5 lists the error messages that may appear as you are working with the multimeter. Each listing contains enough information to help you diagnose and solve the problem.

**Application Programs** Chapter 6 contains several remote interface application programs to help you develop programs for your measurement application.

**Measurement Tutorial** Chapter 7 discusses measurement considerations and techniques to help you obtain the best accuracies and reduce sources of measurement error.

**Specifications** Chapter 8 lists the multimeter's specifications and describes how to interpret these specifications.

*If you have questions relating to the operation of the Agilent 34401A, call **1-800-452-4844** in the United States, or contact your nearest Agilent Sales Office.*

*If your 34401A fails within one year of purchase, Agilent will repair or replace it free of charge. Call **1-877-444-7278** ("Agilent Express") in the United States, or contact your nearest Agilent Sales Office.*

---

# Contents

## **Chapter 1 Quick Start**

To Prepare the Multimeter for Use	13
If the Multimeter Does Not Turn On	14
To Adjust the Carrying Handle	16
To Measure Voltage	17
To Measure Resistance	17
To Measure Current	18
To Measure Frequency (or Period)	18
To Test Continuity	19
To Check Diodes	19
To Select a Range	20
To Set the Resolution	21
Front-Panel Display Formats	22
To Rack Mount the Multimeter	23

## **Chapter 2 Front-Panel Menu Operation**

Front-Panel Menu Reference	27
A Front-Panel Menu Tutorial	29
To Turn Off the Comma Separator	37
To Make Null (Relative) Measurements	38
To Store Minimum and Maximum Readings	39
To Make dB Measurements	40
To Make dBm Measurements	41
To Trigger the Multimeter	42
To Use Reading Hold	43
To Make dcv:dcv Ratio Measurements	44
To Use Reading Memory	46

## **Chapter 3 Features and Functions**

### *Measurement Configuration*

AC Signal Filter	51
Continuity Threshold Resistance	52
DC Input Resistance	53
Resolution	54
Integration Time	57
Front / Rear Input Terminal Switching	58
Autozero	59
Ranging	60

**Chapter 3 Features and Functions** *(continued)*

*Math Operations*

- Min-Max Operation 64
- Null (Relative) Operation 65
- dB Measurements 67
- dBm Measurements 68
- Limit Testing 69

*Triggering*

- Trigger Source Choices 73
- The Wait-for-Trigger State 76
- Halting a Measurement in Progress 76
- Number of Samples 77
- Number of Triggers 78
- Trigger Delay 79
- Automatic Trigger Delays 81
- Reading Hold 82
- Voltmeter Complete Terminal 83
- External Trigger Terminal 83

*System-Related Operations*

- Reading Memory 84
- Error Conditions 85
- Self-Test 86
- Display Control 87
- Beeper Control 88
- Comma Separators 89
- Firmware Revision Query 89
- SCPI Language Version Query 90

*Remote Interface Configuration*

- GPIB Address 91
- Remote Interface Selection 92
- Baud Rate Selection (RS-232) 93
- Parity Selection (RS-232) 93
- Programming Language Selection 94

*Calibration*

- Calibration Security 95
- Calibration Count 98
- Calibration Message 99

*Operator Maintenance*

- To Replace the Power-Line Fuse 100
- To Replace the Current Input Fuses 100

*Power-On and Reset State* 101

## **Chapter 4 Remote Interface Reference**

Command Summary	105
Simplified Programming Overview	112
The MEASure? and CONFigure Commands	117
Measurement Configuration Commands	121
Math Operation Commands	124
Triggering	127
Triggering Commands	130
System-Related Commands	132
The SCPI Status Model	134
Status Reporting Commands	144
Calibration Commands	146
RS-232 Interface Configuration	148
RS-232 Interface Commands	153
An Introduction to the SCPI Language	154
Output Data Formats	159
Using Device Clear to Halt Measurements	160
TALK ONLY for Printers	160
To Set the GPIB Address	161
To Select the Remote Interface	162
To Set the Baud Rate	163
To Set the Parity	164
To Select the Programming Language	165
Alternate Programming Language Compatibility	166
SCPI Compliance Information	168
IEEE-488 Compliance Information	169

## **Chapter 5 Error Messages**

Execution Errors	173
Self-Test Errors	179
Calibration Errors	180

## **Chapter 6 Application Programs**

Using MEASure? for a Single Measurement	185
Using CONFigure with a Math Operation	186
Using the Status Registers	188
RS-232 Operation Using QuickBASIC	192
RS-232 Operation Using Turbo C	193

## Chapter 7 Measurement Tutorial

Thermal EMF Errors	199
Loading Errors (dc volts)	199
Leakage Current Errors	199
Rejecting Power-Line Noise Voltages	200
Common Mode Rejection (CMR)	201
Noise Caused by Magnetic Loops	201
Noise Caused by Ground Loops	202
Resistance Measurements	203
4-Wire Ohms Measurements	203
Removing Test Lead Resistance Errors	204
Power Dissipation Effects	204
Settling Time Effects	204
Errors in High Resistance Measurements	205
DC Current Measurement Errors	205
True RMS AC Measurements	206
Crest Factor Errors	207
Loading Errors (ac volts)	209
Measurements Below Full Scale	210
High-Voltage Self-Heating Errors	210
Temperature Coefficient and Overload Errors	210
Low-Level Measurement Errors	211
Common Mode Errors	212
AC Current Measurement Errors	212
Frequency and Period Measurement Errors	213
Making High-Speed DC and Resistance Measurements	213
Making High-Speed AC Measurements	214

## Chapter 8 Specifications

DC Characteristics	216
AC Characteristics	218
Frequency and Period Characteristics	220
General Information	222
Product Dimensions	223
To Calculate Total Measurement Error	224
Interpreting Multimeter Specifications	226
Configuring for Highest Accuracy Measurements	229

**Index** 231

**Declaration of Conformity** 237



---

# Quick Start

---

# Quick Start

One of the first things you will want to do with your multimeter is to become acquainted with its front panel. We have written the exercises in this chapter to prepare the multimeter for use and help you get familiar with some of its front-panel operations.

The front panel has two rows of keys to select various functions and operations. Most keys have a *shifted* function printed in *blue* above the key. To perform a shifted function, press **Shift** (the **Shift** annunciator will turn on). Then, press the key that has the desired label above it. For example, to select the dc current function, press **Shift** **DC V** .

If you accidentally press **Shift** , just press it again to turn off the **Shift** annunciator.

*The rear cover of this book is a fold-out Quick Reference Guide. On this cover you will find a quick summary of various multimeter features.*

---

## To Prepare the Multimeter for Use

The following steps help you verify that the multimeter is ready for use.

### 1 Check the list of supplied items.

Verify that you have received the following items with your multimeter. If anything is missing, contact your nearest Agilent Sales Office.

- One test lead kit.
- One power cord.
- This *User's Guide*.
- One *Service Guide*.
- One folded *Quick Reference* card.
- Certificate of Calibration.

### 2 Connect the power cord and turn on the multimeter.

The front-panel display will light up while the multimeter performs its power-on self-test. The GPIB bus address is displayed. Notice that the multimeter powers up in the *dc voltage* function with autoranging enabled.

*To review the power-on display with all annunciators turned on, hold down Shift as you turn on the multimeter.*

### 3 Perform a *complete* self-test.

The *complete* self-test performs a more extensive series of tests than those performed at power-on. Hold down Shift as you press the Power switch to turn on the multimeter; *hold down the key for more than 5 seconds*. The self-test will begin when you release the key.

If the self-test is successful, "PASS" is displayed. If the self-test is not successful, "FAIL" is displayed and the **ERROR** annunciator turns on. See the *Service Guide* for instructions on returning the multimeter to Agilent for service.

---

## If the Multimeter Does Not Turn On

Use the following steps to help solve problems you might encounter when turning on the multimeter. If you need more help, see the *Service Guide* for instructions on returning the multimeter to Agilent for service.

### **1 Verify that there is ac power to the multimeter.**

First, verify that the multimeter's Power switch is in the "On" position. Also, make sure that the power cord is firmly plugged into the power module on the rear panel. You should also make sure that the power source you plugged the multimeter into is energized.

### **2 Verify the power-line voltage setting.**

The line voltage is set to the proper value for your country when the multimeter is shipped from the factory. Change the voltage setting if it is not correct. The settings are: 100, 120, 220, or 240 Vac (for 230 Vac operation, use the 220 Vac setting).

*See the next page if you need to change the line-voltage setting.*

### **3 Verify that the power-line fuse is good.**

The multimeter is shipped from the factory with a 250 mA fuse installed. This is the correct fuse for all line voltages.

*See the next page if you need to replace the power-line fuse.*

*To replace the 250 mA fuse, order Agilent part number 2110-0817.*

**1 Remove the power cord.** Remove the fuse-holder assembly from the rear panel.

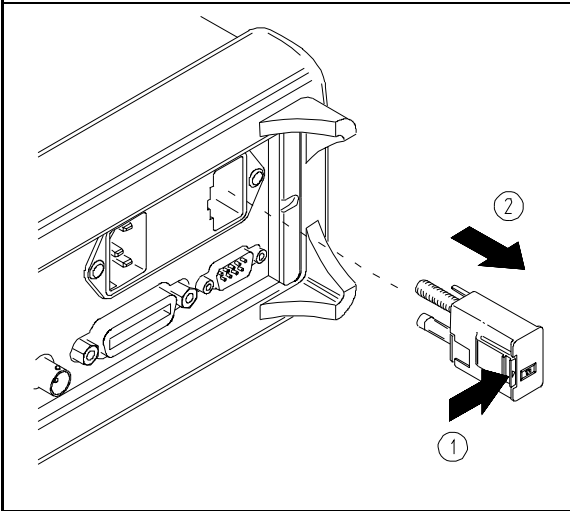

**2 Remove the line-voltage selector** from the assembly.

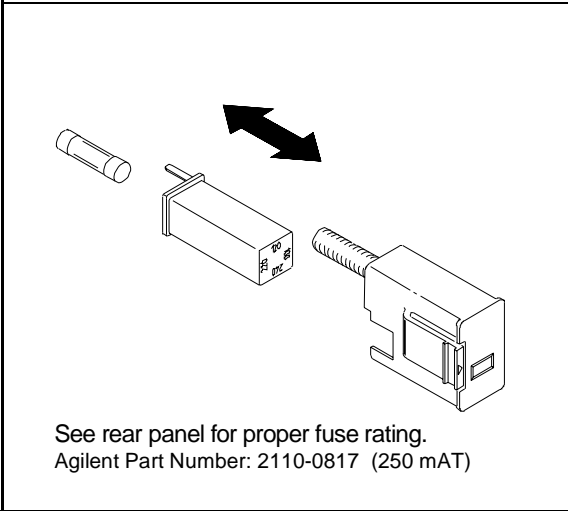

**3 Rotate the line-voltage selector** until the correct voltage appears in the window.

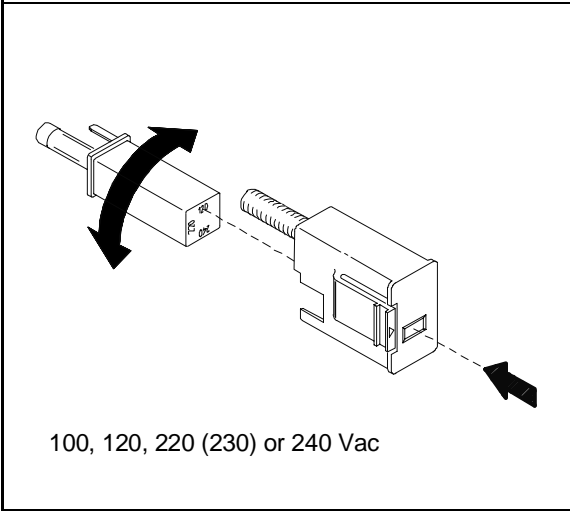

**4 Replace the fuse-holder assembly** in the rear panel.

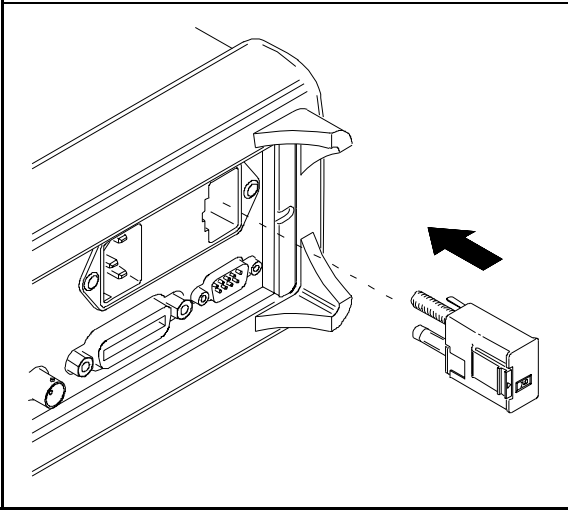

Verify that the correct line voltage is selected and the power-line fuse is good.

---

## To Adjust the Carrying Handle

To adjust the position, grasp the handle by the sides and *pull outward*. Then, rotate the handle to the desired position.

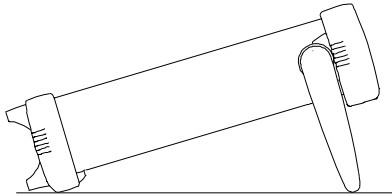
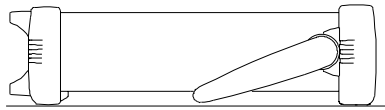

**Bench-top viewing positions**

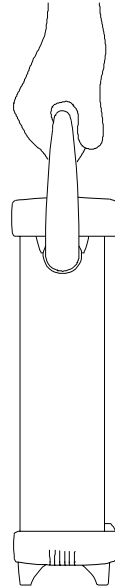

**Carrying position**

## To Measure Voltage

Ranges: 100 mV, 1 V, 10 V, 100 V, 1000 V (750 Vac)

Maximum resolution: 100 nV (on 100 mV range)

AC technique: true RMS, ac-coupled

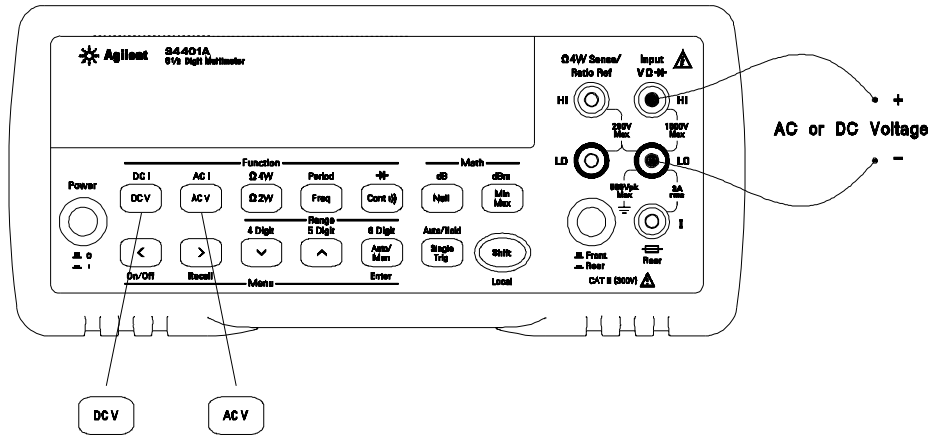

## To Measure Resistance

Ranges: 100 Ω, 1 kΩ, 10 kΩ, 100 kΩ, 1 MΩ, 10 MΩ, 100 MΩ

Maximum resolution: 100 μΩ (on 100 ohm range)

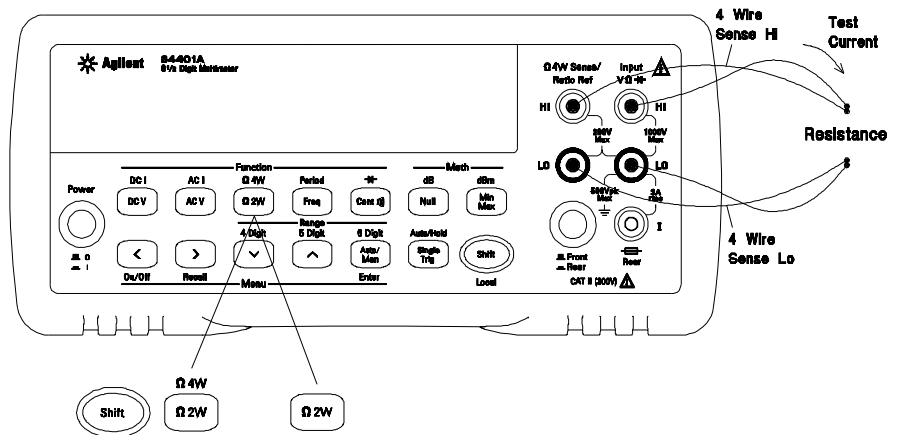

## To Measure Current

Ranges: 10 mA (dc only), 100 mA (dc only), 1 A , 3 A  
Maximum resolution: 10 nA (*on 10 mA range*)  
AC technique: true RMS, ac-coupled

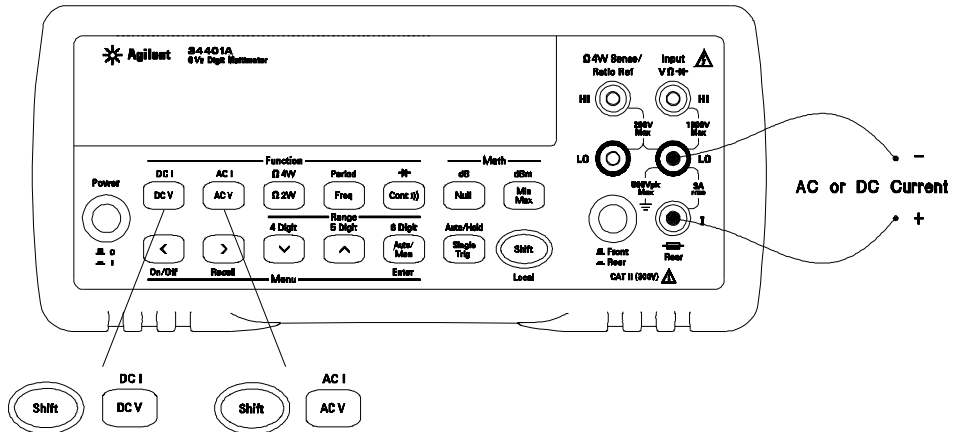

## To Measure Frequency (or Period)

Measurement band: 3 Hz to 300 kHz (0.33 sec to 3.3  $\mu$ sec)  
Input signal range: 100 mVac to 750 Vac  
Technique: reciprocal counting

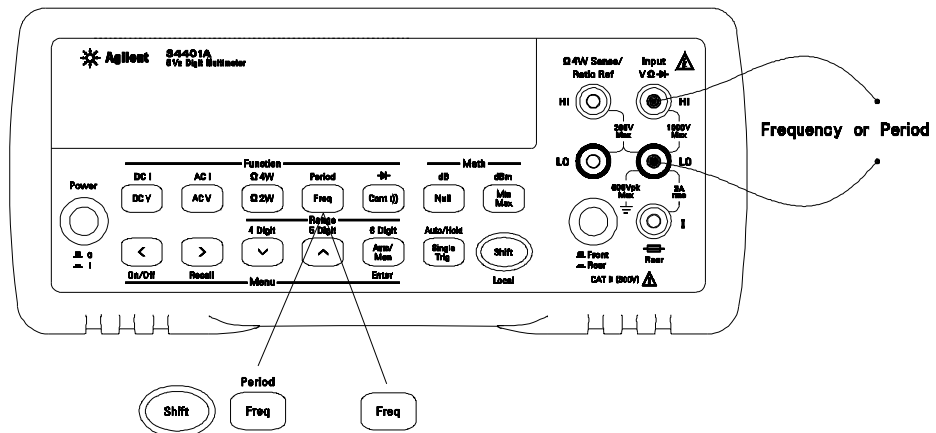



## To Test Continuity

Test current source: 1 mA

Maximum resolution: 0.1  $\Omega$  (range is fixed at 1 kohm)

Beeper threshold: 1  $\Omega$  to 1000  $\Omega$  (beeps below adjustable threshold)

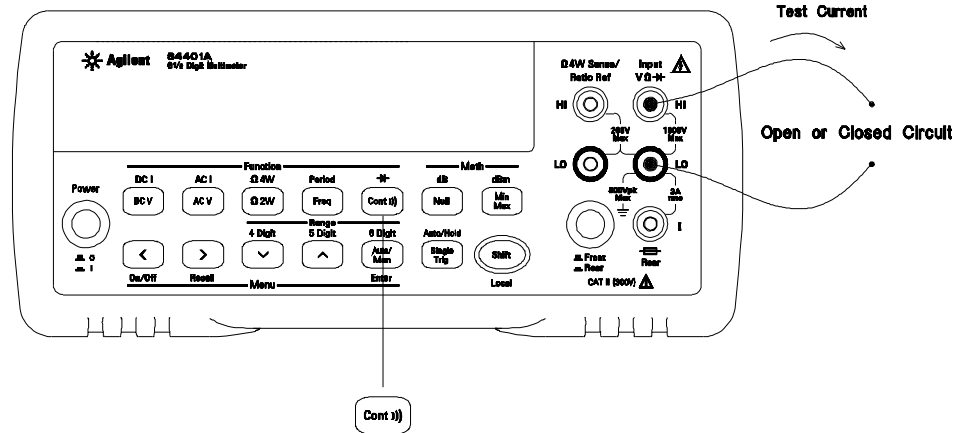

## To Check Diodes

Test current source: 1 mA

Maximum resolution: 100  $\mu\text{V}$  (range is fixed at 1 Vdc)

Beeper threshold: 0.3 volts  $\leq V_{\text{measured}} \leq 0.8$  volts (not adjustable)

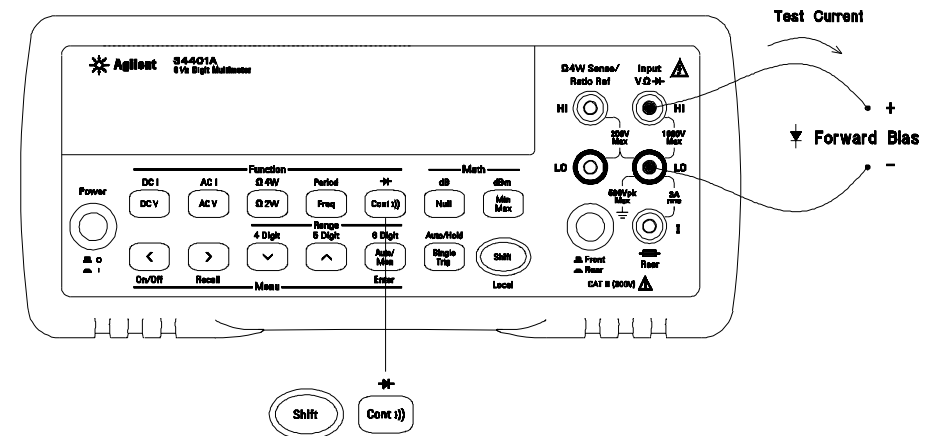

## To Select a Range

You can let the multimeter automatically select the range using *autoranging* or you can select a fixed range using *manual ranging*.

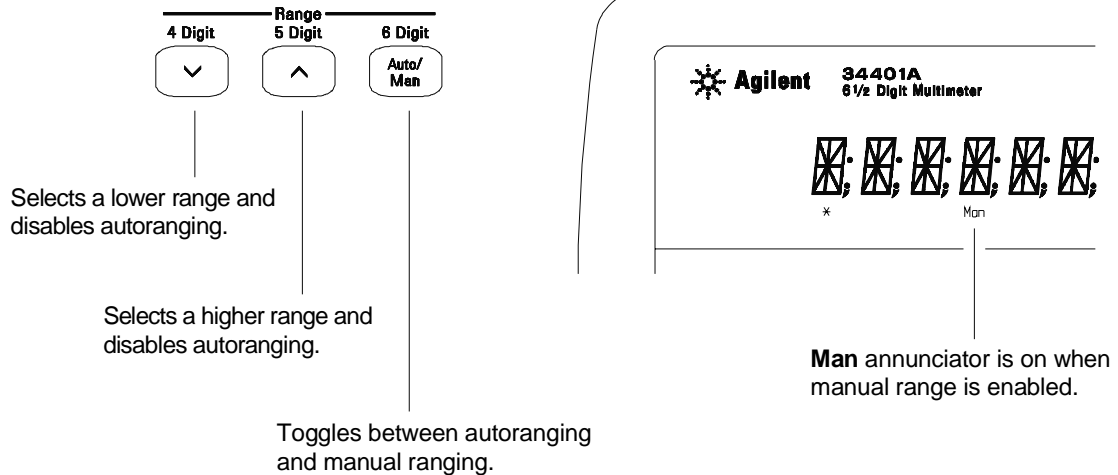

- Autoranging is selected at power-on and after a remote interface reset.
- Autorange thresholds:
  - Down range at <10% of range
  - Up range at >120% of range
- If the input signal is greater than the present range can measure, the multimeter will give an *overload* indication (“OVL”).
- For frequency and period measurements from the front panel, ranging applies to the signal’s input *voltage*, not its frequency.
- The range is fixed for continuity (1 k $\Omega$  range) and diode (1 Vdc range).

*Ranging is local to the selected function. This means that you can select the ranging method (auto or manual) for each function independently. When manually ranging, the selected range is local to the function; the multimeter remembers the range when you switch between functions.*

## To Set the Resolution

You can set the display resolution to 4<sup>1</sup>/<sub>2</sub>, 5<sup>1</sup>/<sub>2</sub>, or 6<sup>1</sup>/<sub>2</sub> digits either to optimize measurement speed or noise rejection. In this book, the most significant digit (leftmost on the display) is referred to as the “<sup>1</sup>/<sub>2</sub>” digit, since it can only be a “0” or “1.”

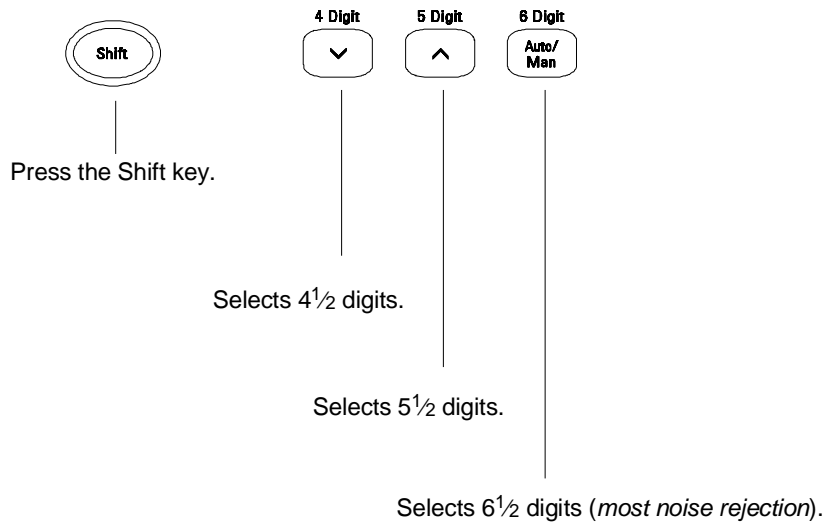

- The resolution is set to 5<sup>1</sup>/<sub>2</sub> digits at power-on and after a remote interface reset.
- The resolution is fixed at 5<sup>1</sup>/<sub>2</sub> digits for continuity and diode tests.
- You can also vary the number of digits displayed using the arrow keys (however, the integration time is not changed).

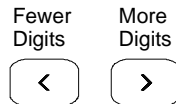

*Resolution is local to the selected function. This means that you can select the resolution for each function independently. The multimeter remembers the resolution when you switch between functions.*

---

## Front-Panel Display Formats

-H.DDD,DDD EFFF

**Front-panel display format.**

- Negative sign or blank (positive)
- H "1/2" digit (0 or 1)
- D Numeric digits
- E Exponent ( m, k, M )
- F Measurement units ( VDC, OHM, HZ, dB )

5 digits

"1/2" digit

10.216,5 VDC

**This is the 10 Vdc range, 5<sup>1/2</sup> digits are displayed.**

"1/2" digit

-045.23 mVDC

**This is the 100 mVdc range, 4<sup>1/2</sup> digits are displayed.**

113.325,6 OHM

**This is the 100 ohm range, 6<sup>1/2</sup> digits are displayed.**

OVL.D mVDC

**This is an overload indication on the 100 mVdc range.**

---

## To Rack Mount the Multimeter

You can mount the multimeter in a standard 19-inch rack cabinet using one of three optional kits available. Instructions and mounting hardware are included with each rack-mounting kit. Any Agilent *System II* instrument of the same size can be rack-mounted beside the 34401A.

*Remove the carrying handle, and the front and rear rubber bumpers, before rack-mounting the multimeter.*

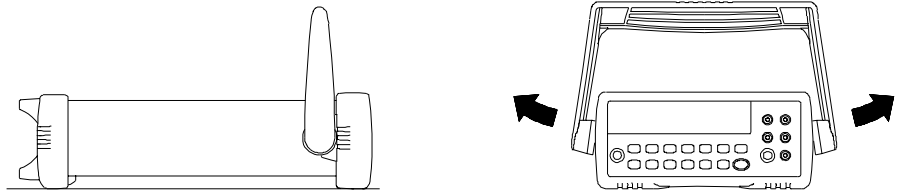

**To remove the handle, rotate it to the vertical position and pull the ends outward.**

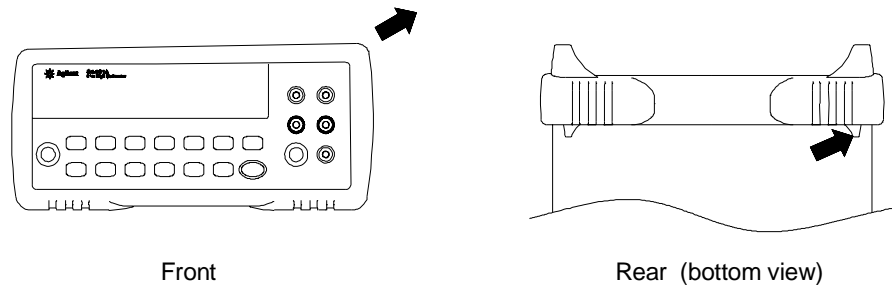

**To remove the rubber bumper, stretch a corner and then slide it off.**

Chapter 1 Quick Start  
**To Rack Mount the Multimeter**

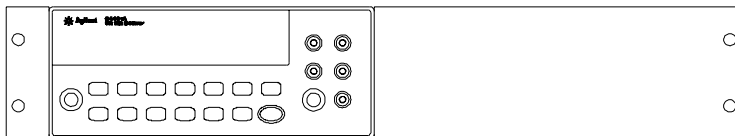

**To rack mount a single instrument, order adapter kit 5063-9240.**

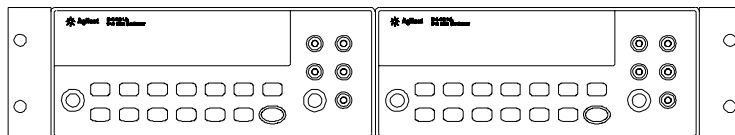

**To rack mount two instruments side-by-side, order lock-link kit 5061-9694 and flange kit 5063-9212.**

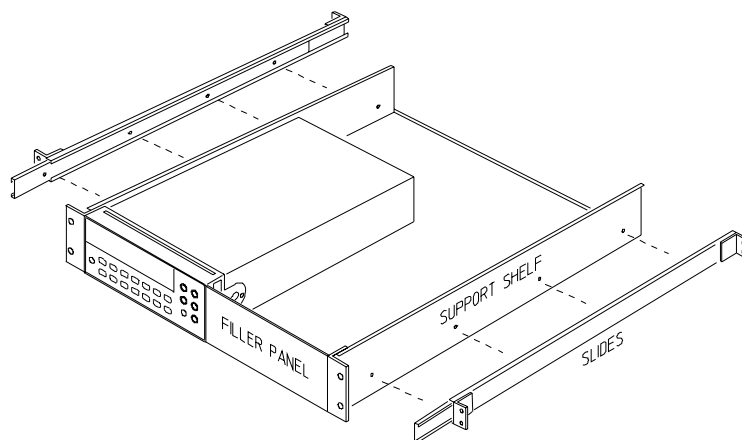

**To install one or two instruments in a sliding support shelf, order shelf 5063-9255, and slide kit 1494-0015 (for a single instrument, also order filler panel 5002-3999).**

---

## Front-Panel Menu Operation

---

# Front-Panel Menu Operation

By now you should be familiar with the FUNCTION and RANGE / DIGITS groups of front-panel keys. You should also understand how to make front-panel connections for the various types of measurements. If you are not familiar with this information, we recommend that you read chapter 1, “Quick Start,” starting on page 11.

This chapter introduces you to three new groups of front-panel keys: MENU, MATH, and TRIG. You will also learn how to use the comma separator and store readings in memory. This chapter *does not* give a detailed description of *every* front-panel key or menu operation. It does, however, give you a good overview of the front-panel menu and many front-panel operations. See chapter 3 “Features and Functions,” starting on page 49, for a complete discussion of the multimeter’s capabilities and operation.



---

## Front-Panel Menu Reference

### A: MEASurement MENU

1: AC FILTER > 2: CONTINUITY > 3: INPUT R > 4: RATIO FUNC > 5: RESOLUTION

<b>1: AC FILTER</b>	Selects the slow, medium, or fast ac filter.
<b>2: CONTINUITY</b>	Sets the continuity beeper threshold (1 $\Omega$ to 1000 $\Omega$ ).
<b>3: INPUT R</b>	Sets the input resistance for dc voltage measurements.
<b>4: RATIO FUNC</b>	Enables the dcv:dcv ratio function.
<b>5: RESOLUTION</b>	Selects the measurement resolution.

### B: MATH MENU

1: MIN-MAX > 2: NULL VALUE > 3: dB REL > 4: dBm REF R > 5: LIMIT TEST > 6: HIGH LIMIT > 7: LOW LIMIT

<b>1: MIN-MAX</b>	Recalls the stored minimum, maximum, average, and reading count.
<b>2: NULL VALUE</b>	Recalls or sets the null value stored in the null register.
<b>3: dB REL</b>	Recalls or sets the dBm value stored in the dB relative register.
<b>4: dBm REF R</b>	Selects the dBm reference resistance value.
<b>5: LIMIT TEST</b>	Enables or disables limit testing.
<b>6: HIGH LIMIT</b>	Sets the upper limit for limit testing.
<b>7: LOW LIMIT</b>	Sets the lower limit for limit testing.

### C: TRIGger MENU

1: READ HOLD > 2: TRIG DELAY > 3: N SAMPLES

<b>1: READ HOLD</b>	Sets the reading hold sensitivity band.
<b>2: TRIG DELAY</b>	Specifies a time interval which is inserted before a measurement.
<b>3: N SAMPLES</b>	Sets the number of samples per trigger.

## Chapter 2 Front-Panel Menu Operation

### Front-Panel Menu Reference

#### D: SYStem MENU

1: RDGS STORE > 2: SAVED RDGS > 3: ERROR > 4: TEST > 5: DISPLAY > 6: BEEP > 7: COMMA > 8: REVISION

1: <b>RDGS STORE</b>	Enables or disables reading memory.
2: <b>SAVED RDGS</b>	Recalls readings stored in memory (up to 512 readings).
3: <b>ERROR</b>	Retrieves errors from the error queue (up to 20 errors).
4: <b>TEST</b>	Performs a complete self-test.
5: <b>DISPLAY</b>	Enables or disables the front-panel display.
6: <b>BEEP</b>	Enables or disables the beeper function.
7: <b>COMMA</b>	Enables or disables a comma separator between digits on the display.
8: <b>REVISION</b>	Displays the multimeter's firmware revision codes.

#### E: Input / Output MENU

1: GPIB ADDR > 2: INTERFACE > 3: BAUD RATE > 4: PARITY > 5: LANGUAGE

1: <b>HP-IB ADDR</b>	Sets the GPIB bus address (0 to 31).
2: <b>INTERFACE</b>	Selects the GPIB or RS-232 interface.
3: <b>BAUD RATE</b>	Selects the baud rate for RS-232 operation.
4: <b>PARITY</b>	Selects even, odd, or no parity for RS-232 operation.
5: <b>LANGUAGE</b>	Selects the interface language: SCPI, Agilent 3478, or Fluke 8840/42.

#### F: CALibration MENU\*

1: SECURED > [ 1: UNSECURED ] > [ 2: CALIBRATE ] > 3: CAL COUNT > 4: MESSAGE

1: <b>SECURED</b>	The multimeter is secured against calibration; enter code to unsecure.
1: <b>UNSECURED</b>	The multimeter is unsecured for calibration; enter code to secure.
2: <b>CALIBRATE</b>	Performs complete calibration of present function; must be UNSECURED.
3: <b>CAL COUNT</b>	Reads the total number of times the multimeter has been calibrated.
4: <b>MESSAGE</b>	Reads the calibration string (up to 12 characters) entered from remote.

\* The commands enclosed in square brackets ( [ ] ) are "hidden" unless the multimeter is UNSECURED for calibration.

## A Front-Panel Menu Tutorial

This section is a step-by-step tutorial which shows how to use the front-panel menu. We recommend that you spend a few minutes with this tutorial to get comfortable with the structure and operation of the menu.

The menu is organized in a top-down tree structure with three levels (*menus*, *commands*, and *parameters*). You move down  or up  the menu tree to get from one *level* to the next. Each of the three levels has several horizontal *choices* which you can view by moving left  or right .

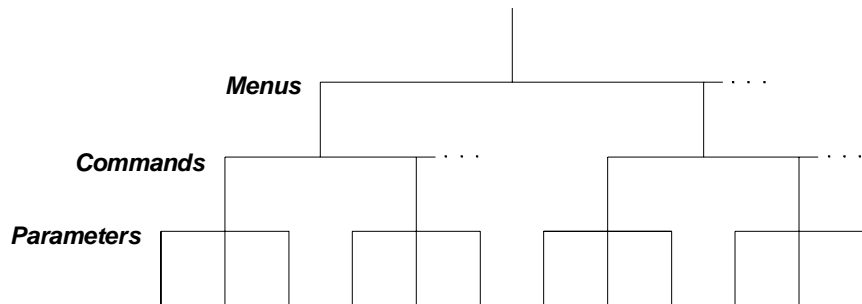

- To *turn on* the menu, press     .
- To *turn off* the menu, press     , or press any of the function or math keys on the top row of front-panel keys.
- To *execute* a menu command, press   .
- To *recall* the last menu command that was executed, press     .

## A Front-Panel Menu Tutorial

### MESSAGES DISPLAYED DURING MENU USE

**TOP OF MENU** You pressed  while on the “menus” level; this is the top level of the menu and you cannot go any higher.

To turn off the menu, press   (Menu On/Off). To move across the choices on a level, press  or . To move down a level, press .

**MENUS** You are on the “menus” level. Press  or  to view the choices.

**COMMANDS** You are on the “commands” level. Press  or  to view the command choices within the selected menu group.

**PARAMETER** You are on the “parameter” level. Press  or  to view and edit the parameter for the selected command.

**MENU BOTTOM** You pressed  while on the “parameter” level; this is the bottom level of the menu and you cannot go any lower.

To turn off the menu, press   (Menu On/Off). To move up a level, press .

**CHANGE SAVED** The change made on the “parameter” level is saved. This is displayed after you press  (Menu Enter) to execute the command.

**MIN VALUE** The value you specified on the “parameter” level is too small for the selected command. The minimum value allowed is displayed for you to edit.

**MAX VALUE** The value you specified on the “parameter” level is too large for the selected command. The maximum value allowed is displayed for you to edit.

**EXITING MENU** You will see this message if you turn off the menu by pressing   (Menu On/Off) or a front-panel function/math key. You did not edit any values on the “parameter” level and changes were NOT saved.

**NOT ENTERED** You will see this message if you turn off the menu by pressing   (Menu On/Off) or a front-panel function/math key. You did some editing of parameters but the changes were NOT saved. Press  (Menu Enter) to save changes made on the “parameter” level.

**NOT RELEVANT** The selected math operation is NOT valid for the function in use.

---

**Menu Example 1**

The following steps show you how to turn on the menu, move up or down between levels, move across the choices on each level, and turn off the menu. In this example, you will turn off the front-panel beeper.

On/Off  
Shift <

**1 Turn on the menu.**

You enter the menu on the “menus” level. The MEAS MENU is your first choice on this level.

A: MEAS MENU

> > >

**2 Move across to the SYS MENU choice on this level.**

There are six menu group choices available on the “menus” level. Each choice has a letter prefix for easy identification (A: , B: , etc.).

D: SYS MENU

∨

**3 Move down to the “commands” level within the SYS MENU.**

The RDGS STORE command is your first choice on this level.

1: RDGS STORE

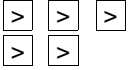

**4 Move across to the BEEP command on the “commands” level.**

There are eight command choices available in the SYS MENU. Each choice on this level has a number prefix for easy identification (1: , 2: , etc.).



**5 Move down a level to the BEEP parameter choices.**

The first parameter choice is “ON” for the BEEP command (the beeper setting is stored in non-volatile memory and “ON” is the factory setting).



**6 Move across to the “OFF” choice.**

There are two parameter choices for BEEP.



**7 Save the change and turn off the menu.**

The multimeter beeps and displays a message to show that the change is now in effect. You are then exited from the menu.



**Menu Example 2**

The following exercise demonstrates how to use the *menu recall* feature as a shortcut to set the BEEP command back to its original setting. *You must perform the steps in Example 1 before you start this example.*

Shift > Recall

**1 Use menu recall to return to the BEEP command.**

This returns you to the BEEP command, which was the last command used before you exited the menu in the Example 1.

6 : BEEP

v

**2 Move down to the BEEP parameter choices.**

The first parameter choice is “OFF” (the current setting from Example 1).

OFF

>

**3 Move across to the “ON” choice.**

Set the parameter back to its original value.

ON

Auto/Man  
ENTER

**4 Save the change and turn off the menu.**

The multimeter beeps and displays a message to show that the change is now in effect. You are then exited from the menu.

CHANGE SAVED

---

**Menu Example 3**

Some commands in the menu require that you enter a numeric parameter value. The following steps show you how to enter a number in the menu. For this example, you will set the null value to  $-2.0$  volts.

*Make sure the multimeter is in the dc voltage function with  $5^{1/2}$  digits of resolution displayed. Disconnect all inputs to the multimeter.*

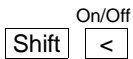

**1 Turn on the menu.**

You enter the menu on the “menus” level. The MEAS MENU is your first choice on this level.



**2 Move across to the MATH MENU choice on this level.**

There are six menu group choices available on this level.

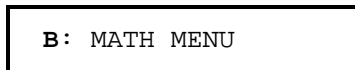

**3 Move down to the “commands” level within the MATH MENU.**

The MIN-MAX command is your first choice on this level.

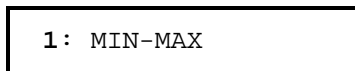

**4 Move across to the NULL VALUE command on this level.**

There are seven command choices available within the MATH MENU.







**5 Move down to edit the NULL VALUE parameter.**

The null value should be 0.0 Vdc when you come to this point in the menu for the first time. For this example, you will set the null value to -2.0 volts.

^000.000 mVDC

*When you see the flashing “^” on the left side of the display, you can abort the edit and return to the “commands” level by pressing .*



**6 Make the number negative.**

The leftmost character on the display toggles between + and - .

-000.000 mVDC



**7 Move the flashing cursor over to edit the first digit.**

Notice that the leftmost digit is flashing.

-000.000 mVDC



**8 Increment the first digit until “2” is displayed.**

You decrement or increment each digit independently. Neighboring digits are not affected.

-200.000 mVDC



**9 Move the flashing cursor over to the “units” location.**

Notice that the units are flashing on the right side of the display.

-200.000 mVDC



**10 Increase the displayed number by a factor of 10.**

Notice that the position of the decimal point changes and the displayed number increases by a factor of 10.

-2.000,00 VDC



**11 Save the change and turn off the menu.**

The multimeter beeps and displays a message to show that the change is now in effect. You are then exited from the menu.

CHANGE SAVED

*Keep in mind that math null is turned on and  $-2.0$  volts is used as the null value for measurements. To clear the null value, press **Null** .*

*This is the end of the front-panel menu tutorial. The remainder of the chapter discusses several of the most common front-panel operations.*

**To Turn Off the Comma Separator****To Turn Off the Comma Separator**

The multimeter can display readings on the front panel with or without a comma separator. The following steps show how to disable the comma.

08.241,53 VDC

**With comma separator** (*factory setting*)

08.24153 VDC

**Without comma separator**

On/Off  
Shift <

**1 Turn on the menu.**

A: MEAS MENU

> > >

**2 Move across to the SYS MENU choice on the “menus” level.**

D: SYS MENU

∨ < <

**3 Move down a level and then across to the COMMA command.**

7: COMMA

∨ >

**4 Move down a level and then move across to the “OFF” choice.**

OFF

Auto/Man  
ENTER

**5 Save the change and turn off the menu.**

The comma separator setting is stored in *non-volatile* memory, and *does not* change when power has been off or after a remote interface reset.

---

## To Make Null (Relative) Measurements

Each null measurement, also called *relative*, is the difference between a stored null value and the input signal.

**Result** = reading - null value

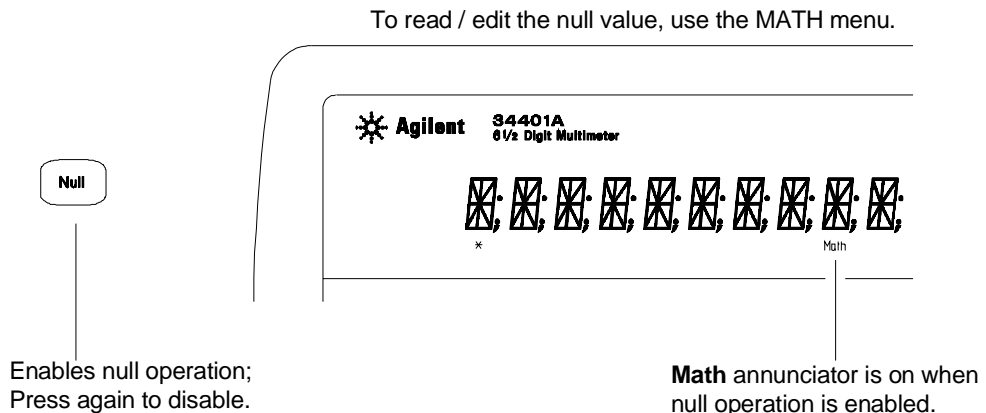

- You can make null measurements with any function except continuity, diode, or ratio. The null operation is local to the selected function; when you change functions, null is disabled.
- To null the test lead resistance for more accurate two-wire ohms measurements, short the ends of the test leads together and then press **Null**.
- The first reading taken after you press **Null** is stored as the null value in the Null Register. Any previously stored value is replaced with the new value.
- After enabling null, you can edit the stored null value by pressing **Shift** **>** (Menu Recall). This takes you to the "NULL VALUE" command in the MATH MENU (*only if null is enabled*). Go down to the "parameter" level, and then edit the displayed value.
- The null register is cleared when you change functions, turn null off, turn off the power, or perform a remote interface reset.

## To Store Minimum and Maximum Readings

You can store the minimum and maximum readings during a series of measurements. The following discussion shows how to read the minimum, maximum, average, and reading count.

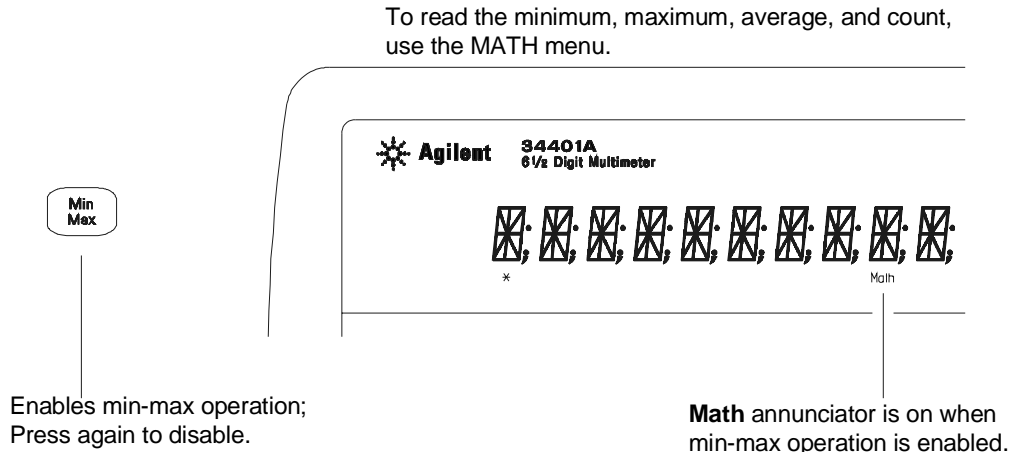

- You can use min-max with any function except continuity or diode test. The min-max operation is local to the selected function; when you change functions, min-max is disabled.
- After enabling min-max, you can read the stored minimum, maximum, average, and count by pressing **[Shift] >** (Menu Recall). This takes you to the "MIN-MAX" command in the MATH MENU (*only if min-max is enabled*). Go down to the "parameter" level, and then read the values by pressing **<** or **>**.
- The stored values are cleared when you turn min-max off, turn off the power, or perform a remote interface reset.
- The average is of all readings taken since min-max was enabled (not just the average of the stored minimum and maximum). The count is the total number of readings taken since min-max was enabled.

---

## To Make dB Measurements

Each dB measurement is the difference between the input signal and a stored relative value, with both values converted to dBm.

$$dB = \text{reading in dBm} - \text{relative value in dBm}$$

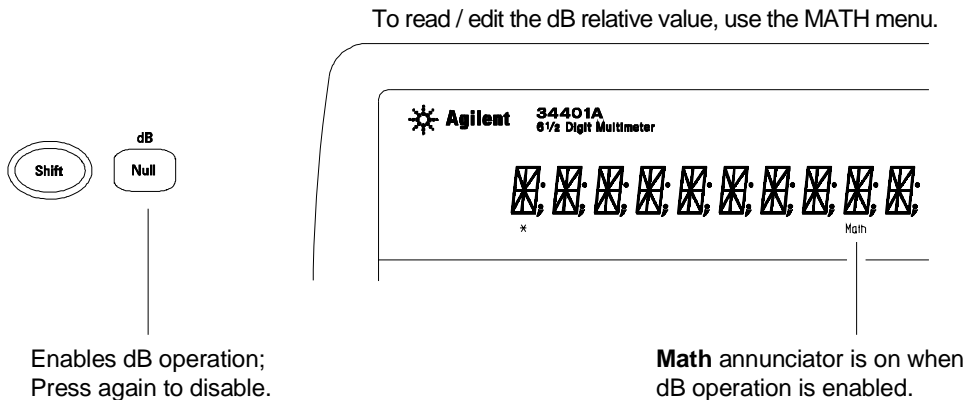

- Select **DC V** or **AC V** .
- The first reading taken after you enable dB measurements is converted to dBm and is stored as the relative value in the dB Relative Register. Any previously stored value is replaced with the new value.
- After enabling dB operations, you can edit the relative value by pressing **Shift** **>** (Menu Recall). This takes you to the “dB REL” command in the MATH MENU (*only if dB is enabled*). Go down to the “parameter” level, and then edit the value displayed.
- The register is cleared when you change functions, turn dB off, turn off the power, or perform a remote interface reset.

## To Make dBm Measurements

The dBm operation calculates the power delivered to a resistance referenced to 1 milliwatt.

$$dBm = 10 \times \text{Log}_{10} ( \text{reading}^2 / \text{reference resistance} / 1 \text{ mW} )$$

To read / edit the dBm reference resistance, use the MATH menu.

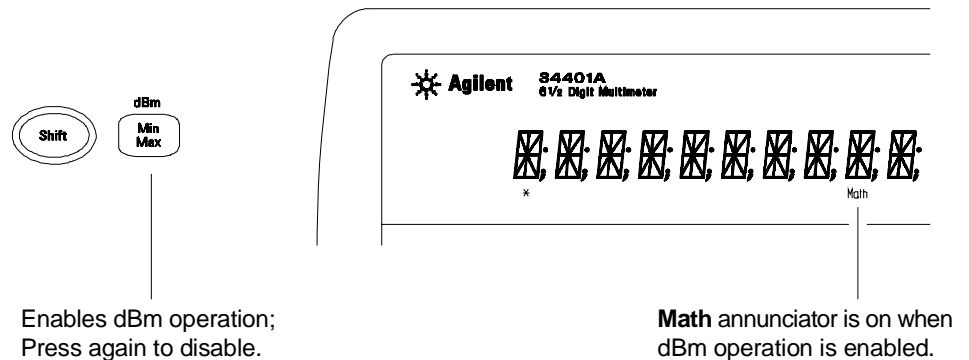

- Select  or .
- The factory setting for the reference resistance is 600 Ω. To select a different value, press   (Menu Recall) after enabling dBm operations. This takes you to the “dBm REF R” command in the MATH MENU (*only if dBm is enabled*).

Go down to the “parameter” level, and then select a value: 50, 75, 93, 110, 124, 125, 135, 150, 250, 300, 500, **600**, 800, 900, 1000, 1200, or 8000 ohms.

- The reference resistance is stored in *non-volatile* memory, and *does not* change when power has been off or after a remote interface reset.

## To Trigger the Multimeter

You can trigger the multimeter from the front panel using *single trigger* or *auto trigger*.

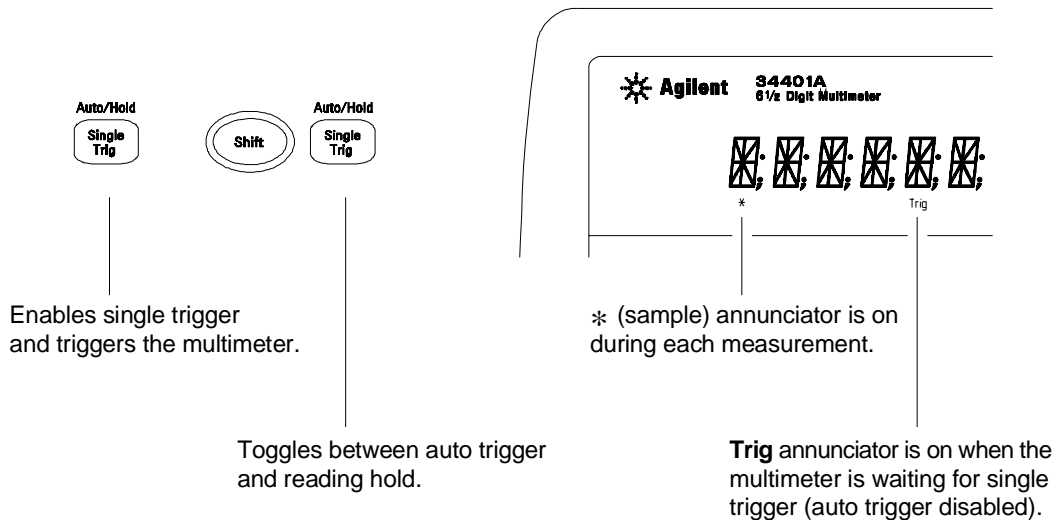

- Auto triggering is enabled when you turn on the multimeter. Notice that the \* (sample) annunciator turns on during each measurement.
- Single triggering takes one reading each time you press **Single** and then waits for the next trigger. Continue pressing this key to trigger the multimeter.

### Using an External Trigger

The external trigger mode is also enabled by pressing **Single**. It is like the single trigger mode except that you apply a trigger pulse to the rear-panel Ext Trig terminal. The multimeter is triggered on the negative edge of a TTL pulse.

The front-panel **Single** key is disabled when in remote.



## To Use Reading Hold

## To Use Reading Hold

The reading hold feature allows you to capture and hold a stable reading on the display. When a stable reading is detected, the multimeter emits a beep and holds the value on the display.

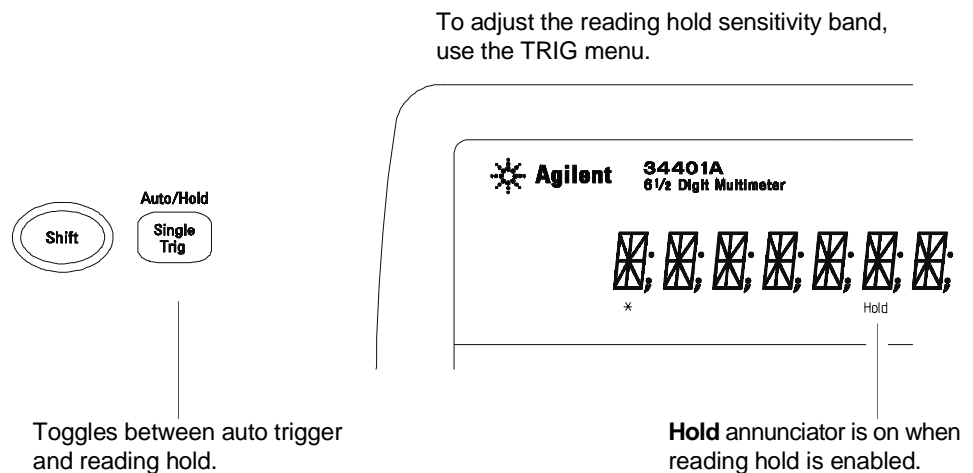

- Reading hold has an adjustable *sensitivity band* to allow you to select which readings are considered stable enough to be displayed. The band is expressed as a percent of reading on the selected range. The multimeter will capture and display a new value only after *three* consecutive readings are within the band.
- The default band is 0.10% of reading. After enabling reading hold, you can choose a different band by pressing   (Menu Recall). This takes you to the “READ HOLD” command in the TRIG MENU (*only if reading hold is enabled*).

Go down to the “parameter” level, and then select a value:  
0.01%, **0.10%**, 1.00%, or 10.00% of reading.

- The sensitivity band is stored in *volatile* memory; the multimeter sets the band to 0.10% of reading when power has been off or after a remote interface reset.

## To Make dcv:dcv Ratio Measurements

To calculate a ratio, the multimeter measures a dc reference voltage applied to the **Sense** terminals and the voltage applied to the **Input** terminals.

$$\text{Ratio} = \frac{\text{dc signal voltage}}{\text{dc reference voltage}}$$

To enable ratio measurements, use the MEAS menu.

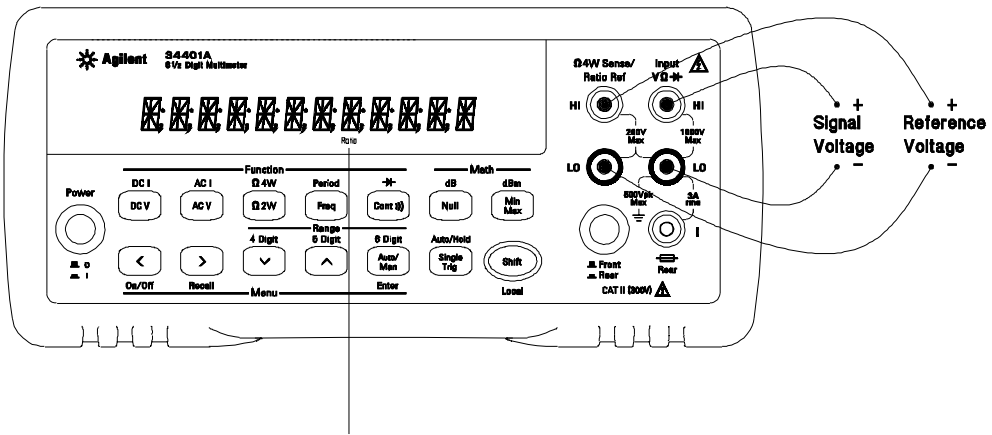

**Ratio** annunciator is on when ratio measurements are enabled.

- At the **Sense** terminals, the reference voltage measurement function is always *dc voltage* and has a maximum measurable input of  $\pm 12$  Vdc. Autoranging is automatically selected for reference voltage measurements on the **Sense** terminals.
- The **Input** LO and **Sense** LO terminals must have a common reference and cannot have a voltage difference greater than  $\pm 2$  volts.
- The specified measurement range applies *only* to the signal connected to the **Input** terminals. The signal on the **Input** terminals can be any dc voltage up to 1000 volts.

The following steps show you how to select the *ratio function* using the front-panel menu.

Shift <sup>On/Off</sup> <

**1 Turn on the menu.**

A: MEAS MENU

↓ < <

**2 Move down a level and then across to the RATIO FUNC command.**

4: RATIO FUNC

↓

**3 Move down to the “parameter” level.**

For this command, there is only one choice on this level.

DCV:DCV

Auto/Man  
ENTER

**4 Select the ratio function and turn off the menu.**

Notice that the **Ratio** annunciator turns on.

CHANGE SAVED

*To disable ratio measurements, select a different measurement function by pressing any front-panel function key.*

## To Use Reading Memory

The multimeter can store up to 512 readings in internal memory. The following steps demonstrate how to store readings and retrieve them.

### 1 Select the function.

Select any measurement function. You can also select Null, Min–Max, dB, dBm, or limit test. You can change the function at any time during reading memory.

Single

### 2 Select the single trigger mode.

Notice that the **Trig** annunciator turns on. When reading memory is enabled, readings are stored when you trigger the multimeter.

*For this example, single triggering is used to store readings. You can also use auto triggering or reading hold.*

On/Off  
Shift <

### 3 Turn on the menu.

A: MEAS MENU

> > >

### 4 Move across to the SYS MENU choice on this level.

D: SYS MENU

∨

### 5 Move down to a level to the RDGS STORE command.

1: RDGS STORE

⏏ >

**6 Move down a level and then across to the “ON” choice.**

ON

Auto/Man  
ENTER

**7 Save the change and exit the menu.**

Notice that the **Mem** (memory) annunciator turns on to indicate that the multimeter is ready to store readings. Up to 512 readings can be stored in first-in-first-out (FIFO) order. When memory is full, the **Mem** annunciator will turn off.

*Readings are preserved until you re-enable reading memory at another time, turn off the power, or perform a remote interface reset.*

Single  
Single  
Single

**8 Trigger the multimeter three times.**

This stores three readings in memory.

Recall  
Shift >

**9 Use menu recall to retrieve the stored readings.**

This takes you to the “SAVED RDGS” command in the SYS MENU.

2: SAVED RDGS



**10 Move down a level to view the first stored reading.**

*Reading memory is automatically turned off when you go to the “parameter” level in the menu.*

The first reading displayed is the first reading that was stored (FIFO). If no readings are stored in memory, “EMPTY” is displayed. The stored readings are displayed with their units ( $\mu$ , m, k, etc.) when appropriate. For example:

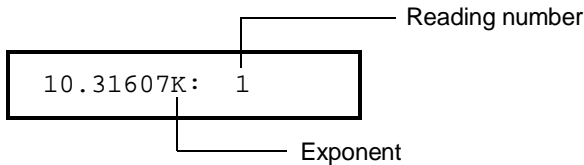

**11 Move across to view the two remaining stored readings.**

The readings are stored *horizontally* on the “parameter” level.

*If you press  when you get to the “parameter” level, you will see the last reading and you will know how many readings were stored.*

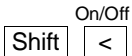

**12 Turn off the menu.**

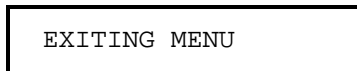

---

## Features and Functions

---

# Features and Functions

You will find that this chapter makes it easy to look up all the details about a particular feature of the multimeter. Whether you are operating the multimeter from the front panel or from the remote interface, this chapter will be useful. This chapter is divided into the following sections:

- Measurement Configuration, *starting on page 51*
- Math Operations, *starting on page 63*
- Triggering, *starting on page 71*
- System-Related Operations, *starting on page 84*
- Remote Interface Configuration, *starting on page 91*
- Calibration Overview, *starting on page 95*
- Operator Maintenance, *starting on page 100*
- Power-On and Reset State, *on page 101*

Some knowledge of the front-panel menu will be helpful before you read this chapter. If you have not already read chapter 2, “Front-Panel Menu Operation,” starting on page 25, you may want to read it now. Chapter 4, “Remote Interface Reference,” starting on page 103, lists the syntax for the SCPI commands available to program the multimeter.

Throughout this manual, the following conventions are used for SCPI command syntax for remote interface programming.

- Square brackets ( [ ] ) indicate optional keywords or parameters.
- Braces ( { } ) enclose parameters within a command string.
- Triangle brackets ( < > ) indicate that you must substitute a value for the enclosed parameter.
- A vertical bar ( | ) separates multiple parameter choices.



---

## Measurement Configuration

This section contains information to help you configure the multimeter for making measurements. You may never have to change any of the measurement parameters discussed here, but they are provided to give you the flexibility you might need.

### AC Signal Filter

The multimeter uses three different ac filters which enable you to either optimize low frequency accuracy or achieve faster ac settling times. The multimeter selects the *slow*, *medium*, or *fast* filter based on the input frequency that you specify.

*Applies to ac voltage and ac current measurements only.*

Input Frequency	AC Filter Selected	Settling Time
3 Hz to 300 kHz	Slow filter	7 seconds / reading
20 Hz to 300 kHz	Medium filter (default)	1 reading / second
200 Hz to 300 kHz	Fast filter	10 readings / second

- The ac filter selection is stored in *volatile* memory; the multimeter selects the *medium* filter (20 Hz) when power has been off or after a remote interface reset.
- *Front-Panel Operation:* Select from the menu the slow filter (3 Hz), medium filter (**20 Hz**), or fast filter (200 Hz). *The default is the medium filter.*

1: AC FILTER (MEAS MENU)

- *Remote Interface Operation:* Specify the lowest frequency expected in the input signal. The multimeter selects the appropriate filter based on the frequency you specify (*see table above*). The `CONFigure` and `MEASure?` commands select the 20 Hz filter.

```
DETECTOR: BANDwidth {3|20|200|MINimum|MAXimum}
```

### **Continuity Threshold Resistance**

When measuring continuity, the multimeter emits a continuous tone if the measured resistance is less than the *threshold resistance*. You can set the threshold to any value between 1  $\Omega$  and 1000  $\Omega$ .

*The threshold resistance is adjustable only from the front panel.*

- The threshold resistance is stored in *non-volatile* memory, and *does not* change when power has been off or after a remote interface reset.
- The factory setting for the threshold resistance is 10  $\Omega$ .
- After enabling the continuity function, you can select a different threshold resistance by pressing **Shift** **>** (Menu Recall).

2: CONTINUITY (MEAS MENU)

^0010	OHM
-------	-----

*See also "To Test Continuity," on page 19.*

## DC Input Resistance

Normally, the multimeter's input resistance is fixed at 10 M $\Omega$  for all dc voltage ranges to minimize noise pickup. To reduce the effects of measurement loading errors, you can set the input resistance to greater than 10 G $\Omega$  for the 100 mVdc, 1 Vdc, and 10 Vdc ranges.

*Applies to dc voltage measurements and is disabled for all other functions.*

	Input Resistance 100mV, 1V, 10V ranges	Input Resistance 100V, 1000V ranges
Fixed Resistance ON (default)	10 M $\Omega$	10 M $\Omega$
Fixed Resistance OFF	> 10 G $\Omega$	10 M $\Omega$

- The input resistance setting is stored in *volatile* memory; the multimeter selects 10 M $\Omega$  (for all dc voltage ranges) when power has been off or after a remote interface reset.
- *Front-Panel Operation:* Select from the menu the 10 M $\Omega$  mode (fixed resistance for all dc voltage ranges) or the >10 G $\Omega$  mode. *The default is 10 M $\Omega$ .*

3: INPUT R (MEAS MENU)

- *Remote Interface Operation:* You can enable or disable the automatic input resistance mode. With AUTO OFF (default), the input resistance is fixed at 10 M $\Omega$  for all ranges. With AUTO ON, the input resistance is set to >10 G $\Omega$  for the three lowest dc voltage ranges. The CONFigure and MEASure? commands automatically turn AUTO OFF.

INPut:IMPedance:AUTO {OFF|ON}

## Resolution

Resolution is expressed in terms of *number of digits* the multimeter can measure or display. You can set the resolution to 4, 5, or 6 *full digits*, plus a “½” digit which can only be a “0” or “1”. To increase measurement accuracy and improve noise rejection, select 6½ digits. To increase measurement speed, select 4½ digits.

*Applies to all measurement functions. The resolution for the math operations (null, min-max, dB, dBm, limit test) is the same as the resolution for the measurement function in use.*

The correspondence between the number of digits selected and the resulting integration time (in *power line cycles*) is shown below. The autozero mode is set indirectly when you set the resolution. See also “Autozero,” on page 59.

Resolution Choices	Integration Time
Fast 4 Digit * Slow 4 Digit	0.02 PLC 1 PLC
Fast 5 Digit * Slow 5 Digit ( <i>default</i> )	0.2 PLC 10 PLC
* Fast 6 Digit Slow 6 Digit	10 PLC 100 PLC

\* These settings configure the multimeter just as if you had pressed the corresponding “DIGITS” keys from the front panel.

*Resolution is local to the selected function. This means that you can select the resolution for each function independently. The multimeter remembers the resolution when you switch between functions.*

## Chapter 3 Features and Functions

### Measurement Configuration

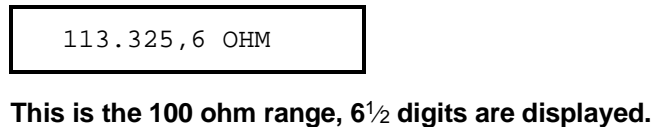
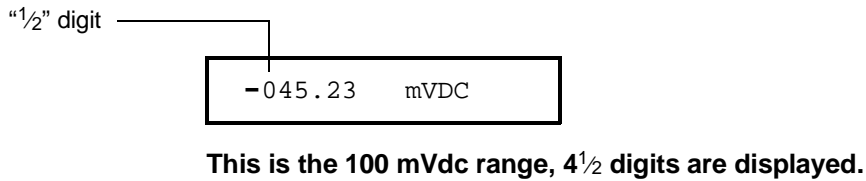
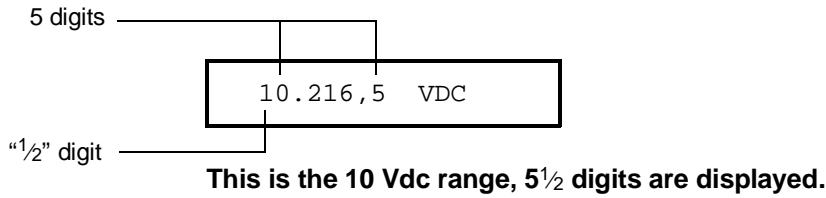

- The resolution is stored in *volatile* memory; the multimeter sets the resolution to 5<sup>1</sup>/<sub>2</sub> digits (for all functions) when power has been off or after a remote interface reset.
- The resolution is fixed at 5<sup>1</sup>/<sub>2</sub> digits for continuity and diode tests.
- For dc and resistance measurements, changing the number of digits does more than just change the resolution of the multimeter. It also changes the *integration time*, which is the period the multimeter’s analog-to-digital (A/D) converter samples the input signal for a measurement. *See also “Integration Time,” on page 57.*
- For ac measurements, the resolution is actually fixed at 6<sup>1</sup>/<sub>2</sub> digits. If you select 4<sup>1</sup>/<sub>2</sub> digits or 5<sup>1</sup>/<sub>2</sub> digits, the multimeter “masks” one or two digits. The only way to control the reading rate for ac measurements is by setting a trigger delay (*see page 79*).
- For ratio measurements, the specified resolution applies to the signal connected to the **Input** terminals.

**Resolution**  
(continued)

- *Front-Panel Operation:* Select either the slow or fast mode for each resolution setting. *The default mode is 5 digits slow.*

5: RESOLUTION (MEAS MENU)

See also "To Set the Resolution," on page 21.

- *Remote Interface Operation:* You can set the resolution using the following commands.

```
CONFigure:<function> {<range>|MIN|MAX|DEF}, {<resolution>|MIN|MAX|DEF}  
MEASure:<function>? {<range>|MIN|MAX|DEF}, {<resolution>|MIN|MAX|DEF}  
<function>:RESolution {<resolution>|MIN|MAX}
```

Specify the resolution in the same units as the measurement function, *not in number of digits*. For example, for dc volts, specify the resolution in volts. For frequency, specify the resolution in hertz.

CONF:VOLT:DC 10,0.001	<i>4½ digits on the 10 Vdc range</i>
MEAS:CURR:AC? 1,1E-6	<i>6½ digits on the 1 A range</i>
CONF:FREQ 1 KHZ,0.1 Hz	<i>1000 Hz input, 0.1 Hz resolution</i>
VOLT:AC:RES 0.05	<i>50 mV resolution on the ac function</i>

### **Integration Time**

Integration time is the period during which the multimeter's analog-to-digital (A/D) converter samples the input signal for a measurement. Integration time affects the measurement resolution (for better resolution, use a longer integration time), and measurement speed (for faster measurements, use a shorter integration time).

*Applies to all measurement functions except ac voltage, ac current, frequency, and period. The integration time for the math operations (null, min-max, dB, dBm, limit test) is the same as the integration time for the measurement function in use.*

- Integration time is specified in *number of power line cycles* (NPLCs). The choices are 0.02, 0.2, 1, **10**, or 100 power line cycles. *The default is 10 PLCs.*
- The integration time is stored in *volatile* memory; the multimeter selects 10 PLCs when power has been off or after a remote interface reset.
- Only the integral number of power line cycles (1, 10, or 100 PLCs) provide normal mode (line frequency noise) rejection.
- The only way to control the reading rate for ac measurements is by setting a trigger delay (*see page 79*).
- The following table shows the relationship between integration time and measurement resolution.

<b>Integration Time</b>	<b>Resolution</b>
0.02 NPLC	0.0001 x Full-Scale
0.2 NPLC	0.00001 x Full-Scale
1 NPLC	0.000003 x Full-Scale
10 NPLC	0.000001 x Full-Scale
100 NPLC	0.0000003 x Full-Scale

**Integration Time**  
*(continued)*

- *Front-Panel Operation:* Integration time is set indirectly when you select the number of digits. *See the table for resolution on page 54.*
- *Remote Interface Operation:*

```
<function>:NPLCycles {0.02|0.2|1|10|100|MINimum|MAXimum}
```

For frequency and period measurements, *aperture time* (or gate time) is analogous to integration time. Specify **10 ms** (4½ digits), **100 ms** (default; 5½ digits), or **1 second** (6½ digits).

```
FREQUENCY:APERTure {0.01|0.1|1|MINimum|MAXimum}  
PERiod:APERTure {0.01|0.1|1|MINimum|MAXimum}
```

### **Front / Rear Input Terminal Switching**

Any measurement made using the front terminals can also be made using the input terminals on the rear panel. See “The Front Panel at a Glance,” on page 2, for the location of the front/rear switch.

*The input terminals can only be configured from the front panel. You cannot select the terminals from the remote interface, but you can query the present setting.*

- The **Rear** annunciator turns on when you select the rear terminals.
- *Remote Interface Operation:* You can query the multimeter to determine whether the front or rear input terminals are selected.

```
ROUTE:TERMINals?      returns “FRON” or “REAR”
```



### **Autozero**

When autozero is *enabled* (default), the multimeter internally disconnects the input signal following each measurement, and takes a *zero reading*. It then subtracts the zero reading from the preceding reading. This prevents offset voltages present on the multimeter's input circuitry from affecting measurement accuracy.

When autozero is *disabled*, the multimeter takes one zero reading and subtracts it from all subsequent measurements. It takes a new zero reading each time you change the function, range, or integration time.

*Applies to dc voltage, dc current, and 2-wire ohms measurements only. Autozero is enabled when you select 4-wire ohms or ratio measurements.*

- The autozero mode is stored in *volatile* memory; the multimeter automatically enables autozero when power has been off or after a remote interface reset.
- *Front-Panel Operation:* The autozero mode is set indirectly when you set the resolution.

Resolution Choices	Integration Time	Autozero
Fast 4 Digit	0.02 PLC	Off
* Slow 4 Digit	1 PLC	On
Fast 5 Digit	0.2 PLC	Off
* Slow 5 Digit ( <i>default</i> )	10 PLC	On
* Fast 6 Digit	10 PLC	On
Slow 6 Digit	100 PLC	On

\* These settings configure the multimeter just as if you had pressed the corresponding "DIGITS" keys from the front panel.

- *Remote Interface Operation:* The OFF and ONCE parameters have a similar effect. Autozero OFF *does not* issue a new zero measurement. Autozero ONCE issues an immediate zero measurement.

```
ZERO:AUTO {OFF|ONCE|ON}
```

Chapter 3 Features and Functions  
**Measurement Configuration**

**Autozero**  
*(continued)*

The following table shows the relationship between integration time and autozero settings from the remote interface and the corresponding front-panel settings.

Remote Configuration	Front-Panel Equivalent	From 34401A Specifications: <sup>1</sup>	
		Digits Displayed	Readings/Sec
NPLC: 100 Autozero: On Digits Displayed: 6½	Slow 6 digits	N/A	N/A
NPLC: 100 Autozero: Off Digits Displayed: 6½	N/A	6½	0.6
NPLC: 10 Autozero: On Digits Displayed: 6½	Fast 6 digits Slow 5 digits	N/A	N/A
NPLC: 10 Autozero: Off Digits Displayed: 6½	N/A	6½	6
NPLC: 1 Autozero: On Digits Displayed: 5½	Slow 4 digits	N/A	N/A
NPLC: 1 Autozero: Off Digits Displayed: 5½	N/A	5½	60
NPLC: 0.2 Autozero: On Digits Displayed: 5½	N/A	N/A	N/A
NPLC: 0.2 Autozero: Off Digits Displayed: 5½	Fast 5 digits	5½	300
NPLC: 0.02 Autozero: On Digits Displayed: 4½	N/A	N/A	N/A
NPLC: 0.02 Autozero: Off Digits Displayed: 4½	Fast 4 digits	4½	1000

<sup>1</sup> See the Agilent 34401A specifications listed on page 217.

## **Ranging**

You can let the multimeter automatically select the range using *autoranging* or you can select a fixed range using *manual ranging*. Autoranging is convenient because the multimeter automatically selects the appropriate range for each measurement. However, you can use manual ranging for faster measurements since the multimeter does not have to determine which range to use for each measurement.

- The selected mode (auto or manual range) is stored in *volatile* memory; the multimeter returns to autoranging when power has been off or after a remote interface reset.
- Autorange thresholds:
  - Down range at <10% of range
  - Up range at >120% of range
- If the input signal is greater than the present range can measure, the multimeter gives an *overload indication*: “OVL D” from the front panel or “9.90000000E+37” from the remote interface.
- For frequency and period measurements, the multimeter uses one “range” for all inputs between 3 Hz and 300 kHz. The multimeter determines an internal resolution based on a 3 Hz signal. If you query the range, the multimeter will respond with “3 Hz”. With no input signal applied, frequency and period measurements return “0”.
- The range is fixed for continuity tests (1 k $\Omega$  range) and diode tests (1 Vdc range with 1 mA current source output).
- For ratio measurements, the specified range applies to the signal connected to the **Input** terminals. Autoranging is automatically selected for reference voltage measurements on the **Sense** terminals.

*Ranging is local to the selected function. This means that you can select the ranging method (auto or manual) for each function independently. When manually ranging, the selected range is local to the function; the multimeter remembers the range when you switch between functions.*

**Ranging**  
(continued)

- *Front-Panel Operation:* Use the front-panel RANGE keys to select autoranging or manual ranging. For frequency and period measurements from the front panel, ranging applies to the signal's input *voltage*, not its frequency.

*See also "To Select a Range," on page 20.*

- *Remote Interface Operation:* You can set the range using any of the following commands.

```
CONFigure:<function> {<range>|MIN|MAX|DEF}, {<resolution>|MIN|MAX|DEF}  
MEASure:<function>? {<range>|MIN|MAX|DEF}, {<resolution>|MIN|MAX|DEF}  
<function>:RANGe {<range>|MINimum|MAXimum}  
<function>:RANGe:AUTO {OFF|ON}
```

## Math Operations

There are five math operations available, only one of which can be enabled at a time. Each math operation performs a mathematical operation on each reading or stores data on a series of readings. The selected math operation remains in effect until you disable it, change functions, turn off the power, or perform a remote interface reset. The math operations use one or more internal registers. You can preset the values in some of the registers, while others hold the results of the math operation.

The following table shows the math/measurement function combinations allowed. Each “X” indicates an allowable combination. If you choose a math operation that is not allowed with the present measurement function, math is turned off. If you select a valid math operation and then change to one that is invalid, a “Settings conflict” error is generated from the remote interface.

	DC V	AC V	DC I	AC I	$\Omega$ 2W	$\Omega$ 4W	Freq	Per	Cont	Diode	Ratio
Null	X	X	X	X	X	X	X	X			
Min-Max	X	X	X	X	X	X	X	X			X
dB	X	X									
dBm	X	X									
Limit	X	X	X	X	X	X	X	X			X

From the front panel, you enable a math operation by pressing the appropriate key. The exception is Limit Test which you enable using the LIMIT TEST command in the MATH MENU.

From the remote interface, the math operations and registers are controlled using commands within the CALCulate command subsystem. First, select the math operation you want to use (*the default function is null*):

```
CALCulate:FUNCTION {NULL|DB|DBM|AVERage|LIMit}
```

Then, enable the selected math function by turning the math state on:

```
CALCulate:STATE ON
```

## Math Operations

### Min-Max Operation

The min-max operation stores the minimum and maximum readings during a series of measurements. The multimeter then calculates the average of all readings and records the number of readings taken since min-max was enabled.

*Applies to all measurement functions, except continuity and diode.*

- After you enable min-max, the first reading that the multimeter takes is stored as both the minimum and maximum value. The *minimum* is replaced with any subsequent value that is less. The *maximum* is replaced with any subsequent value that is greater.
- The multimeter displays “MIN” or “MAX” and beeps (if the front-panel beeper is enabled) whenever a new minimum or maximum is found. It is possible that the multimeter will beep even if the displayed reading does not change; this is because the multimeter’s internal resolution may be greater than the displayed resolution. *See also “Beeper Control,” on page 88.*
- The minimum, maximum, average, and count are stored in *volatile* memory; the multimeter clears the values when min-max is turned on, when power has been off, or after a remote interface reset.
- *Front-Panel Operation:* After enabling min-max, you can read the stored minimum, maximum, average, and count by pressing   (Menu Recall). Turning on the menu does not disable the min-max operation; the multimeter will resume taking measurements when you turn off the menu.

1: MIN-MAX (MATH MENU)

*See also “To Store Minimum and Maximum Readings,” on page 39.*

**Math Operations**

- *Remote Interface Operation:* You can use the following commands to make min-max measurements.

CALCulate:FUNctIon AVERage	
CALCulate:STATe {OFF ON}	
CALCulate:AVERage:MINimum?	<i>read the minimum value</i>
CALCulate:AVERage:MAXimum?	<i>read the maximum value</i>
CALCulate:AVERage:AVERage?	<i>read the average of all readings</i>
CALCulate:AVERage:COUNT?	<i>read the count</i>

*A new command is available starting with firmware Revision 2 which allows you to take readings using INITiate without storing them in internal memory. This command may be useful with the min-max operation since it allows you to determine the average of a series of readings without storing the individual values.*

DATA:FEED RDG_STORE, ""	<i>do not store readings</i>
DATA:FEED RDG_STORE, "CALCulate"	<i>store readings (default)</i>

*See page 126 for more information on using the DATA:FEED command.*

**Null (Relative) Operation**

When making null measurements, also called *relative*, each reading is the difference between a stored null value and the input signal. One possible application is in making more accurate two-wire ohms measurements by nulling the test lead resistance.

**Result** = reading - null value

*Applies to all measurement functions, except continuity, diode, and ratio.*

- The null value is adjustable and you can set it to any value between 0 and  $\pm 120\%$  of the highest range, for the present function.
- The null value is stored in *volatile* memory; the value is cleared when power has been off, after a remote interface reset, or after a function change.

**Math Operations****Null (Relative)***(continued)*

- The null value is stored in the multimeter's Null Register. There are two ways you can specify the null value. First, you can enter a specific number into the register from the front-panel menu or from the remote interface. Any previously stored value is replaced with the new value. *If you are operating the multimeter from the front panel, entering a null value also turns on the null function.*

The second way to enter the null value is to let the multimeter store the first reading in the register. *After you enable null, the first reading displayed will be zero (if you have not changed the value stored in the register).* If you entered a number into the register, as described in the paragraph above, the first reading *does not* overwrite the stored value.

- *Front-Panel Operation:* After enabling null, you can edit the stored null value by pressing `[Shift] >` (Menu Recall). Any previously stored value is replaced with the new value. Turning on the menu does not disable the null operation; the multimeter will resume taking measurements when you turn off the menu.

2: NULL VALUE (MATH MENU)

*See also "To Make Null (Relative) Measurements," on page 38.*

- *Remote Interface Operation:* You can use the following commands to make null measurements. *Math must be enabled before you can store a value in the Null Register.*

```
CALCulate:FUNCTION NULL
CALCulate:STATE {OFF|ON}
CALCulate:NULL:OFFSet {<value>|MINimum|MAXimum}
```

The following program segment shows the proper order that you should execute the commands to enable null and set an offset value.

```
CALC:FUNC NULL
CALC:STAT ON
CALC:NULL:OFFS -2.0
```



**Math Operations****dB Measurements**

Each dB measurement is the difference between the input signal and a stored relative value, with both values converted to dBm.

$$dB = \text{reading in dBm} - \text{relative value in dBm}$$

*Applies to dc voltage and ac voltage measurements only.*

- The relative value is adjustable and you can set it to any value between 0 dBm and  $\pm 200.00$  dBm.
- The relative value is stored in *volatile* memory; the value is cleared when power has been off, after a remote interface reset, or after a function change.
- The relative value is stored in the multimeter's dB Relative Register. There are two ways you can specify the relative value. First, you can enter a specific number into the register from the front-panel menu or from the remote interface. Any previously stored value is replaced with the new value. *If you are operating the multimeter from the front panel, entering a relative value also turns on the dB function.*

The second way to enter the relative value is to let the multimeter take the first reading, convert it to dBm, and store that value in the register. Changing the dBm reference resistance (*see page 68*) does not change the stored relative value. *After you enable dB, the first reading taken will be 0 dB (if you have not changed the value stored in the register).* If you entered a number into the register, as described in the paragraph above, the first reading *does not* overwrite the stored value.

- *Front-Panel Operation:* After enabling dB, you can edit the stored relative value by pressing **Shift** **>** (Menu Recall). Any previously stored value is replaced with the new value. Turning on the menu does not disable the dB operation; the multimeter will resume taking measurements when you turn off the menu.

3: dB REL (MATH MENU)

*See also "To Make dB Measurements," on page 40.*

**Math Operations**

- *Remote Interface Operation:* You can use the following commands to make dB measurements. *Math must be enabled before you can store a value to the Relative Register.*

```
CALCulate:FUNCTION DB
CALCulate:STATE {OFF|ON}
CALCulate:DB:REFERENCE {<value>|MINimum|MAXimum}
```

**dBm Measurements**

The dBm operation calculates the power delivered to a resistance referenced to 1 milliwatt.

$$dBm = 10 \times \text{Log}_{10} ( \text{reading}^2 / \text{reference resistance} / 1 \text{ mW} )$$

*Applies to dc voltage and ac voltage measurements only.*

- You can choose from 17 different reference resistance values. The factory setting for the reference resistance is 600Ω.

The choices are: 50, 75, 93, 110, 124, 125, 135, 150, 250, 300, 500, **600**, 800, 900, 1000, 1200, or 8000 ohms.

- The reference resistance is stored in *non-volatile* memory, and *does not* change when power has been off or after a remote interface reset.
- *Front-Panel Operation:* After enabling dBm, you can select a new reference resistance by pressing Shift > (Menu Recall). Turning on the menu does not disable the dBm operation; the multimeter will resume taking measurements when you turn off the menu.

```
4: dBm REF R (MATH MENU)
```

*See also "To Make dBm Measurements," on page 41.*

- *Remote Interface Operation:* You can use the following commands to make dBm measurements.

```
CALCulate:FUNCTION DBM
CALCulate:STATE {OFF|ON}
CALCulate:DBM:REFERENCE {<value>|MINimum|MAXimum}
```

**Math Operations****Limit Testing**

The limit test operation enables you to perform pass/fail testing to upper and lower limits that you specify.

*Applies to all measurement functions, except continuity and diode tests.*

- You can set the upper and lower limits to any value between 0 and  $\pm 120\%$  of the highest range, for the present function. The upper limit selected should always be a more positive number than the lower limit. *The default upper and lower limits are both “0”.*
- The upper and lower limits are stored in *volatile* memory; the multimeter sets both limits to “0” when power has been off, after a remote interface reset, or after a function change.
- You can configure the multimeter to generate a service request (SRQ) on the first occurrence of a failed reading. *See “The SCPI Status Model,” starting on page 134 for more information.*
- *Front-Panel Operation:* The multimeter displays “OK” for each reading that is within the specified limits. It displays “HI” or “LO” for each reading that exceeds the upper or lower limit. The multimeter beeps once (if the front-panel beeper is enabled) on the first occurrence of a failed reading after a good reading. *See also “Beeper Control,” on page 88.*

5: LIMIT TEST	(MATH MENU)	<i>enable or disable limit test</i>
6: HIGH LIMIT	(MATH MENU)	<i>set the upper limit</i>
7: LOW LIMIT	(MATH MENU)	<i>set the lower limit</i>

*You can also turn off limit test by selecting a different math operation from the front panel (only one math operation can be enabled at a time).*

**Math Operations****Limit Testing**  
(continued)

- *Remote Interface Operation:* You can use the following commands for limit testing.

```

CALCulate:FUNCTION LIMit
CALCulate:STATe {OFF|ON}
CALCulate:LIMit:LOWer {<value>|MINimum|MAXimum}
CALCulate:LIMit:UPPer {<value>|MINimum|MAXimum}

```

- There are two unused pins on the RS-232 interface connector which are available to indicate the pass/fail status of readings taken with limit testing. To configure these pins for limit testing, you must install two jumpers inside the multimeter. *See the Service Guide for more information.*

A *low-going* pulse is output to pin 1 for each reading that is within the specified limits. A low-going pulse is output to pin 9 for each reading that exceeds the upper or lower limit.

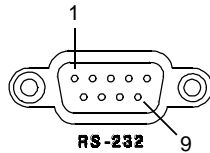

Pin 1: Pass Output  
Pin 9: Fail Output

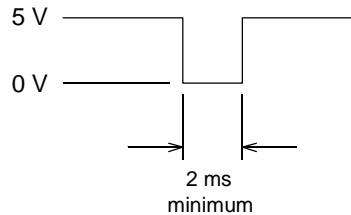
**Caution**

*Do not use the RS-232 interface if you have configured the multimeter to output pass/fail signals on pins 1 and 9. Internal components on the RS-232 interface circuitry may be damaged.*

---

## Triggering

The multimeter's triggering system allows you to generate triggers either manually or automatically, take multiple readings per trigger, and insert a delay before each reading. Normally, the multimeter will take one reading each time it receives a trigger, but you can specify multiple readings (up to 50,000) per trigger.

You can trigger the multimeter from the front panel using a single trigger, an external trigger, or auto triggering. Single triggering takes one reading each time you press the `[Single]` key. External triggering is like single triggering, but the multimeter waits for a pulse on the rear-panel *Ext Trig* (external trigger) terminal before taking a reading. Auto triggering takes continuous readings at the fastest rate possible for the present configuration. *See also "To Trigger the Multimeter," on page 42.*

Triggering the multimeter from the remote interface is a multi-step process that offers triggering flexibility.

- First, you must configure the multimeter for the measurement by selecting the function, range, resolution, etc.
- Then, you must specify the source from which the multimeter will accept the trigger. The multimeter will accept a software (bus) trigger from the remote interface, a hardware trigger from the *Ext Trig* terminal, or an immediate internal trigger.
- Then, you must make sure that the multimeter is ready to accept a trigger from the specified trigger source (this is called the *wait-for-trigger* state).

*The diagram on the next page shows the multimeter's triggering system.*

**Triggering**

**Agilent 34401A Triggering System**

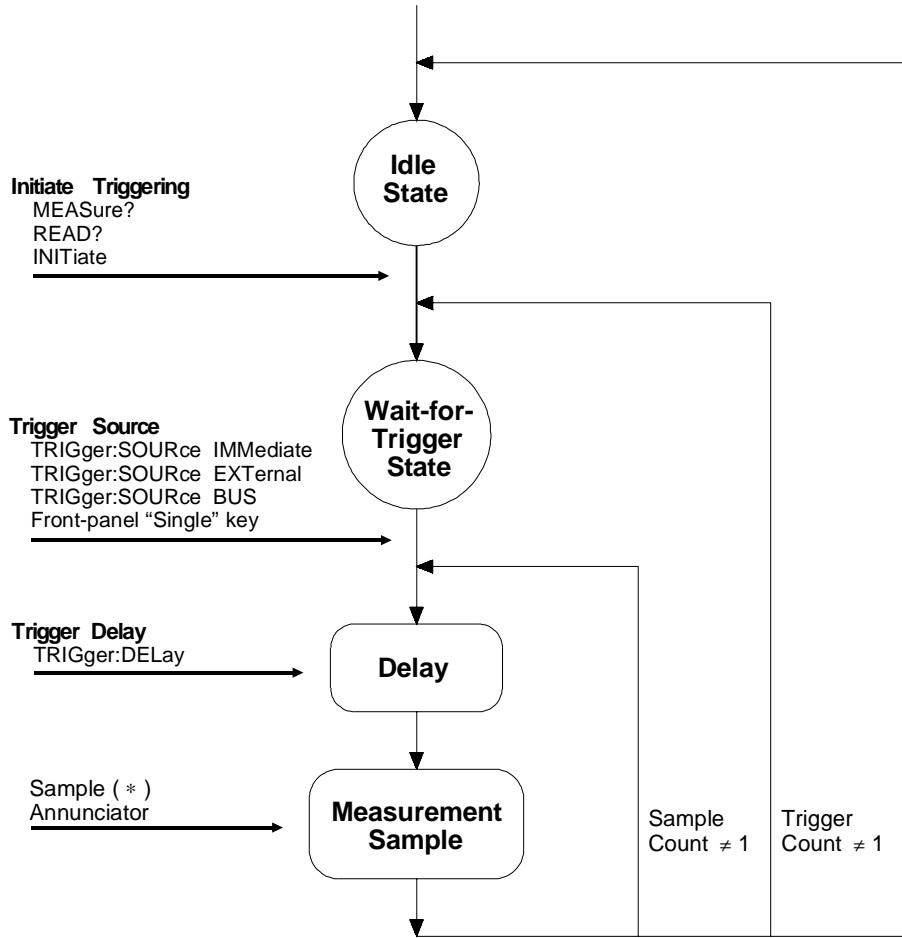

## Triggering

### Trigger Source Choices

You must specify the source from which the multimeter will accept a trigger. From the front panel, the multimeter will accept a single trigger, a hardware trigger from the *Ext Trig* terminal, or continuously take readings using auto trigger. At power-on, auto triggering is used. From the remote interface, the multimeter will accept a software (bus) trigger, a hardware trigger from the *Ext Trig* terminal, or an immediate internal trigger. The Q (sample) annunciator turns on during each measurement.

- The trigger source is stored in *volatile* memory; the source is set to auto trigger (front panel) or immediate (remote interface) when power has been off or after a remote interface reset.
- To select the trigger source from the remote interface, use the following command. The `CONFigure` and `MEASure?` commands automatically set the trigger source to `IMMEDIATE`.

```
TRIGger:SOURce {BUS|IMMEDIATE|EXTernal}
```

**Auto Triggering** In the auto trigger mode (front panel only), the multimeter continuously takes readings at the fastest rate possible for the present configuration. This is the power-on trigger source for front-panel operation.

**Single Triggering** In the single trigger mode (front panel only), you can manually trigger the multimeter by pressing `Single`. The multimeter takes one reading, or the specified number of readings (sample count), each time you press the key. The **Trig** annunciator turns on when the multimeter is waiting for a trigger.

*The front-panel `Single` key is disabled when in remote.*

## Triggering

**External Triggering** In the external trigger mode, the multimeter will accept a hardware trigger applied to the *Ext Trig* terminal. The multimeter takes one reading, or the specified number of readings (sample count), each time *Ext Trig* receives a low-true pulse.

See also “External Trigger Terminal,” on page 83.

- The multimeter buffers one external trigger. This means that if the multimeter is taking a reading and another external trigger occurs, that trigger is accepted (a “Trigger ignored” error is not reported). After the reading in progress is complete, the stored trigger satisfies the trigger source and then the trigger is issued.
- *Front-Panel Operation:* The external trigger mode is like the single trigger mode except that you apply the trigger to the *Ext Trig* terminal. Pressing  to enable the single trigger mode also enables the external trigger mode. The **Trig** annunciator turns on when the multimeter is waiting for an external trigger.

The front-panel  key is disabled when in remote.

- *Remote Interface Operation:*

```
TRIGger:SOURce EXTernal
```



## Triggering

**Internal Triggering** In the internal trigger mode (remote interface only), the trigger signal is always present. When you place the multimeter in the wait-for-trigger state, the trigger is issued immediately. This is the power-on trigger source for remote interface operation.

To select the internal trigger source, send the following command. The `CONFigure` and `MEASure?` commands automatically set the trigger source to `IMMEDIATE`.

```
TRIGger:SOURce IMMEDIATE
```

**Software (Bus) Triggering** The bus trigger mode is available only from the remote interface. This mode is similar to the single trigger mode from the front panel, but you trigger the multimeter by sending a bus trigger command.

- To select the bus trigger source, send the following command.

```
TRIGger:SOURce BUS
```

- To trigger the multimeter from the remote interface (GPIB or RS-232), send the `*TRG` (trigger) command. The `*TRG` command *will not* be accepted unless the multimeter is in the wait-for-trigger state.
- You can also trigger the multimeter from the GPIB interface by sending the IEEE-488 Group Execute Trigger (GET) message. The multimeter must be in the wait-for-trigger state. The following statement shows how to send a GET using *BASIC*.

```
TRIGGER 722      Group Execute Trigger
```

## Triggering

### The Wait-for-Trigger State

After you have configured the multimeter and selected a trigger source, you must place the multimeter in the *wait-for-trigger* state. A trigger will not be accepted until the multimeter is in this state. If a trigger signal is present, and if multimeter is in the “wait-for-trigger” state, the measurement sequence begins and readings are taken.

*The “wait-for-trigger” state is a term used primarily for remote interface operation. From the front panel, the multimeter is always in the “wait-for-trigger” state and will accept triggers at any time, unless a measurement is already in progress.*

You can place the multimeter in the “wait-for-trigger” state by executing any of the following commands from the remote interface.

```
MEASure?  
READ?  
INITiate
```

*The multimeter requires approximately 20 ms of set-up time after you send a command to change to the “wait-for-trigger” state. Any external triggers that occur during this set-up time are ignored.*

### Halting a Measurement in Progress

You can send a device clear at any time to halt a measurement in progress and place the multimeter in the “idle state.” The following statement shows how to send a device clear over the GPIB interface using *BASIC*.

```
CLEAR 722            IEEE-488 Device Clear
```

A device clear does not affect the configuration of the triggering system. The trigger source, sample count, trigger delay, and number of triggers *are not* changed.

## Triggering

### Number of Samples

Normally, the multimeter takes one reading (or sample) each time it receives a trigger from the selected trigger source (if the multimeter is in the wait-for-trigger state). You can, however, instruct the multimeter to take multiple readings for each trigger received.

- Number of samples: 1 to 50,000. *The default is 1 sample per trigger.*
- The selected number of samples is stored in *volatile* memory; the multimeter sets the sample count to 1 when power has been off or after a remote interface reset. The `CONFigure` and `MEASure?` commands automatically set the sample count to 1.
- *Front-Panel Operation:*

```
3: N SAMPLES (TRIG MENU)
```

- *Remote Interface Operation:*

```
SAMPlE:COUNT {<value> | MINimum | MAXimum}
```

## Triggering

### Number of Triggers

Normally, the multimeter will accept only one trigger before returning to the “idle” trigger state. You can, however, instruct the multimeter to accept multiple triggers.

*This feature is available only from the remote interface. If you set the trigger count and then go to local (front panel), the multimeter ignores the trigger count setting; when you return to remote, the trigger count returns to the value you selected.*

- Number of triggers: 1 to 50,000. *The default is 1 trigger.*
- The selected number of triggers is stored in *volatile* memory; the multimeter sets the trigger count to 1 when power has been off or after a remote interface reset. The `CONFigure` and `MEASure?` commands automatically set the trigger count to 1.
- *Remote Interface Operation:*

```
TRIGger:COUNT {<value> | MINimum | MAXimum | INFinite}
```

## Triggering

### Trigger Delay

You can insert a delay between the trigger signal and each sample that follows. This may be useful in applications where you want to allow the input to settle before taking a reading, or for pacing a burst of readings. If you do not specify a trigger delay, the multimeter automatically selects a delay for you.

- Delay range: 0 to 3600 seconds. *The default trigger delay is automatic; the delay is determined by function, range, integration time, and ac filter setting (see also “Automatic Trigger Delays,” on page 81).*
- The trigger delay is stored in *volatile* memory; the multimeter selects an automatic trigger delay when power has been off or after a remote interface reset. The `CONFigure` and `MEASure?` commands automatically set the trigger delay to automatic.
- If you specify a delay other than automatic, *that same delay* is used for *all* functions and ranges.
- If you have configured the multimeter to take more than one reading per trigger (sample count > 1), the specified trigger delay is inserted between the trigger and *each* reading.
- *Front-Panel Operation:* You can use an automatic trigger delay or you can specify a delay in seconds.

2: TRIG DELAY (TRIG MENU)

If an automatic trigger delay is enabled, “AUTO” is displayed momentarily before the actual number of seconds is displayed.

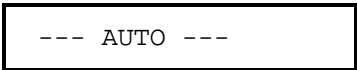

--- AUTO ---

**Triggering****Trigger Delay**  
*(continued)*

- *Front-Panel Operation (continued)*

To set the delay to 0 seconds, select the “parameter” level of the TRIG DELAY command. Move the flashing cursor to the “units” location on the right side of the display. Press  until ZERO DELAY is reached, then press Menu Enter.

ZERO DELAY

To select the automatic trigger delay, select the “parameter” level of the TRIG DELAY command. Move the flashing cursor to the “units” location on the right side of the display. Press  until AUTO DELAY is reached, then press Menu Enter.

AUTO DELAY

- *Remote Interface Operation:*

You can use the following command to set the trigger delay.

```
TRIGger:DElay {<seconds>|MINimum|MAXimum}
```

You can use the following command to set an automatic trigger delay.

```
TRIGger:DElay:AUTO {OFF|ON}
```

**Triggering****Automatic Trigger Delays**

If you do not specify a trigger delay, the multimeter selects an automatic delay for you. The delay is determined by function, range, integration time, and ac filter setting.

- *DC Voltage and DC Current (for all ranges):*

Integration Time	Trigger Delay
NPLC $\geq$ 1	1.5 ms
NPLC $<$ 1	1.0 ms

- *Resistance (2-wire and 4-wire):*

Range	Trigger Delay (For NPLC $\geq$ 1)
100 $\Omega$	1.5 ms
1 k $\Omega$	1.5 ms
10 k $\Omega$	1.5 ms
100 k $\Omega$	1.5 ms
1 M $\Omega$	15 ms
10 M $\Omega$	100 ms
100 M $\Omega$	100 ms

Range	Trigger Delay (For NPLC $<$ 1)
100 $\Omega$	1.0 ms
1 k $\Omega$	1.0 ms
10 k $\Omega$	1.0 ms
100 k $\Omega$	1.0 ms
1 M $\Omega$	10 ms
10 M $\Omega$	100 ms
100 M $\Omega$	100 ms

- *AC Voltage and AC Current (for all ranges):*

Remote or single/external trigger

AC Filter	Trigger Delay
Slow	7.0 sec
Medium	1.0 sec
Fast	600 ms

Front panel with auto trigger ON

AC Filter	Trigger Delay
Slow	1.5 sec
Medium	200 ms
Fast	100 ms

- *Frequency and Period:*

Remote or single/external trigger

Trigger Delay
1.0 sec

Front panel with auto trigger ON

Trigger Delay
0 sec

## Triggering

### Reading Hold

The reading hold feature allows you to capture and hold a stable reading on the front-panel display. This is especially useful in situations where you want to take a reading, remove the test probes, and have the reading remain on the display. When a stable reading is detected, the multimeter emits a beep (if the front-panel beeper is enabled) and holds the reading on the display. *See also “Beeper Control,” on page 88.*

*The reading hold feature is available only from the front panel. If you go to remote when reading hold is enabled, the multimeter ignores it; when you return to local (front panel), reading hold is enabled again.*

- Reading hold has an adjustable *sensitivity band* (adjustable only from the front panel) to allow you to select which readings are considered stable enough to be displayed. The band is expressed as a percent of reading, on the selected range. The multimeter will capture and display a new value only after *three* consecutive readings are within the band.

Select one of these values: 0.01%, **0.10%** (default), 1.00%, or 10.00% of reading. For example, assume that the 1.00% band is selected and a 5 volt signal is applied to the multimeter. If three consecutive readings are between 4.975 volts and 5.025 volts, the display will show a new reading.

- The sensitivity band is stored in *volatile* memory; the multimeter sets the band to 0.10% when power has been off or after an interface reset.
- If the multimeter is in *autorange* when you enable reading hold, it will autorange to the correct range. If the multimeter is in the *manual range* mode, the same fixed range will be used for reading hold.
- When reading hold is enabled, the input resistance is automatically set to 10 M $\Omega$  (AUTO OFF) for all dc voltage ranges. This helps to minimize noise pickup when the test leads are open-circuit.
- For certain applications, it may be useful to use reading hold with reading memory. *See also “Reading Memory,” on page 84.*
- *Front-Panel Operation:* After enabling reading hold, you can select a different sensitivity band by pressing Shift > (Menu Recall).

1: READ HOLD (TRIG MENU)

*See also “To Use Reading Hold,” on page 43.*



## Triggering

### Voltmeter Complete Terminal

The rear-panel *VM Comp* (voltmeter complete) terminal provides a low-true pulse after the completion of each measurement. Voltmeter complete and external trigger (*see below*) implement a standard hardware handshake sequence between measurement and switching devices.

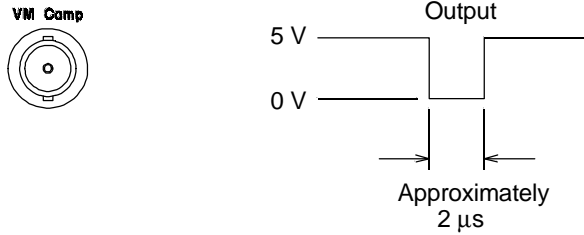

### External Trigger Terminal

You can trigger the multimeter by applying a low-true pulse to the rear-panel *Ext Trig* (external trigger) terminal. To use this terminal from the remote interface, you must select the external trigger source (TRIGger:SOURce EXTERNAL).

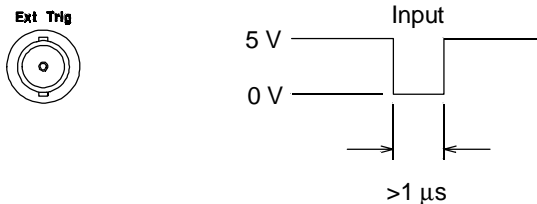

You can use a simple switch to generate an external trigger using the *Ext Trig* input as shown below.

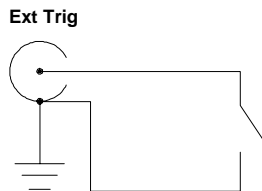

## System-Related Operations

This section gives information on topics such as reading memory, errors, self-test, and front-panel display control. This information is not directly related to making measurements but is an important part of operating the multimeter.

### Reading Memory

The multimeter can store up to 512 readings in internal memory. Readings are stored in first-in-first-out (FIFO) order. The first reading returned is the first reading stored. *The reading memory feature is available only from the front panel.*

- You can use reading memory with all functions, math operations, and also reading hold. After you have enabled reading memory, you can change the function. *Be aware, however, that the function labels (VDC, OHM, etc.) are not stored with the reading.*
- Readings taken while reading memory is enabled are stored in *volatile* memory; the multimeter clears the stored readings when reading memory is turned on again, when power has been off, after a self-test, or after a remote interface reset.
- You can use reading memory with auto trigger, single trigger, external trigger, and reading hold. If you configure the multimeter for multiple readings per trigger, the specified number of readings are stored in memory each time a trigger is received.
- *Front-Panel Operation:*

1: RDGS STORE	(SYS MENU)	<i>store readings in memory</i>
2: SAVED RDGS	(SYS MENU)	<i>read the stored readings</i>

Reading memory is automatically turned off when you go to the “parameter” level in the menu to recall the readings. *See also “To Use Reading Memory,” on page 46.*

- *Remote Interface Operation:* The INITiate command uses reading memory to store readings prior to a FETCh? command. You can query the number of stored readings in memory by sending the DATA:POINTs? command from the remote interface.

### Error Conditions

When the front-panel **ERROR** annunciator turns on, one or more command syntax or hardware errors have been detected. A record of up to 20 errors is stored in the multimeter's *error queue*. See chapter 5, "Error Messages," for a complete listing of the errors.

- Errors are retrieved in first-in-first-out (FIFO) order. The first error returned is the first error that was stored. When you have read all errors from the queue, the **ERROR** annunciator turns off. The multimeter beeps once each time an error is generated.
- If more than 20 errors have occurred, the last error stored in the queue (the most recent error) is replaced with `-350`, "Too many errors". No additional errors are stored until you remove errors from the queue. If no errors have occurred when you read the error queue, the multimeter responds with `+0`, "No error".
- The error queue is cleared when power has been off or after a `*CLS` (clear status) command has been executed. The `*RST` (reset) command *does not* clear the error queue.
- *Front-Panel Operation:*

3: ERROR (SYS MENU)

If the **ERROR** annunciator is on, press `Shift <` (Recall Menu) to read the errors stored in the queue. The errors are listed *horizontally* on the "parameter" level. All errors are cleared when you go to the "parameter" level and then turn off the menu.

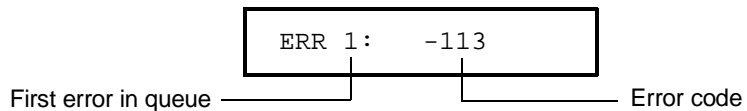

- *Remote Interface Operation:*

`SYSTEM:ERRor?`      *Reads one error from the error queue*

Errors have the following format (*the error string may contain up to 80 characters*):

```
-113, "Undefined header"
```

**System-Related Operations****Self-Test**

A *power-on* self-test occurs automatically when you turn on the multimeter. This limited test assures you that the multimeter is operational. This self-test does not perform the extensive set of analog tests that are included as part of the complete self-test described below.

A *complete* self-test runs a series of tests and takes approximately 15 seconds to execute. If all tests pass, you can have a high confidence that the multimeter is operational.

- The results of the complete self-test are stored in internal reading memory (*see page 84*). Memory is cleared as the self-test stores this information. Other than clearing memory, the complete self-test *does not* alter the state of the multimeter.
- If the complete self-test is successful, “PASS” is displayed on the front panel. If the self-test fails, “FAIL” is displayed and the **ERROR** annunciator turns on. See the *Service Guide* for instructions on returning the multimeter to Agilent for service.
- *Front-Panel Operation:* You can perform some of the tests (complete self-test) individually or you can perform all tests together at once.

4: TEST (SYS MENU)

Another way to perform the complete front-panel self-test is as follows: Hold down Shift as you press the Power switch to turn on the multimeter; *hold down the key for more than 5 seconds*. The self-test will begin when you release the key.

- *Remote Interface Operation:*

\*TST?

Returns “0” if the self-test is successful, or “1” if it fails.

## Display Control

To speed up your measurement rate, or for security reasons, you may want to turn off the front-panel display. From the remote interface, you can also display a 12-character message on the front panel.

- When the display is turned off, readings are not sent to the display and all display annunciators except **ERROR** and **Shift** are disabled. Front-panel operation is otherwise unaffected by turning off the display.
- The display state is stored in *volatile* memory; the display is enabled when power has been off or after a remote interface reset.
- You can display a message on the front panel by sending a command from the remote interface. The multimeter can display up to 12 characters of the message on the front panel; any additional characters are truncated. Commas, periods, and semicolons share a display space with the preceding character, and are not considered individual characters. When a message is displayed, readings are not sent to the display.
- Sending a message to the display from the remote interface overrides the display state; this means that you can display a message even if the display is turned off.
- *Front-Panel Operation:*

```
5: DISPLAY (SYS MENU)
```

The display always turns on for menu operation; this means that even when the display is turned off, you can still operate the menu.

- *Remote Interface Operation:*

<code>DISPlay {OFF ON}</code>	<i>disable/enable the display</i>
<code>DISPlay:TEXT &lt;quoted string&gt;</code>	<i>display the string enclosed in quotes</i>
<code>DISPlay:TEXT:CLEar</code>	<i>clear the displayed message</i>

The following command string shows how to display a message on the front panel.

```
"DISP:TEXT 'HELLO' "
```

**System-Related Operations****Beeper Control**

Normally, the multimeter will emit a tone whenever certain conditions are met from the front panel. For example, the multimeter will beep when a stable reading is captured in reading hold. You may want to disable the front-panel beeper for certain applications.

- When you disable the beeper, the multimeter *will not* emit a tone when:
  - 1) a new minimum or maximum is found in a min-max test.
  - 2) a stable reading is captured in reading hold.
  - 3) a limit is exceeded in a limit test.
  - 4) a forward-biased diode is measured in the diode test function.
- Disabling the beeper has *no effect* on the tone generated when:
  - 1) an error is generated.
  - 2) the continuity threshold is exceeded.
  - 3) you turn off the front-panel menu.

*Turning off the beeper does not disable the key click generated when you press a front-panel key.*

- The beeper state is stored in *non-volatile* memory, and *does not* change when power has been off or after a remote interface reset. The beeper is enabled when the multimeter is shipped from the factory.
- *Front-Panel Operation:*

6: BEEP (SYS MENU)

- *Remote Interface Operation:*

SYSTEM:BEEPer  
 SYSTEM:BEEPer:STATe {OFF|ON}      *issue a single beep immediately  
 disable/enable beeper state*

### Comma Separators

The multimeter can display readings on the front panel with or without a comma separator. *This feature is available only from the front panel.*

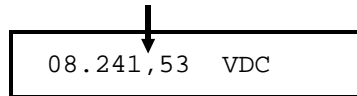

**With comma separator** (*factory setting*)

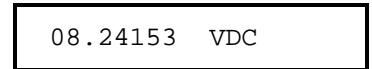

**Without comma separator**

- The display format is stored in *non-volatile* memory, and *does not* change when power has been off or after a remote interface reset. The comma separator is enabled when the multimeter is shipped from the factory.
- *Front-Panel Operation:*

7: COMMA (SYS MENU)

*See also "To Turn Off the Comma Separator," on page 37.*

### Firmware Revision Query

The multimeter has three microprocessors for control of various internal systems. You can query the multimeter to determine which revision of firmware is installed for each microprocessor.

- The multimeter returns three numbers. The first number is the firmware revision number for the measurement processor; the second is for the input/output processor; and the third is for the front-panel processor.
- *Front-Panel Operation:*

8: REVISION (SYS MENU)

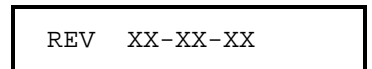

- *Remote Interface Operation:*

\*IDN? returns "HEWLETT-PACKARD,34401A,0,XX-XX-XX"

*Be sure to dimension a string variable with at least 35 characters.*

### **SCPI Language Version Query**

The multimeter complies with the rules and regulations of the present version of SCPI (Standard Commands for Programmable Instruments). You can determine the SCPI version with which the multimeter is in compliance by sending a command from the remote interface.

*You cannot query the SCPI version from the front panel.*

- The following command returns the SCPI version.

```
SYSTem:VERSion?
```

*Returns a string in the form "YYYY.V" where the "Y's" represent the year of the version, and the "V" represents a version number for that year (for example, 1991.0).*



---

## Remote Interface Configuration

This section gives information on configuring the remote interface. For additional information, see chapter 4, “Remote Interface Reference,” starting on page 103.

### GPIB Address

Each device on the GPIB (IEEE-488) interface must have a unique address. You can set the multimeter’s address to any value between 0 and 31. The address is set to “22” when the multimeter is shipped from the factory. The GPIB address is displayed at power-on.

*The GPIB address can be set only from the front-panel.*

- The address is stored in *non-volatile* memory, and *does not* change when power has been off or after a remote interface reset.
- You can set the address to “31” which is the *talk only* mode. In this mode, the multimeter can output readings directly to a printer without being addressed by a bus controller (over either GPIB or RS-232). For proper operation, make sure your printer is configured in the *listen always* mode. Address 31 is not a valid address if you are operating the multimeter from the GPIB interface with a bus controller.

If you select the RS-232 interface and then set the GPIB address to the talk only address (31), the multimeter will *send* readings over the RS-232 interface when in the local mode.

- If you select the RS-232 interface and then set the GPIB address to the talk only address (31), the multimeter will *send* readings over the RS-232 interface when in the local mode.
- Your GPIB bus controller has its own address. Be sure to avoid using the bus controller’s address for *any* instrument on the interface bus. Agilent controllers generally use address “21”.
- *Front-Panel Operation:*

1: GPIB ADDR (I/O MENU)

*See also “To Set the GPIB Address,” on page 161.*

### **Remote Interface Selection**

The multimeter is shipped with both an GPIB (IEEE-488) interface and an RS-232 interface. Only one interface can be enabled at a time. The GPIB interface is selected when the multimeter is shipped from the factory.

*The remote interface can be set only from the front-panel.*

- The interface selection is stored in *non-volatile* memory, and *does not* change when power has been off or after a remote interface reset.
- If you select the GPIB interface, you must select a unique address for the multimeter. The GPIB address is displayed when you turn on the multimeter.
- If you select the RS-232 interface, you must set the baud rate and parity for the multimeter. “RS-232” is displayed when you turn on the multimeter.
- If you select the RS-232 interface and then set the GPIB address to the talk only address (31), the multimeter will *send* readings over the RS-232 interface when in the local mode.
- There are certain restrictions to be aware of when you are selecting the remote interface (see also “Programming Language Selection,” on page 94). The only programming language supported on RS-232 is SCPI.

	<b>GPIB / 488</b>	<b>RS-232</b>
SCPI Language	X	X
3478A Language	X	Not allowed
Fluke 8840A Language	X	Not allowed

- *Front-Panel Operation:*

2: INTERFACE (I/O MENU)

*See also “To Select the Remote Interface,” on page 162.*

### **Baud Rate Selection (RS-232)**

You can select one of six baud rates for RS-232 operation. The rate is set to 9600 baud when the multimeter is shipped from the factory.

*The baud rate can be set only from the front-panel.*

- Select one of the following: 300, 600, 1200, 2400, 4800, or **9600** baud (factory setting).
- The baud rate selection is stored in *non-volatile* memory, and *does not* change when power has been off or after a remote interface reset.
- *Front-Panel Operation:*

3: BAUD RATE (I/O MENU)

*See also "To Set the Baud Rate," on page 163.*

### **Parity Selection (RS-232)**

You can select the parity for RS-232 operation. The multimeter is configured for even parity with 7 data bits when shipped from the factory.

*The parity can be set only from the front-panel.*

- Select one of the following: None (8 data bits), **Even** (7 data bits), or Odd (7 data bits). When you set the parity, you are indirectly setting the number of data bits.
- The parity selection is stored in *non-volatile* memory, and *does not* change when power has been off or after a remote interface reset.
- *Front-Panel Operation:*

4: PARITY (I/O MENU)

*See also "To Set the Parity," on page 164.*

## **Programming Language Selection**

You can select one of three languages to program the multimeter from the selected remote interface. The language is SCPI when the multimeter is shipped from the factory.

- Select one of the following: **SCPI**, Agilent 3478A, or Fluke 8840A.
- The language selection is stored in *non-volatile* memory, and *does not* change when power has been off or after a remote interface reset.
- There are certain restrictions to be aware of when you are selecting the interface language (see also “Remote Interface Selection,” on page 92). The Agilent 3478A and Fluke 8840A/8842A languages *are not* supported on the RS-232 interface.

	<b>GPIB / 488</b>	<b>RS-232</b>
SCPI Language	X	X
3478A Language	X	Not allowed
Fluke 8840A Language	X	Not allowed

- *Front-Panel Operation:*

5: LANGUAGE (I/O MENU)

*See also “To Select the Programming Language,” on page 165.*

- *Remote Interface Operation:*

L1     *select SCPI language*  
L2     *select Agilent 3478A language*  
L3     *select Fluke 8840A language*

---

## Calibration Overview

This section gives a brief introduction to the calibration features of the multimeter. For a more detailed discussion of the calibration procedures, see chapter 4 in the *Service Guide*.

### Calibration Security

This feature allows you to enter a security code to prevent accidental or unauthorized calibrations of the multimeter. When you first receive your multimeter, it is secured. Before you can calibrate the multimeter, you must unsecure it by entering the correct security code.

- The security code is set to “HP034401” when the multimeter is shipped from the factory. The security code is stored in *non-volatile* memory, and *does not* change when power has been off or after a remote interface reset.
- To secure the multimeter from the remote interface, the security code may contain up to 12 alphanumeric characters as shown below. The first character *must* be a letter, but the remaining characters can be letters or numbers. You do not have to use all 12 characters but the first character must always be a letter.

A \_ \_ \_ \_ \_ \_ \_ \_ \_ \_ \_ \_ (12 characters)

- To secure the multimeter from the remote interface so that it can be unsecured from the front panel, use the eight-character format shown below. The first two characters must be “HP” and the remaining characters must be numbers. Only the last six characters are recognized from the front panel, but all eight characters are required. (To unsecure the multimeter from the front panel, omit the “HP” and enter the remaining numbers as shown on the following pages.)

H P \_ \_ \_ \_ \_ \_ (8 characters)

*If you forget your security code, you can disable the security feature by adding a jumper inside the multimeter, and then entering a new code. See the Service Guide for more information.*

**Calibration Overview****Calibration Security***(continued)*

***To Unsecure for Calibration*** You can unsecure the multimeter for calibration either from the front panel or remote interface. The multimeter is secured when shipped from the factory, and the security code is set to “HP034401”.

- *Front-Panel Operation:*

```
1: SECURED (CAL MENU)
```

If the multimeter is secured, you will see the above command when you go into the CAL MENU. (If you move across the “commands” level in the menu, you will notice that the “2: CALIBRATE” command is “hidden” if the multimeter is secured.) To unsecure the multimeter, select the “parameter” level of the SECURED command, enter the security code, then press Menu Enter.

```
^000000 CODE
```

When you go to the “commands” level in the CAL MENU again, you will notice that the multimeter is unsecured. Notice also that the “2: CALIBRATE” command is no longer hidden and you can perform a calibration.

```
1: UNSECURED
```

- *Remote Interface Operation:*

```
CALibration:SECure:STATE {OFF|ON} , <code>
```

To unsecure the multimeter, send the above command with the same code used to secure. For example,

```
"CAL:SEC:STAT OFF,HP034401"
```

**Calibration Overview**

**To Secure Against Calibration** You can secure the multimeter against calibration either from the front panel or remote interface. The multimeter is secured when shipped from the factory, and the security code is set to “HP034401”.

*Make sure you have read the security code rules on page 95 before attempting to secure the multimeter.*

- *Front-Panel Operation:*

1: UNSECURED (CAL MENU)

If the multimeter is unsecured, you will see the above command when you go into the CAL MENU. To secure the multimeter, select the “parameter” level of the UNSECURED command, enter the security code, then press Menu Enter.

^000000 CODE

When you go to the “commands” level in the CAL MENU again, you will notice that the multimeter is secured. Notice also that the “2: CALIBRATE” command is now hidden and you cannot perform a calibration.

1: SECURED

- *Remote Interface Operation:*

CALibration:SECure:STAtE {OFF|ON} , <code>

To secure the multimeter, send the above command with the same code as used to unsecure. For example,

"CAL:SEC:STAT ON,HP034401"

**Calibration Overview****Calibration Security**  
(continued)

**To Change the Security Code** To change the security code, you must first unsecure the multimeter, and then enter a new code. Make sure you have read the security code rules on page 95 before attempting to secure the multimeter.

- *Front-Panel Operation:* To change the security code, first make sure that the multimeter is unsecured. Select the “parameter” level of the UNSECURED command, enter the new security code, then press Menu Enter. Changing the code from the front panel also changes the code as seen from the remote interface.
- *Remote Interface Operation:*

```
CALibration:SECure:CODE <new code>
```

To change the security code, first unsecure the multimeter using the old security code. Then, enter the new code. For example,

```
CAL:SEC:STAT OFF, HP034401    unsecure with old code
CAL:SEC:CODE ZZ010443        enter new code
```

**Calibration Count**

You can determine the number of times that your multimeter has been calibrated. Your multimeter was calibrated before it left the factory. When you receive your multimeter, read the count to determine its initial value.

- The calibration count is stored in *non-volatile* memory, and *does not* change when power has been off or after a remote interface reset.
- The calibration count increments up to a maximum of 32,767 after which it wraps-around to 0. Since the value increments by one for each calibration point, a complete calibration increases the value by several counts.
- *Front-Panel Operation:*

```
3: CAL COUNT (CAL MENU)
```

- *Remote Interface Operation:*

```
CALibration:COUNT?
```



**Calibration Overview****Calibration Message**

You can use the calibration message feature to record calibration information about your multimeter. For example, you can store such information as the last calibration date, the next calibration due date, the multimeter's serial number, or even the name and phone number of the person to contact for a new calibration.

*You can record information in the calibration message only from the remote interface. However, you can read the message from either the front-panel menu or the remote interface.*

- The calibration message may contain up to 40 characters. However, the multimeter can display only 12 characters of the message on the front panel (additional characters are truncated).
- The calibration message is stored in *non-volatile* memory, and *does not* change when power has been off or after a remote interface reset.
- *Front-Panel Operation:*

4: MESSAGE (CAL MENU) *read the cal message*

- *Remote Interface Operation:*

CALibration:STRing <quoted string> *store the cal message*

The following command string shows how to store a calibration message.

```
"CAL:STR 'CAL 2-1-96'"
```

## Operator Maintenance

This section describes how to replace the power-line and current fuses. If you need additional information about replacing parts or repairing the multimeter, see the *Service Guide*.

### To Replace the Power-Line Fuse

The power-line fuse is located within the multimeter's fuse-holder assembly on the rear panel (see also page 15). See the rear panel of the multimeter for the proper fuse rating. To replace the 250 mA T fuse, order Agilent part number 2110-0817.

### To Replace the Current Input Fuses

The front and rear current input terminals are protected by two series fuses. The first fuse is a 3A, 250 Vac, fast-blow fuse and is located on the rear panel. To replace this fuse, order Agilent part number 2110-0780.

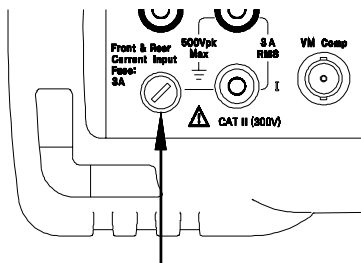

With a small flatblade screwdriver, push in on the fuse cap and rotate it counterclockwise. Remove the fuse cap and fuse.

A second fuse is located inside the multimeter to provide an additional level of current protection. This fuse is a 7A, 250 Vac, high-interrupt rated fuse (Agilent part number 2110-0614). To replace this fuse, you must remove the multimeter's case by loosening three screws. See the *Service Guide* for more information on disassembling the multimeter.

## Power-On and Reset State

The parameters marked with a bullet ( • ) are stored in *non-volatile* memory. The factory settings are shown.

*For your convenience, this table is duplicated on the rear cover of this manual and on the Quick Reference Card.*

<b>Measurement Configuration</b>	<b>Power-On/Reset State</b>
AC Filter	20 Hz (medium filter)
Autozero	On
• Continuity Threshold Function	• 10 $\Omega$
Input Resistance	DC volts
Integration Time	10 M $\Omega$ ( <i>fixed for all dcv ranges</i> )
Range	10 PLCs
Resolution	Autorange
	5½ digits, slow mode
<b>Math Operations</b>	<b>Power-On/Reset State</b>
Math State, Function	Off, Null
Math Registers	All registers are cleared
• dBm Reference Resistance	• 600 $\Omega$
<b>Triggering Operations</b>	<b>Power-On/Reset State</b>
Reading Hold Threshold	0.10% of range
Samples Per Trigger	1 sample
Trigger Delay	Automatic Delay
Trigger Source	Auto Trigger
<b>System-Related Operations</b>	<b>Power-On/Reset State</b>
• Beeper Mode	• On
• Comma Separators	• On
Display Mode	On
Reading Memory	Off (cleared)
<b>Input/Output Configuration</b>	<b>Power-On/Reset State</b>
• Baud Rate	• 9600 baud
• GPIB Address	• 22
• Interface	• GPIB (IEEE-488)
• Language	• SCPI
• Parity	• Even (7 data bits)
<b>Calibration</b>	<b>Power-On/Reset State</b>
• Calibration State	• Secured





---

## Remote Interface Reference

---

# Remote Interface Reference

- Command Summary, *starting on page 105*
-  > • Simplified Programming Overview, *starting on page 112*
- The MEASure? and CONFIgure Commands, *starting on page 117*
- Measurement Configuration Commands, *starting on page 121*
- Math Operation Commands, *starting on page 124*
- Triggering, *starting on page 127*
- Triggering Commands, *starting on page 130*
- System-Related Commands, *starting on page 132*
- The SCPI Status Model, *starting on page 134*
- Status Reporting Commands, *starting on page 144*
- Calibration Commands, *on page 146*
- RS-232 Interface Configuration, *starting on page 148*
- RS-232 Interface Commands, *on page 153*
-  > • An Introduction to the SCPI Language, *starting on page 154*
- Output Data Formats, *on page 159*
- Using Device Clear to Halt Measurements, *on page 160*
- TALK ONLY for Printers, *on page 160*
- To Set the GPIB Address, *on page 161*
- To Select the Remote Interface, *on page 162*
- To Set the Baud Rate, *on page 163*
- To Set the Parity, *on page 164*
- To Select the Programming Language, *on page 165*
- Alternate Programming Language Compatibility, *starting on page 166*
- SCPI Compliance Information, *on page 168*
- IEEE-488 Compliance Information, *on page 169*



*If you are a first-time user of the SCPI language, you may want to refer to these sections to become familiar with the language before attempting to program the multimeter.*

---

## Command Summary

This section summarizes the SCPI (*Standard Commands for Programmable Instruments*) commands available to program the multimeter. Refer to the later sections in this chapter for more complete details on each command.

*Throughout this manual, the following conventions are used for SCPI command syntax. Square brackets ( [ ] ) indicate optional keywords or parameters. Braces ( { } ) enclose parameters within a command string. Triangle brackets ( < > ) indicate that you must substitute a value for the enclosed parameter.*



First-time  
SCPI users,  
see page 154.

### The MEASure? and CONFIgure Commands

(see page 117 for more information)

#### MEASure

```
:VOLTage:DC? {<range>|MIN|MAX|DEF}, {<resolution>|MIN|MAX|DEF}
:VOLTage:DC:RATio? {<range>|MIN|MAX|DEF}, {<resolution>|MIN|MAX|DEF}
:VOLTage:AC? {<range>|MIN|MAX|DEF}, {<resolution>|MIN|MAX|DEF}
:CURRent:DC? {<range>|MIN|MAX|DEF}, {<resolution>|MIN|MAX|DEF}
:CURRent:AC? {<range>|MIN|MAX|DEF}, {<resolution>|MIN|MAX|DEF}
:RESistance? {<range>|MIN|MAX|DEF}, {<resolution>|MIN|MAX|DEF}
:FRESistance? {<range>|MIN|MAX|DEF}, {<resolution>|MIN|MAX|DEF}
:FREQuency? {<range>|MIN|MAX|DEF}, {<resolution>|MIN|MAX|DEF}
:PERiod? {<range>|MIN|MAX|DEF}, {<resolution>|MIN|MAX|DEF}
:CONTinuity?
:DIODE?
```

#### CONFIgure

```
:VOLTage:DC {<range>|MIN|MAX|DEF}, {<resolution>|MIN|MAX|DEF}
:VOLTage:DC:RATio {<range>|MIN|MAX|DEF}, {<resolution>|MIN|MAX|DEF}
:VOLTage:AC {<range>|MIN|MAX|DEF}, {<resolution>|MIN|MAX|DEF}
:CURRent:DC {<range>|MIN|MAX|DEF}, {<resolution>|MIN|MAX|DEF}
:CURRent:AC {<range>|MIN|MAX|DEF}, {<resolution>|MIN|MAX|DEF}
:RESistance {<range>|MIN|MAX|DEF}, {<resolution>|MIN|MAX|DEF}
:FRESistance {<range>|MIN|MAX|DEF}, {<resolution>|MIN|MAX|DEF}
:FREQuency {<range>|MIN|MAX|DEF}, {<resolution>|MIN|MAX|DEF}
:PERiod {<range>|MIN|MAX|DEF}, {<resolution>|MIN|MAX|DEF}
:CONTinuity
:DIODE
```

CONFIgure?

**Measurement Configuration Commands**

*(see page 121 for more information)*

```
[SENSe:]
FUNction "VOLTage:DC"
FUNction "VOLTage:DC:RATio"
FUNction "VOLTage:AC"
FUNction "CURRent:DC"
FUNction "CURRent:AC"
FUNction "RESistance"      (2-wire ohms)
FUNction "FRESistance"    (4-wire ohms)
FUNction "FREquency"
FUNction "PERiod"
FUNction "CONTinuity"
FUNction "DIODE"
FUNction?

[SENSe:]
VOLTage:DC:RANGe {<range>|MINimum|MAXimum}
VOLTage:DC:RANGe? [MINimum|MAXimum]
VOLTage:AC:RANGe {<range>|MINimum|MAXimum}
VOLTage:AC:RANGe? [MINimum|MAXimum]
CURRent:DC:RANGe {<range>|MINimum|MAXimum}
CURRent:DC:RANGe? [MINimum|MAXimum]
CURRent:AC:RANGe {<range>|MINimum|MAXimum}
CURRent:AC:RANGe? [MINimum|MAXimum]
RESistance:RANGe {<range>|MINimum|MAXimum}
RESistance:RANGe? [MINimum|MAXimum]
FRESistance:RANGe {<range>|MINimum|MAXimum}
FRESistance:RANGe? [MINimum|MAXimum]
FREquency:VOLTage:RANGe {<range>|MINimum|MAXimum}
FREquency:VOLTage:RANGe? [MINimum|MAXimum]
PERiod:VOLTage:RANGe {<range>|MINimum|MAXimum}
PERiod:VOLTage:RANGe? [MINimum|MAXimum]

[SENSe:]
VOLTage:DC:RANGe:AUTO {OFF|ON}
VOLTage:DC:RANGe:AUTO?
VOLTage:AC:RANGe:AUTO {OFF|ON}
VOLTage:AC:RANGe:AUTO?
CURRent:DC:RANGe:AUTO {OFF|ON}
CURRent:DC:RANGe:AUTO?
CURRent:AC:RANGe:AUTO {OFF|ON}
CURRent:AC:RANGe:AUTO?
RESistance:RANGe:AUTO {OFF|ON}
RESistance:RANGe:AUTO?
FRESistance:RANGe:AUTO {OFF|ON}
FRESistance:RANGe:AUTO?
FREquency:VOLTage:RANGe:AUTO {OFF|ON}
FREquency:VOLTage:RANGe:AUTO?
PERiod:VOLTage:RANGe:AUTO {OFF|ON}
PERiod:VOLTage:RANGe:AUTO?
```

*Default parameters are shown in bold.*



**Measurement Configuration Commands**

*(continued)*

```
[SENSe:]
  VOLTage:DC:RESolution {<resolution>|MINimum|MAXimum}
  VOLTage:DC:RESolution? [MINimum|MAXimum]
  VOLTage:AC:RESolution {<resolution>|MINimum|MAXimum}
  VOLTage:AC:RESolution? [MINimum|MAXimum]
  CURRent:DC:RESolution {<resolution>|MINimum|MAXimum}
  CURRent:DC:RESolution? [MINimum|MAXimum]
  CURRent:AC:RESolution {<resolution>|MINimum|MAXimum}
  CURRent:AC:RESolution? [MINimum|MAXimum]
  RESistance:RESolution {<resolution>|MINimum|MAXimum}
  RESistance:RESolution? [MINimum|MAXimum]
  FRESistance:RESolution {<resolution>|MINimum|MAXimum}
  FRESistance:RESolution? [MINimum|MAXimum]

[SENSe:]
  VOLTage:DC:NPLCycles {0.02|0.2|1|10|100|MINimum|MAXimum}
  VOLTage:DC:NPLCycles? [MINimum|MAXimum]
  CURRent:DC:NPLCycles {0.02|0.2|1|10|100|MINimum|MAXimum}
  CURRent:DC:NPLCycles? [MINimum|MAXimum]
  RESistance:NPLCycles {0.02|0.2|1|10|100|MINimum|MAXimum}
  RESistance:NPLCycles? [MINimum|MAXimum]
  FRESistance:NPLCycles {0.02|0.2|1|10|100|MINimum|MAXimum}
  FRESistance:NPLCycles? [MINimum|MAXimum]

[SENSe:]
  FREQuency:APERTure {0.01|0.1|1|MINimum|MAXimum}
  FREQuency:APERTure? [MINimum|MAXimum]
  PERiod:APERTure {0.01|0.1|1|MINimum|MAXimum}
  PERiod:APERTure? [MINimum|MAXimum]

[SENSe:]
  DETector:BANDwidth {3|20|200|MINimum|MAXimum}
  DETector:BANDwidth? [MINimum|MAXimum]

[SENSe:]
  ZERO:AUTO {OFF|ONCE|ON}
  ZERO:AUTO?

INPut
  :IMPedance:AUTO {OFF|ON}
  :IMPedance:AUTO?

ROUTE:TERMinals?
```

*Default parameters are shown in bold.*

## Chapter 4 Remote Interface Reference

### Command Summary

#### Math Operation Commands

*(see page 124 for more information)*

```
CALCulate
:FUNCTION {NULL|DB|DBM|AVERAGE|LIMIT}
:FUNCTION?
:STATE {OFF|ON}
:STATE?

CALCulate
:AVERAGE:MINimum?
:AVERAGE:MAXimum?
:AVERAGE:AVERAGE?
:AVERAGE:COUNT?

CALCulate
:NULL:OFFSET {<value>|MINimum|MAXimum}
:NULL:OFFSET? [MINimum|MAXimum]

CALCulate
:DB:REFERENCE {<value>|MINimum|MAXimum}
:DB:REFERENCE? [MINimum|MAXimum]

CALCulate
:DBM:REFERENCE {<value>|MINimum|MAXimum}
:DBM:REFERENCE? [MINimum|MAXimum]

CALCulate
:LIMIT:LOWER {<value>|MINimum|MAXimum}
:LIMIT:LOWER? [MINimum|MAXimum]
:LIMIT:UPPER {<value>|MINimum|MAXimum}
:LIMIT:UPPER? [MINimum|MAXimum]

DATA:FEED RDG_STORE, {"CALCulate"|" "}
DATA:FEED?
```

## Chapter 4 Remote Interface Reference

### Command Summary

#### Triggering Commands

*(see page 127 for more information)*

INITiate

READ?

TRIGger

:SOURCE {BUS | **IMMEDIATE** | EXTERNAL}  
:SOURCE?

TRIGger

:DELAY {<seconds> | MINimum | MAXimum}  
:DELAY? [MINimum | MAXimum]

TRIGger

:DELAY:AUTO {OFF | ON}  
:DELAY:AUTO?

SAMPLE

:COUNT {<value> | MINimum | MAXimum}  
:COUNT? [MINimum | MAXimum]

TRIGger

:COUNT {<value> | MINimum | MAXimum | INFinite}  
:COUNT? [MINimum | MAXimum]

#### System-Related Commands

*(see page 132 for more information)*

FETCH?

READ?

DISPlay {OFF | **ON**}  
DISPlay?

DISPlay

:TEXT <quoted string>  
:TEXT?  
:TEXT:CLEAr

SYSTEM

:BEEPer  
:BEEPer:STATE {OFF | ON}  
:BEEPer:STATE?

SYSTEM:ERRor?

SYSTEM:VERSion?

DATA:POINTs?

\*RST

\*TST?

\*IDN?

L1

L2

L3

*Default parameters are shown in bold.*

# Chapter 4 Remote Interface Reference

## Command Summary

### Status Reporting Commands

(see page 144 for more information)

SYSTem:ERRor?

STATus

:QUESTionable:ENABle <enable value>  
 :QUESTionable:ENABle?  
 :QUESTionable:EVENT?

STATus:PRESet

\*CLS

\*ESE <enable value>

\*ESE?

\*ESR?

\*OPC

\*OPC?

\*PSC {0|1}

\*PSC?

\*SRE <enable value>

\*SRE?

\*STB?

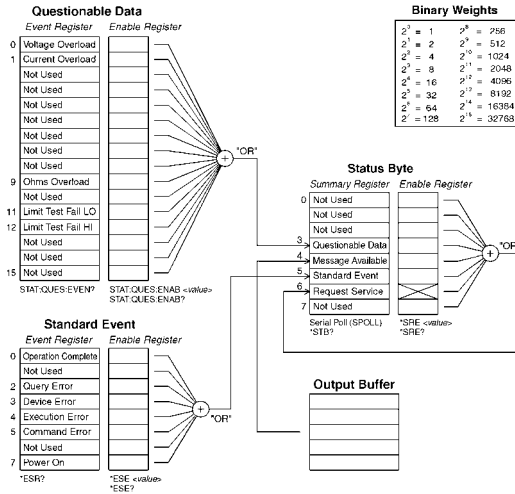

### Calibration Commands

(see page 146 for more information)

CALibration?

CALibration:COUNT?

CALibration

:SECure:CODE <new code>  
 :SECure:STATe {OFF|ON}, <code>  
 :SECure:STATe?

CALibration

:STRing <quoted string>  
 :STRing?

CALibration

:VALue <value>

Default parameters are shown in bold.

## Chapter 4 Remote Interface Reference

### Command Summary

#### RS-232 Interface Commands

*(see page 148 for more information)*

SYSTem:LOCal

SYSTem:REMOte

SYSTem:RWLock

#### IEEE-488.2 Common Commands

*(see page 169 for more information)*

\*CLS

\*ESE *<enable value>*

\*ESE?

\*ESR?

\*IDN?

\*OPC

\*OPC?

\*PSC {0|1}

\*PSC?

\*RST

\*SRE *<enable value>*

\*SRE?

\*STB?

\*TRG

\*TST?

*Default parameters are shown in bold.*



First-time  
SCPI users,  
see page 154.

---

## Simplified Programming Overview

You can program the multimeter to take measurements from the remote interface using the following simple seven-step sequence.

1. Place the multimeter in a known state (often the *reset* state).
2. Change the multimeter's settings to achieve the desired configuration.
3. Set-up the triggering conditions.
4. Initiate or arm the multimeter for a measurement.
5. Trigger the multimeter to make a measurement.
6. Retrieve the readings from the output buffer or internal memory.
7. Read the measured data into your bus controller.

The `MEASure?` and `CONFigure` commands provide the most straightforward method to program the multimeter for measurements. You can select the measurement function, range, and resolution all in one command. The multimeter automatically *presets* other measurement parameters (ac filter, autozero, trigger count, etc.) to default values as shown below.

### MEASure? and CONFigure Preset States

Command	MEASure? and CONFigure Setting
AC Filter (DET:BAND)	20 Hz (medium filter)
Autozero (ZERO:AUTO)	OFF if resolution setting results in $NPLC < 1$ ; ON if resolution setting results in $NPLC \geq 1$
Input Resistance (INP:IMP:AUTO)	OFF (fixed at 10 M $\Omega$ for all dc voltage ranges)
Samples per Trigger (SAMP:COUN)	1 sample
Trigger Count (TRIG:COUN)	1 trigger
Trigger Delay (TRIG:DEL)	Automatic delay
Trigger Source (TRIG:SOUR)	Immediate
Math Function (CALCulate subsystem)	OFF

### **Using the MEASure? Command**

The easiest way to program the multimeter for measurements is by using the `MEASure?` command. However, this command does not offer much flexibility. When you execute the command, the multimeter *presets* the best settings for the requested configuration and immediately performs the measurement. You cannot change any settings (other than function, range, and resolution) before the measurement is taken. The results are sent to the output buffer.

*Sending the MEASure? command is the same as sending a CONFigure command followed immediately by a READ? command.*

### **Using the CONFigure Command**

For a little more programming flexibility, use the `CONFigure` command. When you execute the command, the multimeter *presets* the best settings for the requested configuration (like the `MEASure?` command). However, the measurement *is not* automatically started and you can change measurement parameters before making measurements. This allows you to “incrementally” change the multimeter’s configuration from the *preset* conditions. The multimeter offers a variety of low-level commands in the `INPut`, `SENSe`, `CALCulate`, and `TRIGger` subsystems. (You can use the `SENSe:FUNCTION` command to change the measurement function without using `MEASure?` or `CONFigure`.)

*Use the INITiate or READ? command to initiate the measurement.*

### **Using the *range* and *resolution* Parameters**

With the MEASure? and CONFigure commands, you can select the measurement function, range, and resolution all in one command. Use the *range* parameter to specify the expected value of the input signal. The multimeter then selects the correct measurement range.

For frequency and period measurements, the multimeter uses one “range” for all inputs between 3 Hz and 300 kHz. The range parameter is required only to specify the resolution. Therefore, it is not necessary to send a new command for each new frequency to be measured.

Use the *resolution* parameter to specify the desired resolution for the measurement. Specify the resolution in the same units as the measurement function, *not in number of digits*. For example, for dc volts, specify the resolution in volts. For frequency, specify the resolution in hertz.

*You must specify a range to use the resolution parameter.*

### **Using the READ? Command**

The READ? command changes the state of the trigger system from the “idle” state to the “wait-for-trigger” state. Measurements will begin when the specified trigger conditions are satisfied following the receipt of the READ? command. Readings are sent *immediately* to the output buffer. You *must* enter the reading data into your bus controller or the multimeter will stop making measurements when the output buffer fills. Readings *are not* stored in the multimeter’s internal memory when using the READ? command.

*Sending the READ? command is like sending the INITiate command followed immediately by the FETCh? command, except readings are not buffered internally.*



---

**Caution**

*If you send two query commands without reading the response from the first, and then attempt to read the second response, you may receive some data from the first response followed by the complete second response. To avoid this, do not send a query command without reading the response. When you cannot avoid this situation, send a device clear before sending the second query command.*

---

### Using the INITiate and FETCh? Commands

The INITiate and FETCh? commands provide the lowest level of control (with the most flexibility) of measurement triggering and reading retrieval. Use the INITiate command after you have configured the multimeter for the measurement. This changes the state of the triggering system from the “idle” state to the “wait-for-trigger” state. Measurements will begin when the specified trigger conditions are satisfied after the INITiate command is received. The readings *are* placed in the multimeter’s internal memory (up to 512 readings can be stored). Readings *are stored* in memory until you are able to retrieve them.

Use the FETCh? command to transfer the readings from the multimeter’s internal memory to the multimeter’s output buffer where you can read them into your bus controller.

---

**MEASure?  
Example**

The following program segment shows how to use the MEASure? command to make a measurement. This example configures the multimeter for dc voltage measurements, automatically places the multimeter in the “wait-for-trigger” state, internally triggers the multimeter to take one reading, and then sends the reading to the output buffer.

```
MEAS:VOLT:DC? 10,0.003  
bus enter statement
```

This is the simplest way to take a reading. However, you do not have any flexibility with MEASure? to set the trigger count, sample count, trigger delay, etc. All measurement parameters except function, range, and resolution are preset for you automatically (*see the table on page 112*).

---

**CONFigure  
Example**

The following program segment shows how to use the `READ?` command with `CONFigure` to make an externally-triggered measurement. The program configures the multimeter for dc voltage measurements. `CONFigure` does not place the multimeter in the “wait-for-trigger” state. The `READ?` command places the multimeter in the “wait-for-trigger” state, takes a reading when the *Ext Trig* terminal is pulsed, and sends the reading to the output buffer.

```
CONF:VOLT:DC 10, 0.003
TRIG:SOUR EXT
READ?
bus enter statement
```

---

**CONFigure  
Example**

The following program segment is similar to the program above but it uses `INITiate` to place the multimeter in the “wait-for-trigger” state. The `INITiate` command places the multimeter in the “wait-for-trigger” state, takes a reading when the *Ext Trig* terminal is pulsed, and sends the reading to the multimeter’s internal memory. The `FETCh?` command transfers the reading from internal memory to the output buffer.

```
CONF:VOLT:DC 10, 0.003
TRIG:SOUR EXT
INIT
FETC?
bus enter statement
```

Storing readings in memory using the `INITiate` command is faster than sending readings to the output buffer using the `READ?` command. The multimeter can store up to 512 readings in internal memory. If you configure the multimeter to take more than 512 readings (using the sample count and trigger count), and then send `INITiate`, a memory error is generated.

After you execute an `INITiate` command, no further commands are accepted until the measurement sequence is completed. However, if you select `TRIGger:SOURce BUS`, the multimeter will accept the `*TRG` command (bus trigger) or an IEEE-488 *Group Execute Trigger* message.

---

## The MEASure? and CONFigure Commands

See also "Measurement Configuration," starting on page 51 in chapter 3.

- For the *range* parameter, MIN selects the lowest range for the selected function; MAX selects the highest range; DEF selects autoranging.
- For the *resolution* parameter, specify the resolution in the same units as the measurement function, *not in number of digits*. MIN selects the smallest value accepted, which gives the best resolution; MAX selects the largest value accepted, which gives the least resolution; DEF selects the default resolution which is 5½ digits slow (10 PLC).

**Note:** You must specify a **range** to use the **resolution** parameter.

**MEASure:VOLTage:DC?** {<range>|MIN|MAX|DEF}, {<resolution>|MIN|MAX|DEF}  
Preset and make a dc voltage measurement with the specified range and resolution. The reading is sent to the output buffer.

**MEASure:VOLTage:DC:RATio?** {<range>|MIN|MAX|DEF}, {<resolution>|MIN|MAX|DEF}  
Preset and make a dc:dc ratio measurement with the specified range and resolution. The reading is sent to the output buffer. For ratio measurements, the specified range applies to the signal connected to the **Input** terminals. Autoranging is automatically selected for reference voltage measurements on the **Sense** terminals.

**MEASure:VOLTage:AC?** {<range>|MIN|MAX|DEF}, {<resolution>|MIN|MAX|DEF}  
Preset and make an ac voltage measurement with the specified range and resolution. The reading is sent to the output buffer. For ac measurements, resolution is actually fixed at 6½ digits. The *resolution* parameter only affects the front-panel display.

**MEASure:CURRent:DC?** {<range>|MIN|MAX|DEF}, {<resolution>|MIN|MAX|DEF}  
Preset and make a dc current measurement with the specified range and resolution. The reading is sent to the output buffer.

**The MEASure? and CONFigure Commands**

**MEASure:CURRent:AC?** {<range>|MIN|MAX|DEF},{<resolution>|MIN|MAX|DEF}  
Preset and make an ac current measurement with the specified range and resolution. The reading is sent to the output buffer. For ac measurements, resolution is actually fixed at 6½ digits. The *resolution* parameter only affects the front-panel display.

**MEASure:RESistance?** {<range>|MIN|MAX|DEF},{<resolution>|MIN|MAX|DEF}  
Preset and make a 2-wire ohms measurement with the specified range and resolution. The reading is sent to the output buffer.

**MEASure:FRESistance?** {<range>|MIN|MAX|DEF},{<resolution>|MIN|MAX|DEF}  
Preset and make a 4-wire ohms measurement with the specified range and resolution. The reading is sent to the output buffer.

**MEASure:FREQuency?** {<range>|MIN|MAX|DEF},{<resolution>|MIN|MAX|DEF}  
Preset and make a frequency measurement with the specified range and resolution. The reading is sent to the output buffer. For frequency measurements, the multimeter uses one “range” for all inputs between 3 Hz and 300 kHz. With no input signal applied, frequency measurements return “0”.

**MEASure:PERiod?** {<range>|MIN|MAX|DEF},{<resolution>|MIN|MAX|DEF}  
Preset and make a period measurement with the specified range and resolution. The reading is sent to the output buffer. For period measurements, the multimeter uses one “range” for all inputs between 0.33 seconds and 3.3 μsec. With no input signal applied, period measurements return “0”.

**MEASure:CONTInuity?**  
Preset and make a continuity measurement. The reading is sent to the output buffer. The range and resolution are fixed for continuity tests (1 kΩ range and 5½ digits).

**MEASure:DIODE?**  
Preset and make a diode measurement. The reading is sent to the output buffer. The range and resolution are fixed for diode tests (1 Vdc range with 1 mA current source output and 5½ digits).

**CONFIgure:VOLTage:DC** {<range>|MIN|MAX|DEF}, {<resolution>|MIN|MAX|DEF}  
Preset and configure the multimeter for dc voltage measurements with the specified range and resolution. This command *does not* initiate the measurement.

**CONFIgure:VOLTage:DC:RATio** {<range>|MIN|MAX|DEF}, {<resolution>|MIN|MAX|DEF}  
Preset and configure the multimeter for dc:dc ratio measurements with the specified range and resolution. This command *does not* initiate the measurement. For ratio measurements, the specified range applies to the signal connected to the **Input** terminals. Autoranging is automatically selected for reference voltage measurements on the **Sense** terminals.

**CONFIgure:VOLTage:AC** {<range>|MIN|MAX|DEF}, {<resolution>|MIN|MAX|DEF}  
Preset and configure the multimeter for ac voltage measurements with the specified range and resolution. This command *does not* initiate the measurement. For ac measurements, resolution is actually fixed at 6½ digits. The *resolution* parameter only affects the front-panel display.

**CONFIgure:CURREnt:DC** {<range>|MIN|MAX|DEF}, {<resolution>|MIN|MAX|DEF}  
Preset and configure the multimeter for dc current measurements with the specified range and resolution. This command *does not* initiate the measurement.

**CONFIgure:CURREnt:AC** {<range>|MIN|MAX|DEF}, {<resolution>|MIN|MAX|DEF}  
Preset and configure the multimeter for ac current measurements with the specified range and resolution. This command *does not* initiate the measurement. For ac measurements, resolution is actually fixed at 6½ digits. The *resolution* parameter only affects the front-panel display.

**CONFIgure:RESistance** {<range>|MIN|MAX|DEF}, {<resolution>|MIN|MAX|DEF}  
Preset and configure the multimeter for 2-wire ohms measurements with the specified range and resolution. This command *does not* initiate the measurement.

**CONFIgure:FRESistance** {<range>|MIN|MAX|DEF}, {<resolution>|MIN|MAX|DEF}  
Preset and configure the multimeter for 4-wire ohms measurements with the specified range and resolution. This command *does not* initiate the measurement.

## The MEASure? and CONFigure Commands

**CONFigure:FREQuency** {<range>|MIN|MAX|DEF},{<resolution>|MIN|MAX|DEF}

Preset and configure a frequency measurement with the specified range and resolution. This command *does not* initiate the measurement.

For frequency measurements, the multimeter uses one “range” for all inputs between 3 Hz and 300 kHz. With no input signal applied, frequency measurements return “0”.

**CONFigure:PERiod** {<range>|MIN|MAX|DEF},{<resolution>|MIN|MAX|DEF}

Preset and configure a period measurement with the specified range and resolution. This command *does not* initiate the measurement.

For period measurements, the multimeter uses one “range” for all inputs between 0.33 seconds and 3.3  $\mu$ sec. With no input signal applied, period measurements return “0”.

**CONFigure:CONTinuity**

Preset and configure the multimeter for continuity measurements.

This command *does not* initiate the measurement. The range and resolution are fixed for continuity tests (1 k $\Omega$  range and 5½ digits).

**CONFigure:DIODE**

Preset and configure the multimeter for diode measurements.

This command *does not* initiate the measurement. The range and resolution are fixed for diode tests (1 Vdc range with 1 mA current source output and 5½ digits).

**CONFigure?**

Query the multimeter’s present configuration and return a quoted string.

---

## Measurement Configuration Commands

See also "Measurement Configuration," starting on page 51 in chapter 3.

### **FUNCTION** "<function>"

Select a measurement function. The function must be enclosed in quotes in the command string (FUNC "VOLT:DC"). Specify one of the following strings.

VOLTage:DC	FRESistance (4-wire ohms)
VOLTage:DC:RATio	FREQuency
VOLTage:AC	PERiod
CURRent:DC	CONTinuity
CURRent:AC	DIODE
RESistance (2-wire ohms)	

### **FUNCTION?**

Query the measurement function and return a quoted string.

<function>:RANGE {<range>|MINimum|MAXimum}

Select the range for the selected function. For frequency and period measurements, ranging applies to the signal's input voltage, *not* its frequency (use FREQuency:VOLTage or PERiod:VOLTage). MIN selects the lowest range for the selected function. MAX selects the highest range. *[Stored in volatile memory]*

<function>:RANGE? [MINimum|MAXimum]

Query the range for the selected function.

<function>:RANGE:AUTO {OFF|ON}

Disable or enable autoranging for the selected function. For frequency and period, use FREQuency:VOLTage or PERiod:VOLTage. Autorange thresholds: Down range at <10% of range; Up range at >120% of range. *[Stored in volatile memory]*

<function>:RANGE:AUTO?

Query the autorange setting. Returns "0" (OFF) or "1" (ON).

**<function>:RESolution** {<resolution>|MINimum|MAXimum}  
Select the resolution for the specified function (not valid for frequency, period, or ratio). Specify the resolution in the same units as the measurement function, *not in number of digits*. MIN selects the smallest value accepted, which gives the most resolution. MAX selects the largest value accepted which gives the least resolution. *[Stored in volatile memory]*

**<function>:RESolution?** [MINimum|MAXimum]  
Query the resolution for the selected function. For frequency or period measurements, the multimeter returns a resolution setting based upon a 3 Hz input frequency.

**<function>:NPLCycles** {0.02|0.2|1|10|100|MINimum|MAXimum}  
Select the integration time in number of power line cycles for the present function (the default is 10 PLC). This command is valid only for dc volts, ratio, dc current, 2-wire ohms, and 4-wire ohms. MIN = 0.02. MAX = 100. *[Stored in volatile memory]*

**<function>:NPLCycles?** [MINimum|MAXimum]  
Query the integration time for the selected function.

**FREquency:APERTure** {0.01|0.1|1|MINimum|MAXimum}  
Select the aperture time (or gate time) for frequency measurements (the default is 0.1 seconds). Specify 10 ms (4½ digits), **100 ms** (default; 5½ digits), or 1 second (6½ digits). MIN = 0.01 seconds. MAX = 1 second. *[Stored in volatile memory]*

**FREquency:APERTure?** [MINimum|MAXimum]  
Query the aperture time for frequency measurements.

**PERiod:APERTure** {0.01|0.1|1|MINimum|MAXimum}  
Select the aperture time (or gate time) for period measurements (the default is 0.1 seconds). Specify 10 ms (4½ digits), **100 ms** (default; 5½ digits), or 1 second (6½ digits). MIN = 0.01 seconds. MAX = 1 second. *[Stored in volatile memory]*

**PERiod:APERTure?** [MINimum|MAXimum]  
Query the aperture time for period measurements.



**[SENSE:]DETECTOR:BANDwidth** {3|20|200|MINimum|MAXimum}  
Specify the lowest frequency expected in the input signal. The multimeter selects the slow, medium (default), or fast ac filter based on the frequency you specify. MIN = 3 Hz. MAX = 200 Hz. *[Stored in volatile memory]*

**[SENSE:]DETECTOR:BANDwidth?** [MINimum|MAXimum]  
Query the ac filter. Returns "+3.000000E+00", "+2.000000E+01", or "+2.000000E+02".

**[SENSE:]ZERO:AUTO** {OFF|ONCE|ON}  
Disable or enable (default) the autozero mode. The OFF and ONCE parameters have a similar effect. Autozero OFF *does not* issue a new zero measurement until the next time the multimeter goes to the "wait-for-trigger" state. Autozero ONCE issues an immediate zero measurement. *[Stored in volatile memory]*

**[SENSE:]ZERO:AUTO?**  
Query the autozero mode. Returns "0" (OFF or ONCE) or "1" (ON).

**INPut:IMPedance:AUTO** {OFF|ON}  
Disable or enable the automatic input resistance mode for dc voltage measurements. With AUTO OFF (default), the input resistance is fixed at 10 M $\Omega$  for all ranges. With AUTO ON, the input resistance is set to >10 G $\Omega$  for the 100 mV, 1 V, and 10 V ranges. *[Stored in volatile memory]*

**INPut:IMPedance:AUTO?**  
Query the input resistance mode. Returns "0" (OFF) or "1" (ON).

**ROUTE:TERMinals?**  
Query the multimeter to determine if the front or rear input terminals are selected. Returns "FRON" or "REAR".

---

## Math Operation Commands

See also “Math Operations,” starting on page 63 in chapter 3.

There are five math operations available, only one of which can be enabled at a time. Each math operation performs a mathematical operation on each reading or stores data on a series of readings. The selected math operation remains in effect until you disable it, change functions, turn off the power, or perform a remote interface reset. The math operations use one or more internal registers. You can preset the values in some of the registers, while others hold the results of the math operation.

The following table shows the math/measurement function combinations allowed. Each “X” indicates an allowable combination. If you choose a math operation that is not allowed with the present measurement function, math is turned off. If you select a valid math operation and then change to one that is invalid, a “Settings conflict” error is generated over the remote interface. *For null and dB measurements, you must turn on the math operation before writing to their math registers.*

	DC V	AC V	DC I	AC I	$\Omega$ 2W	$\Omega$ 4W	Freq	Per	Cont	Diode	Ratio
Null	X	X	X	X	X	X	X	X			
Min-Max	X	X	X	X	X	X	X	X			X
dB	X	X									
dBm	X	X									
Limit	X	X	X	X	X	X	X	X			X

**CALCulate:FUNCTION** {NULL|DB|DBM|AVERAGE|LIMIT}

Select the math function. Only one function can be enabled at a time.

The default function is null. *[Stored in volatile memory]*

**CALCulate:FUNCTION?**

Query the present math function. Returns NULL, DB, DBM, AVER, or LIM.

**CALCulate:STATE** {OFF|ON}

Disable or enable the selected math function. *[Stored in volatile memory]*

**CALCulate:STATE?**

Query the state of the math function. Returns “0” (OFF) or “1” (ON).

**Math Operation Commands****CALCulate:AVERAge:MINimum?**

Read the minimum value found during a min-max operation. The multimeter clears the value when min-max is turned on, when power has been off, or after a remote interface reset. *[Stored in volatile memory]*

**CALCulate:AVERAge:MAXimum?**

Read the maximum value found during a min-max operation. The multimeter clears the value when min-max is turned on, when power has been off, or after a remote interface reset. *[Stored in volatile memory]*

**CALCulate:AVERAge:AVERAge?**

Read the average of all readings taken since min-max was enabled. The multimeter clears the value when min-max is turned on, when power has been off, or after a remote interface reset. *[Stored in volatile memory]*

**CALCulate:AVERAge:COUNT?**

Read the number of readings taken since min-max was enabled. The multimeter clears the value when min-max is turned on, when power has been off, or after a remote interface reset. *[Stored in volatile memory]*

**CALCulate:NULL:OFFSet {<value>|MINimum|MAXimum}**

Store a null value in the multimeter's Null Register. *You must turn on the math operation before writing to the math register.* You can set the null value to any number between 0 and  $\pm 120\%$  of the highest range, for the present function. MIN =  $-120\%$  of the highest range. MAX =  $120\%$  of the highest range. *[Stored in volatile memory]*

**CALCulate:NULL:OFFSet? [MINimum|MAXimum]**

Query the null value.

**CALCulate:DB:REfERence {<value>|MINimum|MAXimum}**

Store a relative value in the dB Relative Register. *You must turn on the math operation before writing to the math register.* You can set the relative value to any number between 0 dBm and  $\pm 200$  dBm. MIN =  $-200.00$  dBm. MAX =  $200.00$  dBm. *[Stored in volatile memory]*

**CALCulate:DB:REfERence? [MINimum|MAXimum]**

Query the dB relative value.

## Math Operation Commands

**CALCulate:DBM:REfERENCE** {<value>|MINimum|MAXimum}

Select the dBm reference value. Choose from: 50, 75, 93, 110, 124, 125, 135, 150, 250, 300, 500, **600**, 800, 900, 1000, 1200, or 8000 ohms.

MIN = 50 Ω. MAX = 8000 Ω. *[Stored in non-volatile memory]*

**CALCulate:DBM:REfERENCE?** [MINimum|MAXimum]

Query the dBm reference resistance.

**CALCulate:LIMit:LOWer** {<value>|MINimum|MAXimum}

Set the lower limit for limit testing. You can set the value to any number between 0 and ±120% of the highest range, for the present function.

MIN = -120% of the highest range. MAX = 120% of the highest range.

*[Stored in volatile memory]*

**CALCulate:LIMit:LOWer?** [MINimum|MAXimum]

Query the lower limit.

**CALCulate:LIMit:UPPer** {<value>|MINimum|MAXimum}

Set the lower limit for limit testing. You can set the value to any number between 0 and ±120% of the highest range, for the present function.

MIN = -120% of the highest range. MAX = 120% of the highest range.

*[Stored in volatile memory]*

**CALCulate:LIMit:UPPer?** [MINimum|MAXimum]

Query the upper limit.

**DATA:FEED RDG\_STORE, {"CALCulate"|" "}**

Selects whether readings taken using the INITiate command are stored in the multimeter's internal memory (default) or not stored at all.

In the default state (DATA:FEED RDG\_STORE, "CALC"), up to 512 readings are stored in memory when INITiate is executed.

The MEASure? and CONFigure commands automatically select "CALC".

With memory disabled (DATA:FEED RDG\_STORE, " "), readings taken using INITiate are not stored. This may be useful with the min-max operation since it allows you to determine an average of the readings without storing the individual values. An error will be generated if you attempt to transfer readings to the output buffer using the FETCh? command.

**DATA:FEED?**

Query the reading memory state. Returns "CALC" or " ".



*First-time  
SCPI users,  
see page 154.*

---

## Triggering

*See also “Triggering,” starting on page 71 in chapter 3.*

The multimeter’s triggering system allows you to generate triggers either manually or automatically, take multiple readings per trigger, and insert a delay before each reading. Normally, the multimeter will take one reading each time it receives a trigger, but you can specify multiple readings (up to 50,000) per trigger.

Triggering the multimeter from the remote interface is a multi-step process that offers triggering flexibility.

- First, you must configure the multimeter for the measurement by selecting the function, range, resolution, etc.
- Then, you must specify the source from which the multimeter will accept the trigger. The multimeter will accept a software (bus) trigger from the remote interface, a hardware trigger from the rear-panel *Ext Trig* (external trigger) terminal, or an immediate internal trigger.
- Then, you must make sure that the multimeter is ready to accept a trigger from the specified trigger source (this is called the *wait-for-trigger* state).

*The diagram on the next page shows the multimeter’s triggering system.*

**Triggering**

**Agilent 34401A Triggering System**

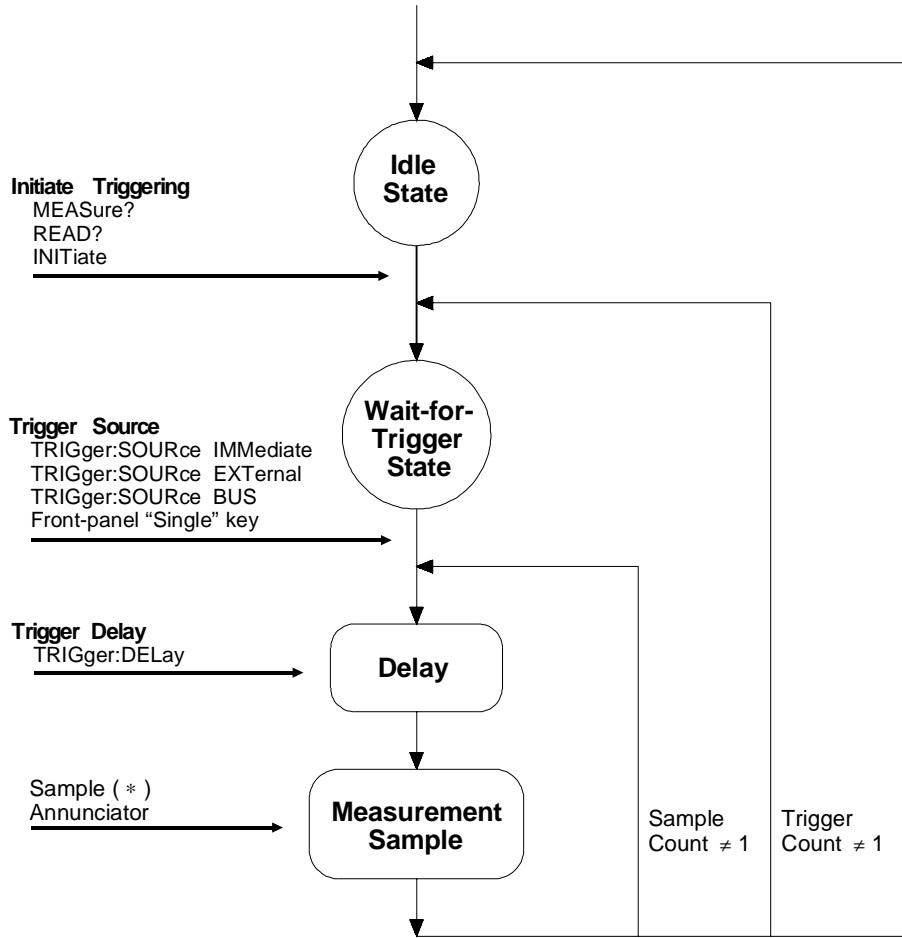

## Triggering

### The Wait-for-Trigger State

After you have configured the multimeter and selected a trigger source, you must place the multimeter in the *wait-for-trigger* state. A trigger will not be accepted until the multimeter is in this state. If a trigger signal is present, and if multimeter is in the “wait-for-trigger” state, the measurement sequence begins and readings are taken.

*The “wait-for-trigger” state is a term used primarily for remote interface operation. From the front panel, the multimeter is always in the “wait-for-trigger” state and will accept triggers at any time, unless a measurement is already in progress.*

You can place the multimeter in the “wait-for-trigger” state by executing any of the following commands from the remote interface.

```
MEASure?  
READ?  
INITiate
```

*The multimeter requires approximately 20 ms of set-up time after you send a command to change to the “wait-for-trigger” state. Any external triggers that occur during this set-up time are ignored.*

---

## Triggering Commands

See also “Triggering,” starting on page 71 in chapter 3.

### INITiate

Change the state of the triggering system from the “idle” state to the “wait-for-trigger” state. Measurements will begin when the specified trigger conditions are satisfied after the `INITiate` command is received. The readings are placed in the multimeter’s internal memory (up to 512 readings can be stored). Readings *are stored* in memory until you are able to retrieve them. Use the `FETCh?` command to retrieve reading results.

*A new command is available starting with firmware Revision 2 which allows you to take readings using `INITiate` without storing them in internal memory. This command may be useful with the min-max operation since it allows you to determine the average of a series of readings without storing the individual values.*

```
DATA:FEED RDG_STORE, " "           do not store readings
DATA:FEED RDG_STORE, "CALCulate"   store readings (default)
```

*See page 126 for more information on using the `DATA:FEED` command.*

### READ?

Change the state of the trigger system from the “idle” state to the “wait-for-trigger” state. Measurements will begin when the specified trigger conditions are satisfied following the receipt of the `READ?` command. Readings are sent immediately to the output buffer.

### TRIGger:SOURce {BUS|IMMEDIATE|EXTERNAL}

Select the source from which the multimeter will accept a trigger. The multimeter will accept a software (bus) trigger, an immediate internal trigger (this is the default source), or a hardware trigger from the rear-panel *Ext Trig* (external trigger) terminal. *[Stored in volatile memory]*

### TRIGger:SOURce?

Query the present trigger source. Returns “BUS”, “IMM”, or “EXT”.



**Triggering Commands**

**TRIGger:DElay** {<seconds>|MINimum|MAXimum}

Insert a trigger delay between the trigger signal and each sample that follows. If you do not specify a trigger delay, the multimeter automatically selects a delay for you. Select from 0 to 3600 seconds. MIN = 0 seconds. MAX = 3600 seconds. *[Stored in volatile memory]*

**TRIGger:DElay?** [MINimum|MAXimum]

Query the trigger delay.

**TRIGger:DElay:AUTO** {OFF|ON}

Disable or enable an automatic trigger delay. The delay is determined by function, range, integration time, and ac filter setting. Selecting a specific trigger delay value automatically turns off the automatic trigger delay. *[Stored in volatile memory]*

**TRIGger:DElay:AUTO?**

Query the automatic trigger delay setting. Returns “0” (OFF) or “1” (ON).

**SAMple:COUNT** {<value>|MINimum|MAXimum}

Set the number of readings (samples) the multimeter takes per trigger. Select from 1 to 50,000 readings per trigger. MIN = 1. MAX = 50,000. *[Stored in volatile memory]*

**SAMple:COUNT?** [MINimum|MAXimum]

Query the sample count.

**TRIGger:COUNT** {<value>|MINimum|MAXimum|INFinite}

Set the number of triggers the multimeter will accept before returning to the “idle” state. Select from 1 to 50,000 triggers. The INFinite parameter instructs the multimeter to continuously accept triggers (you must send a device clear to return to the “idle” state). Trigger count is ignored while in local operation. MIN = 1. MAX = 50,000. *[Stored in volatile memory]*

**TRIGger:COUNT?** [MINimum|MAXimum]

Query the trigger count. If you specify an infinite trigger count, the query command returns “9.90000000E+37”.

## System-Related Commands

See also “System-Related Operations,” starting on page 84 in chapter 3.

### **FEtCh?**

Transfer readings stored in the multimeter’s internal memory by the **INITiate** command to the multimeter’s output buffer where you can read them into your bus controller.

### **READ?**

Change the state of the trigger system from the “idle” state to the “wait-for-trigger” state. Measurements will begin when the specified trigger conditions are satisfied following the receipt of the **READ?** command. Readings are sent immediately to the output buffer.

### **DISPlay {OFF|ON}**

Turn the front-panel display off or on. *[Stored in volatile memory]*

### **DISPlay?**

Query the front-panel display setting. Returns “0” (OFF) or “1” (ON).

### **DISPlay:TEXT <quoted string>**

Display a message on the front panel. The multimeter will display up to 12 characters in a message; any additional characters are truncated. *[Stored in volatile memory]*

### **DISPlay:TEXT?**

Query the message sent to the front panel and return a quoted string.

### **DISPlay:TEXT:CLEar**

Clear the message displayed on the front panel.

## System-Related Commands

### **SYSTem:BEEPer**

Issue a single beep immediately.

### **SYSTem:BEEPer:STATe {OFF|ON}**

Disable or enable the front-panel beeper. *[Stored in non-volatile memory]*

When you disable the beeper, the multimeter *will not* emit a tone when:

- 1) a new minimum or maximum is found in a min-max test.
- 2) a stable reading is captured in reading hold.
- 3) a limit is exceeded in a limit test.
- 4) a forward-biased diode is measured in the diode test function.

### **SYSTem:BEEPer:STATe?**

Query the state of the front-panel beeper. Returns “0” (OFF) or “1” (ON).

### **SYSTem:ERRor?**

Query the multimeter’s error queue. Up to 20 errors can be stored in the queue. Errors are retrieved in first-in-first out (FIFO) order. Each error string may contain up to 80 characters.

### **SYSTem:VERSion?**

Query the multimeter to determine the present SCPI version.

### **DATA:POINTs?**

Query the number of readings stored in the multimeter’s internal memory.

### **\*RST**

Reset the multimeter to its power-on configuration.

### **\*TST?**

Perform a complete self-test of the multimeter. Returns “0” if the self-test is successful, or “1” if it test fails.

### **\*IDN?**

Read the multimeter’s identification string (be sure to dimension a string variable with at least 35 characters).

---

## The SCPI Status Model

All SCPI instruments implement status registers in the same way. The status system records various instrument conditions in three register groups: the Status Byte register, the Standard Event register, and the Questionable Data register. The status byte register records high-level summary information reported in the other register groups. The diagram on the next page illustrates the SCPI status system.

*Chapter 6, "Application Programs," contains an example program showing the use of the status registers. You may find it useful to refer to the program after reading the following section in this chapter.*

### **What is an *Event Register*?**

The standard event and questionable data registers have *event registers*. An event register is a read-only register that reports defined conditions within the multimeter. Bits in the event registers *are* latched. Once an event bit is set, subsequent state changes are ignored. Bits in an event register are automatically cleared by a query of that register (such as \*ESR? or STAT:QUES:EVEN?) or by sending the \*CLS (clear status) command. A reset (\*RST) or device clear will not clear bits in event registers. Querying an event register returns a decimal value which corresponds to the binary-weighted sum of all bits set in the register.

### **What is an *Enable Register*?**

An *enable register* defines which bits in the corresponding event register are logically ORed together to form a single summary bit. Enable registers are both readable and writable. Querying an enable register *will not* clear it. The \*CLS (clear status) command does not clear enable registers but it does clear the bits in the event registers. The STATus:PRESet command *will* clear the questionable data enable register. To enable bits in an enable register, you must write a decimal value which corresponds to the binary-weighted sum of the bits you wish to enable in the register.

**SCPI Status System**

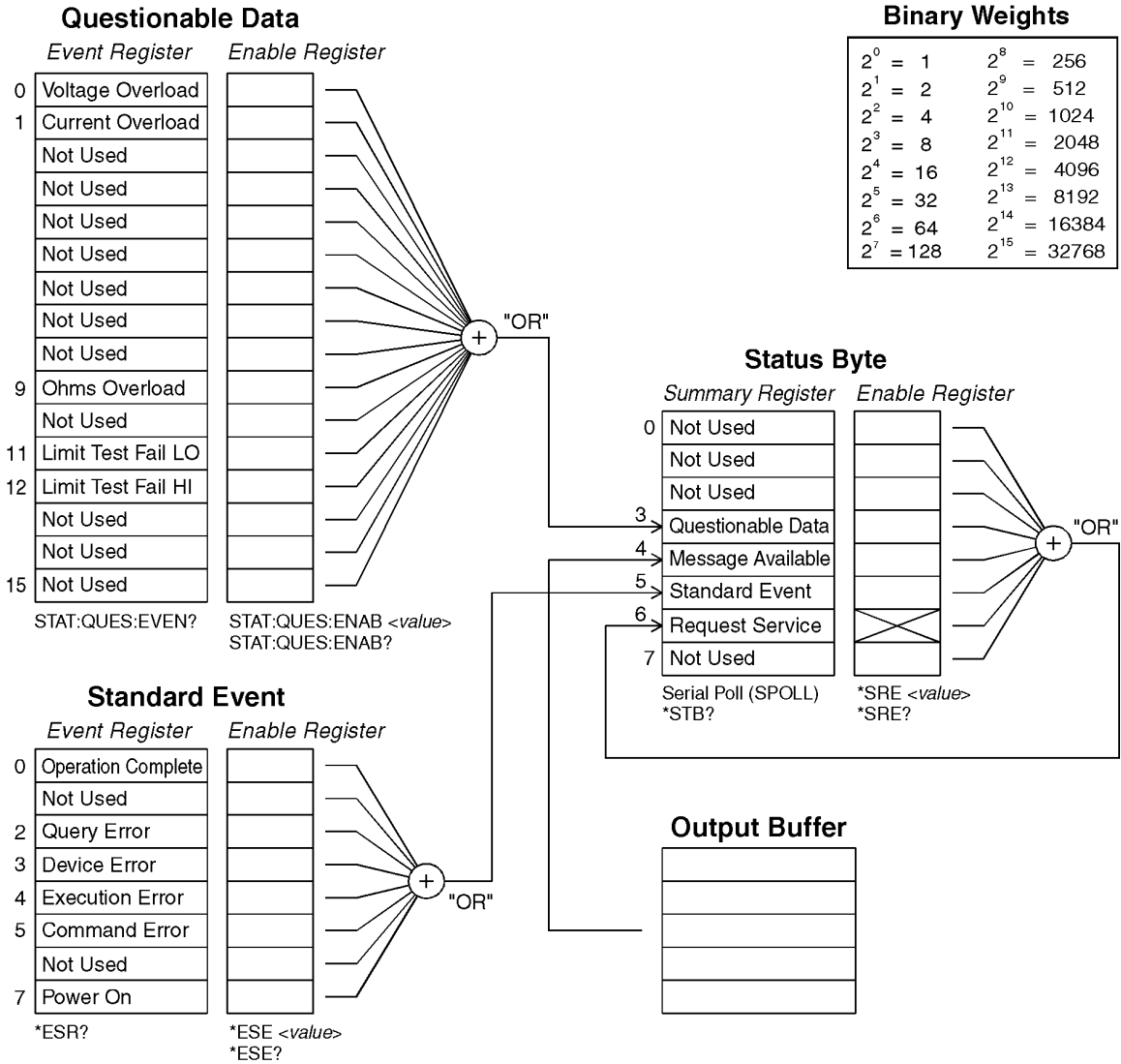

**The SCPI Status Model****The Status Byte**

The status byte *summary register* reports conditions from other status registers. Query data that is waiting in the multimeter's output buffer is immediately reported through the "message available" bit (bit 4). Bits in the summary registers are *not* latched. Clearing an event register will clear the corresponding bits in the status byte summary register. Reading all messages in the output buffer, including any pending queries, will clear the message available bit.

**Bit Definitions – Status Byte Register**

Bit	Decimal Value	Definition
0 Not Used	1	Always set to 0.
1 Not Used	2	Always set to 0.
2 Not Used	4	Always set to 0.
3 Questionable Data	8	One or more bits are set in the Questionable Data register (bits must be "enabled" in enable register).
4 Message Available	16	Data is available in the multimeter's output buffer.
5 Standard Event	32	One or more bits are set in the Standard Event register (bits must be "enabled" in enable register).
6 Request Service	64	The multimeter is requesting service (serial poll).
7 Not Used	128	Always set to 0.

The status byte *summary register* is cleared when:

- You execute a \*CLS (clear status) command.
- Querying the standard event and questionable data registers will clear only the respective bits in the summary register.

The status byte *enable register* (request service) is cleared when:

- You turn on the power and you have previously configured the multimeter using the \*PSC 1 command.
- You execute a \*SRE 0 command.

The status byte enable register *will not* be cleared at power-on if you have previously configured the multimeter using \*PSC 0.

**Using Service Request (SRQ) and Serial POLL**

You must configure your bus controller to respond to the IEEE-488 service request (SRQ) interrupt to use this capability. Use the status byte enable register (SRE) to select which summary bits will set the low-level IEEE-488 SRQ signal. When the status byte “request service” bit (bit 6) is set, an IEEE-488 SRQ interrupt message is automatically sent to the bus controller. The bus controller may then poll the instruments on the bus to identify which one requested service (the one with bit 6 set in its status byte). The request service bit is only cleared by reading the status byte using an IEEE-488 serial poll or by reading the event register whose summary bit is causing the service request.

To read the status byte summary register, send the IEEE-488 serial poll message. Querying the summary register will return a decimal value which corresponds to the binary-weighted sum of the bits set in the register. Serial poll will automatically clear the “request service” bit in the status byte summary register. No other bits are affected. Performing a serial poll will not affect instrument throughput.

---

**Caution**

*The IEEE-488.2 standard does not ensure synchronization between your bus controller program and the instrument. Use the \*OPC? command to guarantee that commands previously sent to the instrument have completed. Executing a serial poll before a \*RST, \*CLS, or other commands have completed can cause previous conditions to be reported.*

---

## The SCPI Status Model

### Using \*STB? to Read the Status Byte

The \*STB? (status byte query) command is similar to a serial poll except it is processed like any other instrument command. The \*STB? command returns the same result as an IEEE-488 serial poll except that the “request service” bit (bit 6) *is not* cleared if a serial poll has occurred. The \*STB? command is not handled automatically by the IEEE-488 bus interface hardware and the command will be executed *only* after previous commands have completed. Polling is not possible using the \*STB? command. Using the \*STB? command does not clear the status byte summary register.

### To Interrupt Your Bus Controller Using SRQ

- Send a bus device clear message.
- Clear the event registers with the \*CLS (clear status) command.
- Set the \*ESE (standard event register) and \*SRE (status byte register) enable masks.
- Send the \*OPC? (operation complete query) command and enter the result to assure synchronization.
- Enable your bus controller’s IEEE-488 SRQ interrupt.

### To Determine When a Command Sequence is Completed

- Send a device clear message to clear the multimeter’s output buffer.
- Clear the event registers with the \*CLS (clear status) command.
- Enable “operation complete” using the \*ESE 1 command (standard event register).
- Send the \*OPC? (operation complete query) command and enter the result to assure synchronization.
- Send your programming command string, and place the \*OPC (operation complete) command as the last command.
- Use a serial poll to check to see when bit 5 (standard event) is set in the status byte summary register. You could also configure the multimeter for an SRQ interrupt by sending \*SRE 32 (status byte enable register, bit 5).



## The SCPI Status Model

### How to Use the Message Available Bit (MAV)

You can use the status byte “message available” bit (bit 4) to determine when data becomes available to read into your bus controller. The multimeter sets bit 4 when the first reading trigger occurs (which can be `TRIGger:SOURce:IMMEDIATE`). The multimeter subsequently clears bit 4 *only* after all messages have been read from the output buffer.

The message available (MAV) bit can only indicate when the *first* reading is available following a `READ?` command. This can be helpful if you do not know when a trigger event such as `BUS` or `EXTERNAL` will occur.

The MAV bit is set only after *all* specified measurements have completed when using the `INITiate` command followed by `FETCh?`. Readings are placed in the multimeter’s internal memory when using `INITiate`. Sending the `FETCh?` command transfers readings (stored in internal memory by the `INITiate` command) to the multimeter’s output buffer. Therefore, the MAV bit can only be set after *all* measurements have been completed.

### Using \*OPC to Signal When Data is in the Output Buffer

Generally, it is best to use the “operation complete” bit (bit 0) in the standard event register to signal when a command sequence is completed. This bit is set in the register after an `*OPC` command has been executed. If you send `*OPC` after a command which loads a message in the multimeter’s output buffer (either reading data or query data), you can use the operation complete bit to determine when the message is available. However, if too many messages are generated before the `*OPC` command executes (sequentially), the output buffer will fill and the multimeter will stop taking readings.

**The SCPI Status Model****The Standard Event Register**

The *standard event* register reports the following types of instrument events: power-on detected, command syntax errors, command execution errors, self-test or calibration errors, query errors, or when an \*OPC command is executed. Any or all of these conditions can be reported in the standard event summary bit through the enable register. You must write a decimal value using the \*ESE (event status enable) command to set the enable register mask.

*An error condition (standard event register bits 2, 3, 4, or 5) will always record one or more errors in the multimeter's error queue, except for the following case. Read the error queue using SYSTem:ERRor?.*

*A reading overload condition is always reported in both the standard event register (bit 3) and the questionable data event register (bits 0, 1, or 9). However, no error message is recorded in the multimeter's error queue.*

**Bit Definitions – Standard Event Register**

Bit	Decimal Value	Definition
0 Operation Complete	1	All commands prior to and including an *OPC command have been executed.
1 Not Used	2	Always set to 0.
2 Query Error	4	The multimeter tried to read the output buffer but it was empty. Or, a new command line was received before a previous query has been read. Or, both the input and output buffers are full.
3 Device Error	8	A self-test, calibration, or reading overload error occurred (see error numbers 501 through 748 in chapter 5).
4 Execution Error	16	An execution error occurred (see error numbers -211 through -230 in chapter 5).
5 Command Error	32	A command syntax error occurred (see error numbers -101 through -158 in chapter 5).
6 Not Used	64	Always set to 0.
7 Power On	128	Power has been turned off and on since the last time the event register was read or cleared.

## The SCPI Status Model

The standard *event register* is cleared when:

- You send a \*CLS (clear status) command.
- You query the event register using the \*ESR? (event status register) command.

The standard event *enable register* is cleared when:

- You turn on the power and you have previously configured the multimeter using the \*PSC 1 command.
- You execute a \*ESE 0 command.

The standard event enable register *will not* be cleared at power-on if you have previously configured the multimeter using \*PSC 0.

**The SCPI Status Model****The Questionable Data Register**

The *questionable data* register provides information about the quality of the multimeter's measurement results. Overload conditions and high/low limit test results are reported. Any or all of these conditions can be reported in the questionable data summary bit through the enable register. You must write a decimal value using the `STATus:QUESTIONable:ENABle` command to set the enable register mask.

**Note:** A reading overload condition is always reported in both the standard event register (bit 3) and the questionable data event register (bits 0, 1, or 9). However, no error message is recorded in the multimeter's error queue.

**Bit Definitions – Questionable Data Register**

Bit	Decimal Value	Definition
0 Voltage Overload	1	Range overload on dc volts, ac volts, frequency, period, diode, or ratio function.
1 Current Overload	2	Range overload on dc or ac current function.
2 Not Used	4	Always set to 0.
3 Not Used	8	Always set to 0.
4 Not Used	16	Always set to 0.
5 Not Used	32	Always set to 0.
6 Not Used	64	Always set to 0.
7 Not Used	128	Always set to 0.
8 Not Used	256	Always set to 0.
9 Ohms Overload	512	Range overload on 2-wire or 4-wire ohms.
10 Not Used	1024	Always set to 0.
11 Limit Fail LO	2048	Reading is less than lower limit in limit test.
12 Limit Fail HI	4096	Reading exceeds upper limit in limit test.
13 Not Used	8192	Always set to 0.
14 Not Used	16384	Always set to 0.
15 Not Used	32768	Always set to 0.

## The SCPI Status Model

The questionable data *event register* is cleared when:

- You execute a \*CLS (clear status) command.
- You query the event register using STATUS:QUESTIONABLE:EVENT?.

The questionable data *enable register* is cleared when:

- You turn on the power (\*PSC does not apply).
- You execute the STATUS:PRESet command.
- You execute the STATUS:QUESTIONABLE:ENABLE 0 command.

## Status Reporting Commands

**SYSTem:ERRor?**

Query the multimeter's error queue. Up to 20 errors can be stored in the queue. Errors are retrieved in first-in-first out (FIFO) order. Each error string may contain up to 80 characters.

**STATus:QUESTionable:ENABle** *<enable value>*

Enable bits in the Questionable Data enable register. The selected bits are then reported to the Status Byte.

**STATus:QUESTionable:ENABle?**

Query the Questionable Data enable register. The multimeter returns a binary-weighted decimal representing the bits set in the enable register.

**STATus:QUESTionable:EVENT?**

Query the Questionable Data event register. The multimeter returns a decimal value which corresponds to the binary-weighted sum of all bits set in the register.

**STATus:PRESet**

Clear all bits in the Questionable Data enable register.

**\*CLS**

Clear the Status Byte summary register and all event registers.

**\*ESE** *<enable value>*

Enable bits in the Standard Event enable register. The selected bits are then reported to the Status Byte.

**\*ESE?**

Query the Standard Event enable register. The multimeter returns a decimal value which corresponds to the binary-weighted sum of all bits set in the register.

## Status Reporting Commands

### **\*ESR?**

Query the Standard event register. The multimeter returns a decimal value which corresponds to the binary-weighted sum of all bits set in the register.

### **\*OPC**

Sets the “operation complete” bit (bit 0) in the Standard Event register after the command is executed.

### **\*OPC?**

Returns “1” to the output buffer after the command is executed.

### **\*PSC {0|1}**

Power-on status clear. Clear the Status Byte and Standard Event register enable masks when power is turned on (\*PSC 1). When \*PSC 0 is in effect, the Status Byte and Standard Event register enable masks *are not* cleared when power is turned on. *[Stored in non-volatile memory]*

### **\*PSC?**

Query the power-on status clear setting. Returns “0” (\*PSC 0) or “1” (\*PSC 1).

### **\*SRE <enable value>**

Enable bits in the Status Byte enable register.

### **\*SRE?**

Query the Status Byte enable register. The multimeter returns a decimal value which corresponds to the binary-weighted sum of all bits set in the register.

### **\*STB?**

Query the Status Byte summary register. The \*STB? command is similar to a serial poll but it is processed like any other instrument command. The \*STB? command returns the same result as a serial poll but the “request service” bit (bit 6) *is not* cleared if a serial poll has occurred.

## Calibration Commands

See “Calibration Overview” starting on page 95 for an overview of the calibration features of the multimeter. For a more detailed discussion of the calibration procedures, see chapter 4 in the Service Guide.

### **CALibration?**

Perform a calibration using the specified calibration value (**CALibration:VALue** command). Before you can calibrate the multimeter, you must unsecure it by entering the correct security code.

### **CALibration:COUNT?**

Query the multimeter to determine the number of times it has been calibrated. Your multimeter was calibrated before it left the factory. When you receive your multimeter, read the count to determine its initial value. *[Stored in non-volatile memory]*

- The calibration count increments up to a maximum of 32,767 after which it wraps-around to 0. Since the value increments by one for each calibration point, a complete calibration will increase the value by many counts.

### **CALibration:SECure:CODE <new code>**

Enter a new security code. To change the security code, you must first unsecure the multimeter using the old security code, and then enter a new code. The calibration code may contain up to 12 characters. *[Stored in non-volatile memory]*

### **CALibration:SECure:STATE {OFF|ON}, <code>**

Unsecure or secure the multimeter for calibration. The calibration code may contain up to 12 characters. *[Stored in non-volatile memory]*

### **CALibration:SECure:STATE?**

Query the secured state of the multimeter. Returns “0” (OFF) or “1” (ON).



## Calibration Commands

**CALibration:STRing** *<quoted string>*

Record calibration information about your multimeter. For example, you can store such information as the last calibration date, the next calibration due date, the instrument serial number, or even the name and phone number of the person to contact for a new calibration.

*[Stored in non-volatile memory]*

- You can record information in the calibration message only from the remote interface. However, you can read the message from either the front-panel menu or the remote interface.
- The calibration message may contain up to 40 characters. However, the multimeter can display only 12 characters of the message on the front panel (additional characters are truncated).

**CALibration:STRing?**

Query the calibration message and return a quoted string.

**CALibration:VALue** *<value>*

Specify the value of the known calibration signal used by the calibration procedure.

**CALibration:VALue?**

Query the present calibration value.

## RS-232 Interface Configuration

*See also "Remote Interface Configuration," on page 91 in chapter 3.*

You connect the multimeter to the RS-232 interface using the 9-pin (DB-9) serial connector on the rear panel. The multimeter is configured as a DTE (*Data Terminal Equipment*) device. For all communications over the RS-232 interface, the multimeter uses two handshake lines: DTR (*Data Terminal Ready*) on pin 4 and DSR (*Data Set Ready*) on pin 6.

The following sections contain information to help you use the multimeter over the RS-232 interface. The programming commands for RS-232 are listed on page 153.

### RS-232 Configuration Overview

Configure the RS-232 interface using the parameters shown below. Use the front-panel I/O MENU to select the baud rate, parity, and number of data bits (*see also pages 163 and 164 for more information*).

- Baud Rate: 300, 600, 1200, 2400, 4800, or **9600 baud** (*factory setting*)
- Parity and Data Bits: None / 8 data bits  
**Even / 7 data bits**, (*factory setting*) or  
*Odd / 7 data bits*
- Number of Start Bits: **1 bit** (*fixed*)
- Number of Stop Bits: **2 bits** (*fixed*)

---

#### Caution

*Do not use the RS-232 interface if you have configured the multimeter to output pass/fail signals on pins 1 and 9. Internal components on the RS-232 interface circuitry may be damaged.*

---

### **RS-232 Data Frame Format**

A character *frame* consists of all the transmitted bits that make up a single character. The frame is defined as the characters from the *start bit* to the last *stop bit*, inclusively. Within the frame, you can select the baud rate, number of data bits, and parity type. The multimeter uses the following frame formats for seven and eight data bits.

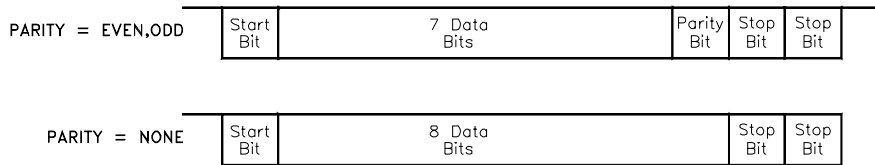

### **Connection to a Computer or Terminal**

To connect the multimeter to a computer or terminal, you must have the proper interface cable. Most computers and terminals are DTE (*Data Terminal Equipment*) devices. Since the multimeter is also a DTE device, you must use a DTE-to-DTE interface cable. These cables are also called *null-modem*, *modem-eliminator*, or *crossover* cables.

The interface cable must also have the proper connector on each end and the internal wiring must be correct. Connectors typically have 9 pins (DB-9 connector) or 25 pins (DB-25 connector) with a “male” or “female” pin configuration. A male connector has pins inside the connector shell and a female connector has holes inside the connector shell.

If you cannot find the correct cable for your configuration, you may have to use a *wiring adapter*. If you are using a DTE-to-DTE cable, make sure the adapter is a “straight-through” type. Typical adapters include gender changers, null-modem adapters, and DB-9 to DB-25 adapters.

Refer to the cable and adapter diagrams on the following page to connect the multimeter to most computers or terminals. If your configuration is different than those described, order the *Agilent 34399A Adapter Kit*. This kit contains adapters for connection to other computers, terminals, and modems. Instructions and pin diagrams are included with the adapter kit.

Chapter 4 Remote Interface Reference  
**RS-232 Interface Configuration**

**DB-9 Serial Connection** If your computer or terminal has a 9-pin serial port with a male connector, use the null-modem cable included with the *Agilent 34398A Cable Kit*. This cable has a 9-pin female connector on each end. The cable pin diagram is shown below.

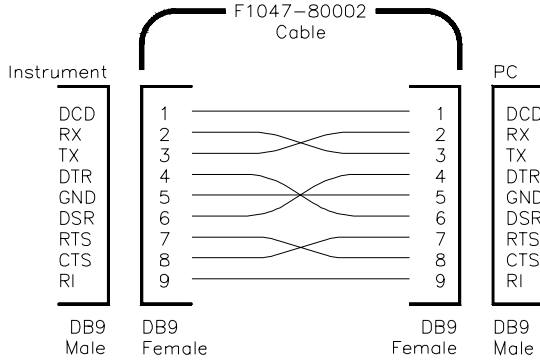

**DB-25 Serial Connection** If your computer or terminal has a 25-pin serial port with a male connector, use the null-modem cable and 25-pin adapter included with the *Agilent 34398A Cable Kit*. The cable and adapter pin diagram is shown below.

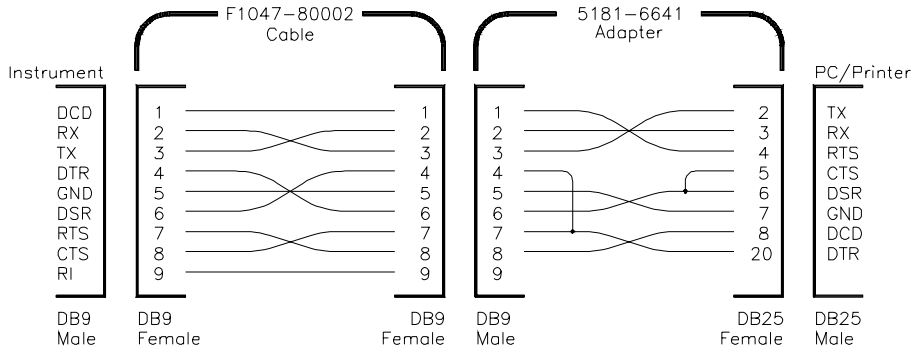

### **DTR / DSR Handshake Protocol**

The multimeter is configured as a DTE (*Data Terminal Equipment*) device and uses the DTR (*Data Terminal Ready*) and DSR (*Data Set Ready*) lines of the RS-232 interface to handshake. The multimeter uses the DTR line to send a hold-off signal. The DTR line must be TRUE before the multimeter will accept data from the interface. When the multimeter sets the DTR line FALSE, the data must cease within 10 characters.

To disable the DTR/DSR handshake, *do not* connect the DTR line and tie the DSR line to logic TRUE. If you disable the DTR/DSR handshake, also select a slower baud rate (300, 600, or 1200 baud) to ensure that the data is transmitted correctly.

*The multimeter sets the DTR line FALSE in the following cases:*

- 1** When the multimeter's input buffer is full (when approximately 100 characters have been received), it sets the DTR line FALSE (pin 4 on the RS-232 connector). When enough characters have been removed to make space in the input buffer, the multimeter sets the DTR line TRUE, unless the second case (*see below*) prevents this.
- 2** When the multimeter wants to "talk" over the interface (which means that it has processed a query) and has received a *<new line>* message terminator, it will set the DTR line FALSE. This implies that once a query has been sent to the multimeter, the controller should read the response before attempting to send more data. It also means that a *<new line>* must terminate the command string. After the response has been output, the multimeter sets the DTR line TRUE again, unless the first case (*see above*) prevents this.

The multimeter monitors the DSR line to determine when the controller is ready to accept data over the interface. The multimeter monitors the DSR line (pin 6 on the RS-232 connector) before each character is sent. The output is suspended if the DSR line is FALSE. When the DSR line goes TRUE, transmission will resume.

## RS-232 Interface Configuration

The multimeter holds the DTR line FALSE while output is suspended. A form of interface *deadlock* exists until the controller asserts the DSR line TRUE to allow the multimeter to complete the transmission. You can break the interface deadlock by sending the `<Ctrl-C>` character, which clears the operation in progress and discards pending output (this is equivalent to the IEEE-488 device clear action). *For the `<Ctrl-C>` character to be recognized reliably by the multimeter while it holds DTR FALSE, the controller must first set DSR FALSE.*

In addition, you may have difficulty sending the `<Ctrl-C>` character if you are interrupting a query operation, in which case the multimeter hold the DTR line FALSE. This may prevent the controller from sending anything unless you first reprogram the interface to ignore DTR.

## RS-232 Troubleshooting

Here are a few things to check if you are having problems communicating over the RS-232 interface. If you need additional help, refer to the documentation that came with your computer.

- Verify that the multimeter and your computer are configured for the same baud rate, parity, and number of data bits. Make sure that your computer is set up for *1 start bit* and *2 stop bits* (these values are fixed on the multimeter).
- Make sure to execute the `SYSTEM:REMOte` command to place the multimeter in the REMOTE mode.
- Verify that you have connected the correct interface cable and adapters. Even if the cable has the proper connectors for your system, the internal wiring may not be correct. The *Agilent 34398A Cable Kit* can be used to connect the multimeter to most computers or terminals.
- Verify that you have connected the interface cable to the correct serial port on your computer (COM1, COM2, etc).

## RS-232 Interface Commands

*Use the front-panel I/O MENU to select the baud rate, parity, and number of data bits (see pages 163 and 164 for more information).*

### **SYSTem:LOCa1**

Place the multimeter in the *local* mode for RS-232 operation. All keys on the front panel are fully functional.

### **SYSTem:REMOte**

Place the multimeter in the *remote* mode for RS-232 operation. All keys on the front panel, except the LOCAL key, are disabled.

*It is very important that you send the **SYSTem:REMOte** command to place the multimeter in the remote mode. Sending or receiving data over the RS-232 interface when not configured for remote operation can cause unpredictable results.*

### **SYSTem:RWLock**

Place the multimeter in the *remote* mode for RS-232 operation. This command is the same as the **SYSTem:REMOte** command except that *all keys* on the front panel are disabled, including the LOCAL key.

### **Ctrl-C**

Clear the operation in progress over the RS-232 interface and discard any pending output data. *This is equivalent to the IEEE-488 device clear action over the GPIB interface.*

## An Introduction to the SCPI Language

SCPI (*Standard Commands for Programmable Instruments*) is an ASCII-based instrument command language designed for test and measurement instruments. Refer to “*Simplified Programming Overview*,” starting on page 112, for an introduction to the basic techniques used to program the multimeter over the remote interface.

SCPI commands are based on a hierarchical structure, also known as a *tree system*. In this system, associated commands are grouped together under a common node or root, thus forming *subsystems*. A portion of the SENSE subsystem is shown below to illustrate the tree system.

```
SENSE:
  VOLTage:
    DC:RANGe {<range>|MINimum|MAXimum}
  VOLTage:
    DC:RANGe? [MINimum|MAXimum]

  FREQuency:
    VOLTage:RANGe {<range>|MINimum|MAXimum}
  FREQuency:
    VOLTage:RANGe? [MINimum|MAXimum]

  DETector:
    BANDwidth {3|20|200|MINimum|MAXimum}
  DETector:
    BANDwidth? [MINimum|MAXimum]

  ZERO:
    AUTO {OFF|ONCE|ON}
  ZERO:
    AUTO?
```

SENSE is the root keyword of the command, VOLTage and FREQuency are second-level keywords, and DC and VOLTage are third-level keywords. A *colon (:)* separates a command keyword from a lower-level keyword.



## Command Format Used in This Manual

The format used to show commands in this manual is shown below:

```
VOLTage:DC:RANGe {<range>|MINimum|MAXimum}
```

The command syntax shows most commands (and some parameters) as a mixture of upper- and lower-case letters. The upper-case letters indicate the abbreviated spelling for the command. For shorter program lines, send the abbreviated form. For better program readability, send the long form.

For example, in the above syntax statement, `VOLT` and `VOLTAGE` are both acceptable forms. You can use upper- or lower-case letters. Therefore, `VOLTAGE`, `volt`, and `VolT` are all acceptable. Other forms, such as `VOL` and `VOLTAG`, will generate an error.

*Braces ( { } )* enclose the parameter choices for a given command string. The braces are not sent with the command string.

A *vertical bar ( | )* separates multiple parameter choices for a given command string.

*Triangle brackets ( < > )* indicate that you must specify a value for the enclosed parameter. For example, the above syntax statement shows the *range* parameter enclosed in triangle brackets. The brackets are not sent with the command string. You must specify a value for the parameter (such as "VOLT:DC:RANG 10").

Some parameters are enclosed in *square brackets ( [ ] )*. The brackets indicate that the parameter is optional and can be omitted. The brackets are not sent with the command string. If you do not specify a value for an optional parameter, the multimeter chooses a default value.

## Command Separators

A *colon* (:) is used to separate a command keyword from a lower-level keyword. You must insert a *blank space* to separate a parameter from a command keyword. If a command requires more than one parameter, you must separate adjacent parameters using a *comma* as shown below:

```
"CONF:VOLT:DC 10, 0.003"
```

A *semicolon* (;) is used to separate commands within the *same* subsystem, and can also minimize typing. For example, sending the following command string:

```
"TRIG:DELAY 1; COUNT 10"
```

... is the same as sending the following two commands:

```
"TRIG:DELAY 1"  
"TRIG:COUNT 10"
```

Use a colon *and* a semicolon to link commands from *different* subsystems. For example, in the following command string, an error is generated if you do not use both the colon *and* semicolon:

```
"SAMP:COUN 10;:TRIG:SOUR EXT"
```

## Using the *MIN* and *MAX* Parameters

You can substitute *MIN*imum or *MAX*imum in place of a parameter for many commands. For example, consider the following command:

```
VOLTage:DC:RANGe {<range>|MINimum|MAXimum}
```

Instead of selecting a specific voltage range, you can substitute *MIN* to set the range to its minimum value or *MAX* to set the range to its maximum value.

## Querying Parameter Settings

You can query the current value of most parameters by adding a *question mark* ( ? ) to the command. For example, the following command sets the sample count to 10 readings:

```
"SAMP:COUN 10"
```

You can query the sample count by executing:

```
"SAMP:COUN?"
```

You can also query the minimum or maximum count allowed as follows:

```
"SAMP:COUN? MIN"  
"SAMP:COUN? MAX"
```

---

### Caution

*If you send two query commands without reading the response from the first, and then attempt to read the second response, you may receive some data from the first response followed by the complete second response. To avoid this, do not send a query command without reading the response. When you cannot avoid this situation, send a device clear before sending the second query command.*

---

## SCPI Command Terminators

A command string sent to the multimeter *must* terminate with a *<new line>* character. The IEEE-488 *EOI* (end-or-identify) message is interpreted as a *<new line>* character and can be used to terminate a command string in place of a *<new line>* character. A *<carriage return>* followed by a *<new line>* is also accepted. Command string termination will *always* reset the current SCPI command path to the root level.

## IEEE-488.2 Common Commands

The IEEE-488.2 standard defines a set of *common commands* that perform functions like reset, self-test, and status operations. Common commands always begin with an asterisk ( \* ), are four to five characters in length, and may include one or more parameters. The command keyword is separated from the first parameter by a *blank space*. Use a *semicolon ( ; )* to separate multiple commands as shown below:

```
"*RST; *CLS; *ESE 32; *OPC?"
```

## SCPI Parameter Types

The SCPI language defines several different data formats to be used in program messages and response messages.

***Numeric Parameters*** Commands that require numeric parameters will accept all commonly used decimal representations of numbers including optional signs, decimal points, and scientific notation. Special values for numeric parameters like MINimum, MAXimum, and DEFault are also accepted. You can also send engineering unit suffixes with numeric parameters (e.g., M, K, or u). If only specific numeric values are accepted, the multimeter will automatically round the input numeric parameters. The following command uses a numeric parameter:

```
VOLTage:DC:RANGe {<range>|MINimum|MAXimum}
```

***Discrete Parameters*** Discrete parameters are used to program settings that have a limited number of values (like BUS, IMMEDIATE, EXTERNAL). They have a short form and a long form just like command keywords. You can mix upper- and lower-case letters. Query responses will *always* return the short form in all upper-case letters. The following command uses discrete parameters:

```
TRIGger:SOURce {BUS|IMMEDIATE|EXTERNAL}
```

**Output Data Formats**

**Boolean Parameters** Boolean parameters represent a single binary condition that is either true or false. For a false condition, the multimeter will accept “OFF” or “0”. For a true condition, the multimeter will accept “ON” or “1”. When you query a boolean setting, the instrument will *always* return “0” or “1”. The following command uses a boolean parameter:

```
INPut:IMPedance:AUTO {OFF|ON}
```

**String Parameters** String parameters can contain virtually any set of ASCII characters. A string *must* begin and end with matching quotes; either with a single quote or with a double quote. You can include the quote delimiter as part of the string by typing it twice without any characters in between. The following command uses a string parameter:

```
DISPlay:TEXT <quoted string>
```

---

## Output Data Formats

Output data will be in one of formats shown in the table below.

Type of Output Data	Output Data Format
Non-reading queries	< 80 ASCII character string
Single reading (IEEE-488)	SD.DDDDDDDDESDD<nl>
Multiple readings (IEEE-488)	SD.DDDDDDDDESDD,.....,<nl>
Single reading (RS-232)	SD.DDDDDDDDESDD<cr><nl>
Multiple readings (RS-232)	SD.DDDDDDDDESDD,.....,<cr><nl>
	<b>S</b> Negative sign or positive sign
	<b>D</b> Numeric digits
	<b>E</b> Exponent
	<b>&lt;nl&gt;</b> newline character
	<b>&lt;cr&gt;</b> carriage return character

## Using Device Clear to Halt Measurements

Device clear is an IEEE-488 low-level bus message which can be used to halt measurements in progress. Different programming languages and IEEE-488 interface cards provide access to this capability through their own unique commands. The status registers, the error queue, and all configuration states are left unchanged when a device clear message is received. Device clear performs the following actions.

- All measurements in progress are aborted.
- The multimeter returns to the trigger “idle state.”
- The multimeter’s input and output buffers are cleared.
- The multimeter is prepared to accept a new command string.

For RS-232 operation, sending the *<Ctrl-C>* character will perform the equivalent operations of the IEEE-488 device clear message. The multimeter’s DTR (data terminal ready) handshake line will be true following a device clear message. See “DTR/DSR Handshake Protocol,” on page 151 for further details.

---

## TALK ONLY for Printers

You can set the address to “31” which is the *talk only* mode. In this mode, the multimeter can output readings directly to a printer without being addressed by a bus controller (over either GPIB or RS-232). For proper operation, make sure your printer is configured in the *listen always* mode. Address 31 is not a valid address if you are operating the multimeter from the GPIB interface with a bus controller.

If you select the RS-232 interface and then set the GPIB address to the talk only address (31), the multimeter will *send* readings over the RS-232 interface when in the local mode.

**To Set the GPIB Address**

---

## To Set the GPIB Address

Each device on the GPIB (IEEE-488) interface must have a unique address. You can set the multimeter's address to any value between 0 and 31. The address is set to "22" when the multimeter is shipped from the factory. The address is displayed on the front panel when you turn on the multimeter. *See also "GPIB Address," on page 91.*

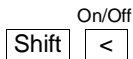
**1 Turn on the front-panel menu.**

A: MEAS MENU

**2 Move across to the I/O MENU choice on this level.**

E: I/O MENU

**3 Move down a level to the HP-IB ADDR command.**

1: HP-IB ADDR

**4 Move down to the "parameter" level to set the address.**

Use the left/right and down/up arrow keys to change the address.

^22 ADDR

**5 Save the change and turn off the menu.**

The address is stored in *non-volatile* memory, and *does not* change when power has been off or after a remote interface reset.

---

## To Select the Remote Interface

The multimeter is shipped with both an GPIB (IEEE-488) interface and an RS-232 interface. Only one interface can be enabled at a time. The GPIB interface is selected when the multimeter is shipped from the factory. *See also "Remote Interface Selection," on page 92.*

On/Off  
Shift <

### 1 Turn on the front-panel menu.

A: MEAS MENU

< <

### 2 Move across to the I/O MENU choice on this level.

E: I/O MENU

∨ >

### 3 Move down a level and then across to the INTERFACE command.

2: INTERFACE

∨

### 4 Move down to the "parameter" level to select the interface.

Use the left/right arrow keys to see the interface choices. Choose from the following: HP-IB / 488 or RS-232.

HP-IB / 488

Auto/Man  
ENTER

### 5 Save the change and turn off the menu.

The interface selection is stored in *non-volatile* memory, and *does not* change when power has been off or after a remote interface reset.



**To Set the Baud Rate**

---

## To Set the Baud Rate

You can select one of six baud rates for RS-232 operation. The rate is set to 9600 baud when the multimeter is shipped from the factory. *See also “Baud Rate Selection,” on page 93.*

Shift <sup>On/Off</sup> <

**1 Turn on the front-panel menu.**

A: MEAS MENU

< <

**2 Move across to the I/O MENU choice on this level.**

E: I/O MENU

∨ > >

**3 Move down a level and then across to the BAUD RATE command.**

3: BAUD RATE

∨

**4 Move down to the “parameter” level to select the baud rate.**

Use the left/right arrow keys to see the baud rate choices. Choose from one of the following: 300, 600, 1200, 2400, 4800, or **9600** baud.

9600 BAUD

Auto/Man  
ENTER

**5 Save the change and exit the menu.**

The baud rate selection is stored in *non-volatile* memory, and *does not* change when power has been off or after a remote interface reset.

## To Set the Parity

You can select the parity for RS-232 operation. The multimeter is configured for even parity with 7 data bits when shipped from the factory. *See also "Parity Selection," on page 93.*

Shift  On/Off

### 1 Turn on the front-panel menu.

A: MEAS MENU

### 2 Move across to the I/O MENU choice on this level.

E: I/O MENU

### 3 Move down a level and then across to the PARITY command.

4: PARITY

### 4 Move down to the “parameter” level to select the parity.

Use the left/right arrow keys to see the parity choices. Choose from one of the following: None (8 data bits), **Even** (7 data bits), or Odd (7 data bits). When you set parity, you are indirectly setting the number of data bits.

EVEN: 7 BITS

Auto/Man  
ENTER

### 5 Save the change and turn off the menu.

The parity selection is stored in *non-volatile* memory, and *does not* change when power has been off or after a remote interface reset.

---

## To Select the Programming Language

You can select one of three languages to program the multimeter from the selected remote interface. The language is SCPI when the multimeter is shipped from the factory. *See also “Programming Language Selection,” on page 94.*

On/Off  
Shift <

### 1 Turn on the front-panel menu.

A: MEAS MENU

< <

### 2 Move across to the I/O MENU choice on this level.

E: I/O MENU

∨ <

### 3 Move down a level and then across to the LANGUAGE command.

5: LANGUAGE

∨

### 4 Move down to the “parameter” level to select the language.

Choose from one of the following: **SCPI**, Agilent 3478A, or Fluke 8840A.

SCPI

Auto/Man  
ENTER

### 5 Save the change and turn off the menu.

The language selection is stored in *non-volatile* memory, and *does not* change when power has been off or after a remote interface reset.

## Alternate Programming Language Compatibility

You can configure the Agilent 34401A to accept and execute the commands of either the Agilent 3478A multimeter or the Fluke 8840A/8842A multimeter. Remote operation will only allow you to access the functionality of the multimeter language selected. You can take advantage of the full functionality of the 34401A only through the SCPI programming language. For more information on selecting the alternate languages from the front panel menu, see “To Select the Programming Language,” on the previous page. From the remote interface, use the following commands to select the alternate languages:

- L1        *select SCPI language*
- L2        *select Agilent 3478A language*
- L3        *select Fluke 8840A language*

Virtually all of the commands available for the other two multimeters are implemented in the 34401A, with the exception of the self-test and calibration commands. You must always calibrate the 34401A using the SCPI language setting. The calibration commands from the other two multimeters will not be executed.

*Be aware that measurement timing may be different in the alternate language compatibility modes.*

### Agilent 3478A Language Setting

All Agilent 3478A commands are accepted and executed by the 34401A with equivalent operations, with the exception of the commands shown below. Refer to your Agilent 3478A *Operating Manual* for further remote interface programming information.

3478A Command	Description	Agilent 34401A Action
C Device Clear	Perform a calibration. Perform a self-test and reset.	Command is accepted but is ignored. Self-test is not executed.

### **Fluke 8840A/8842A Language Setting**

All Fluke 8840A or 8842A commands are accepted and executed by the Agilent 34401A with equivalent operations, with the exception of the commands shown below. Refer to your Fluke 8840A or 8842A *Instruction Manual* for further remote interface programming information.

<b>Fluke 8840A Command</b>	<b>Description</b>	<b>Agilent 34401A Action</b>
G2	GET calibration input prompt.	Generates Error 51 in 8840A/8842A.
G4	GET calibration status.	Returns "1000".
G8	Return identification string.	Returns "HEWLETT-PACKARD, 34401A,0,X-X-X"
P2	PUT variable calibration value.	Generates Error 51 in 8840A/8842A.
P3	PUT user-defined message.	Generates Error 51 in 8840A/8842A.
Z0	Perform self-test.	Self-test is not executed and no errors are recorded in the status byte.
C0	Store input as calibration value.	Generates Error 51 in 8840A/8842A.
C1	Begin A/D calibration.	Generates Error 51 in 8840A/8842A.
C2	Begin high-frequency AC calibration.	Generates Error 51 in 8840A/8842A.
C3	Enter ERASE mode.	Generates Error 51 in 8840A/8842A.



---

## SCPI Compliance Information

The following commands are device-specific to the Agilent 34401A. They are not included in the 1991.0 version of the SCPI standard. However, these commands are designed with the SCPI format in mind and they follow all of the syntax rules of the standard.

*Many of the required SCPI commands are accepted by the multimeter but are not described in this manual for simplicity or clarity. Most of these non-documented commands duplicate the functionality of a command already described in this chapter.*

```
CALCulate
:AVERage:MINimum?
:AVERage:MAXimum?
:AVERage:AVERage?
:AVERage:COUNT?
:DB:REFerence {<value>|MINimum|MAXimum}
:DB:REFerence? [MINimum|MAXimum]
:DBM:REFerence {<value>|MINimum|MAXimum}
:DBM:REFerence? [MINimum|MAXimum]
:FUNCTion {NULL|DB|DBM|AVERage|LIMit}
:FUNCTion?
:LIMit:LOWer {<value>|MINimum|MAXimum}
:LIMit:LOWer? [MINimum|MAXimum]
:LIMit:UPPer {<value>|MINimum|MAXimum}
:LIMit:UPPer? [MINimum|MAXimum]
:NULL:OFFSet {<value>|MINimum|MAXimum}
:NULL:OFFSet? [MINimum|MAXimum]

CALibration
:COUNT?
:SECure:CODE <new code>
:SECure:STATe {OFF|ON}, <code>
:SECure:STATe?
:STRing <quoted string>
:STRing?

CONFIgure
:CONTinuity
:DIODE

INPut
:IMPedance:AUTO {OFF|ON}
:IMPedance:AUTO?

MEASure
:CONTinuity?
:DIODE?

SAMPle
:COUNT {<value>|MINimum|MAXimum}
:COUNT? [MINimum|MAXimum]

[SENSe:]
FUNCTion "CONTinuity"
FUNCTion "DIODE"
FREQuency:VOLTage:RANGE {<range>|MINimum|MAXimum}
FREQuency:VOLTage:RANGE? [MINimum|MAXimum]
FREQuency:VOLTage:RANGE:AUTO {OFF|ON}
FREQuency:VOLTage:RANGE:AUTO?
PERiod:VOLTage:RANGE {<range>|MINimum|MAXimum}
PERiod:VOLTage:RANGE? [MINimum|MAXimum]
PERiod:VOLTage:RANGE:AUTO {OFF|ON}
PERiod:VOLTage:RANGE:AUTO?
ZERO:AUTO?

SYSTEM
:LOCal
:REMote
:RWLock
```

---

## IEEE-488 Compliance Information

### Dedicated Hardware Lines

ATN	Attention
IFC	Interface Clear
REN	Remote Enable
SRQ	Service Request Interrupt

### Addressed Commands

DCL	Device Clear
EOI	End or Identify Message Terminator
GET	Group Execute Trigger
GTL	Go to Local
LLO	Local Lock-Out
SDC	Selected Device Clear
SPD	Serial Poll Disable
SPE	Serial Poll Enable

### IEEE-488.2 Common Commands

\*CLS  
\*ESE <enable value>  
\*ESE?  
\*ESR?  
\*IDN?  
\*OPC  
\*OPC?  
\*PSC {0|1}  
\*PSC?

\*RST  
\*SRE <enable value>  
\*SRE?  
\*STB?  
\*TRG  
\*TST?





---

Error  
Messages

---

# Error Messages

- Errors are retrieved in first-in-first-out (FIFO) order. The first error returned is the first error that was stored. When you have read all errors from the queue, the **ERROR** annunciator turns off. The multimeter beeps once each time an error is generated.
- If more than 20 errors have occurred, the last error stored in the queue (the most recent error) is replaced with -350, "Too many errors". No additional errors are stored until you remove errors from the queue. If no errors have occurred when you read the error queue, the multimeter responds with +0, "No error".
- The error queue is cleared when power has been off or after a \*CLS (clear status) command has been executed. The \*RST (reset) command *does not* clear the error queue.
- *Front-Panel Operation:*

3: ERROR (SYS MENU)

If the **ERROR** annunciator is on, press Shift > (Recall Menu) to read the errors stored in the queue. The errors are listed *horizontally* on the "parameter" level. All errors are cleared when you go to the "parameter" level and then turn off the menu.

```
ERR 1: -113
```

First error in queue \_\_\_\_\_ Error code \_\_\_\_\_

- *Remote Interface Operation:*

SYSTEM:ERROR? *Reads one error from the error queue*

Errors have the following format (*the error string may contain up to 80 characters*):

-113, "Undefined header"

---

## Execution Errors

- 101 Invalid character**  
An invalid character was found in the command string. You may have inserted a character such as #, \$, or % in the command header or within a parameter. Example: `CONF:VOLT#DC`
- 102 Syntax error**  
Invalid syntax was found in the command string. You may have inserted a blank space before or after a colon in the command header, or before a comma. Example: `SAMP:COUN ,1`
- 103 Invalid separator**  
An invalid separator was found in the command string. You may have used a comma instead of a colon, semicolon, or blank space – or you may have used a blank space instead of a comma. Example: `TRIG:COUN,1` or `CONF:FREQ 1000 0.1`
- 104 Data type error**  
The wrong parameter type was found in the command string. You may have specified a number where a string was expected, or vice versa. Example: `DISP:TEXT 5.0`
- 105 GET not allowed**  
A Group Execute Trigger (GET) is not allowed within a command string.
- 108 Parameter not allowed**  
More parameters were received than expected for the command. You may have entered an extra parameter, or you added a parameter to a command that does not accept a parameter. Example: `READ? 10`
- 109 Missing parameter**  
Fewer parameters were received than expected for the command. You omitted one or more parameters that are required for this command. Example: `SAMP:COUN`

**Execution Errors**

- 112**            **Program mnemonic too long**  
A command header was received which contained more than the maximum 12 characters allowed. Example: `CONFIGURATION:VOLT:DC`
- 113**            **Undefined header**  
A command was received that is not valid for this multimeter. You may have misspelled the command or it may not be a valid command. If you are using the short form of the command, remember that it may contain up to four letters. Example: `TRIG:COUN 3`
- 121**            **Invalid character in number**  
An invalid character was found in the number specified for a parameter value. Example: `STAT:QUES:ENAB #B01010102`
- 123**            **Numeric overflow**  
A numeric parameter was found whose exponent was larger than 32,000. Example: `TRIG:COUN 1E34000`
- 124**            **Too many digits**  
A numeric parameter was found whose mantissa contained more than 255 digits, excluding leading zeros.
- 131**            **Invalid suffix**  
A suffix was incorrectly specified for a numeric parameter. You may have misspelled the suffix. Example: `TRIG:DEL 0.5 SECS`
- 138**            **Suffix not allowed**  
A suffix was received following a numeric parameter which does not accept a suffix. Example: `SAMP:COUN 1 SEC` (SEC is not a valid suffix).
- 148**            **Character data not allowed**  
A discrete parameter was received but a character string or a numeric parameter was expected. Check the list of parameters to verify that you have used a valid parameter type. Example: `DISP:TEXT ON`

**Execution Errors**

- 151**                    **Invalid string data**  
An invalid character string was received. Check to see if you have enclosed the character string in single or double quotes and that the string contains valid ASCII characters. Example: `DISP:TEXT 'ON` (the ending quote is missing).
  
- 158**                    **String data not allowed**  
A character string was received but is not allowed for the command. Check the list of parameters to verify that you have used a valid parameter type. Example: `CALC:STAT 'ON'`
  
- 160 to -168**           **Block data errors**  
*The multimeter does not accept block data.*
  
- 170 to -178**           **Expression errors**  
*The multimeter does not accept mathematical expressions.*
  
- 211**                    **Trigger ignored**  
A Group Execute Trigger (`GET`) or `*TRG` was received but the trigger was ignored. Make sure the multimeter is in the “wait-for-trigger” state before issuing a trigger, and make sure the correct trigger source is selected.
  
- 213**                    **Init ignored**  
An `INITiate` command was received but could not be executed because a measurement was already in progress. Send a device clear to halt a measurement in progress and place the multimeter in the “idle” state.
  
- 214**                    **Trigger deadlock**  
A trigger deadlock occurs when the trigger source is `BUS` and a `READ?` command is received.

## Execution Errors

- 221 Settings conflict**  
This error can be generated in one of the following situations:
- You sent a `CONFigure` or `MEASure` command with `autorange` enabled and with a fixed resolution. Example: `CONF:VOLT:DC DEF,0.1`
  - You turned math on (`CALC:STAT ON`) and then changed to a math operation that was not valid with the present measurement function. For example, dB measurements are not allowed with 2-wire ohms. The math state is turned off as a result of this condition.
- 222 Data out of range**  
A numeric parameter value is outside the valid range for the command. Example: `TRIG:COUN -3`
- 223 Too much data**  
A character string was received but could not be executed because the string length was more than 12 characters. This error can be generated by the `CALibration:STRing` and `DISPlay:TEXT` commands.
- 224 Illegal parameter value**  
A discrete parameter was received which was not a valid choice for the command. You may have used an invalid parameter choice. Example: `CALC:FUNC SCALE` (`SCALE` is not a valid choice).
- 230 Data stale**  
A `FETCh?` command was received but internal reading memory was empty. The reading retrieved may be invalid.
- 330 Self-test failed**  
The multimeter's complete self-test failed from the remote interface (`*TST?` command). In addition to this error, more specific self-test errors are also reported. See also "Self-Test Errors," starting on page 179.

**Execution Errors**

- 350            Too many errors**  
The error queue is full because more than 20 errors have occurred. No additional errors are stored until you remove errors from the queue. The error queue is cleared when power has been off, or after a \*CLS (clear status) command has been executed.
- 410            Query INTERRUPTED**  
A command was received which sends data to the output buffer, but the output buffer contained data from a previous command (the previous data is not overwritten). The output buffer is cleared when power has been off, or after a \*RST (reset) command has been executed.
- 420            Query UNTERMINATED**  
The multimeter was addressed to talk (i.e., to send data over the interface) but a command has not been received which sends data to the output buffer. For example, you may have executed a CONFigure command (which does not generate data) and then attempted an ENTER statement to read data from the remote interface.
- 430            Query DEADLOCKED**  
A command was received which generates too much data to fit in the output buffer and the input buffer is also full. Command execution continues but all data is lost.
- 440            Query UNTERMINATED after indefinite response**  
The \*IDN? command must be the last query command within a command string. Example: \*IDN? ; :SYST:VERS?

**Execution Errors**

- 501 Isolator UART framing error**
- 502 Isolator UART overrun error**
- 511 RS-232 framing error**
- 512 RS-232 overrun error**
- 513 RS-232 parity error**
- 514 Command allowed only with RS-232**  
There are three commands which are only allowed with the RS-232 interface: `SYSTem:LOCal`, `SYSTem:REMOte`, and `SYSTem:RWLock`.
- 521 Input buffer overflow**
- 522 Output buffer overflow**
- 531 Insufficient memory**  
There is not enough memory to store the requested number of readings in internal memory using the `INITiate` command. The product of the sample count (`SAMPlE:COUNT`) and the trigger count (`TRIGger:COUNT`) must not exceed 512 readings.
- 532 Cannot achieve requested resolution**  
The multimeter cannot achieve the requested measurement resolution. You may have specified an invalid resolution in the `CONFIgure` or `MEASure` command.
- 540 Cannot use overload as math reference**  
The multimeter cannot store an overload reading ( $9.90000000E+37$ ) as the math reference for null or dB measurements. The math state is turned off as a result of this condition.
- 550 Command not allowed in local**  
The multimeter received a `READ?` or `MEASure?` command while in the local mode. During RS-232 operation, you should always execute the `SYSTem:REMOte` command before sending other commands over the interface.



## Self-Test Errors

The following errors indicate failures that may occur during a self-test. Refer to the *Service Guide* for more information.

601	<b>Front panel does not respond</b>
602	<b>RAM read/write failed</b>
603	<b>A/D sync stuck</b>
604	<b>A/D slope convergence failed</b>
605	<b>Cannot calibrate rundown gain</b>
606	<b>Rundown gain out of range</b>
607	<b>Rundown too noisy</b>
608	<b>Serial configuration readback failed</b>
609	<b>DC gain x1 failed</b>
610	<b>DC gain x10 failed</b>
611	<b>DC gain x100 failed</b>
612	<b>Ohms 500 nA source failed</b>
613	<b>Ohms 5 uA source failed</b>
614	<b>DC 1000V zero failed</b>
615	<b>Ohms 10 uA source failed</b>

**Calibration Errors**

616	<b>DC current sense failed</b>
617	<b>Ohms 100 uA source failed</b>
618	<b>DC high voltage attenuator failed</b>
619	<b>Ohms 1 mA source failed</b>
620	<b>AC rms zero failed</b>
621	<b>AC rms full scale failed</b>
622	<b>Frequency counter failed</b>
623	<b>Cannot calibrate precharge</b>
624	<b>Unable to sense line frequency</b>
625	<b>I/O processor does not respond</b>
626	<b>I/O processor failed self-test</b>

---

**Calibration Errors**

The following errors indicate failures that may occur during a calibration. Refer to the *Service Guide* for more information.

701	<b>Cal security disabled by jumper</b> The calibration security feature has been disabled with a jumper inside the multimeter. When applicable, this error will occur at power-on to warn you that the multimeter is unsecured.
702	<b>Cal secured</b> The multimeter is secured against calibration.

**Calibration Errors**

- 703 Invalid secure code**  
An invalid calibration security code was received when attempting to unsecure or secure the multimeter. You must use the same security code to unsecure the multimeter as was used to secure it, and vice versa. The security code may contain up to 12 alphanumeric characters. The first character *must be* a letter.
- 704 Secure code too long**  
A security code was received which contained more than 12 characters.
- 705 Cal aborted**  
A calibration in progress is aborted when you press any front-panel key, send a device clear, or change the local/remote state of the multimeter.
- 706 Cal value out of range**  
The specified calibration value (CALibration:VALue) is invalid for the present function and range.
- 707 Cal signal measurement out of range**  
The specified calibration value (CALibration:VALue) does not match the signal applied to the multimeter.
- 708 Cal signal frequency out of range**  
The input signal frequency for an ac calibration does not match the required input frequency for calibration.
- 709 No cal for this function or range**  
You cannot perform calibrations for ac current, period, continuity, diode, ratio, or on the 100 M $\Omega$  range.
- 710 Full scale correction out of range**
- 720 Cal DCV offset out of range**
- 721 Cal DCI offset out of range**
- 722 Cal RES offset out of range**
- 723 Cal FRES offset out of range**
- 724 Extended resistance self cal failed**

**Calibration Errors**

725	<b>500V DC correction out of range</b>
730	<b>Precharge DAC convergence failed</b>
731	<b>A/D turnover correction out of range</b>
732	<b>AC flatness DAC convergence failed</b>
733	<b>AC low frequency convergence failed</b>
734	<b>AC low frequency correction out of range</b>
735	<b>AC rms converter noise correction out of range</b>
736	<b>AC rms 100th scale linearity correction out of range</b>
740	<b>Cal checksum failed, secure state</b>
741	<b>Cal checksum failed, string data</b>
742	<b>Cal checksum failed, DCV corrections</b>
743	<b>Cal checksum failed, DCI corrections</b>
744	<b>Cal checksum failed, RES corrections</b>
745	<b>Cal checksum failed, FRES corrections</b>
746	<b>Cal checksum failed, AC corrections</b>
747	<b>Cal checksum failed, GPIB address</b>
748	<b>Cal checksum failed, internal data</b>

---

Application  
Programs

---

# Application Programs

This chapter contains several remote interface application programs to help you develop programs for your measurement application. Chapter 4, "Remote Interface Reference," starting on page 103, lists the syntax for the SCPI (Standard Commands for Programmable Instruments) commands available to program the multimeter.

*The QuickBASIC example programs are written for the Agilent 82335A GPIB Interface Card and command library for IBM® PC compatibles.*

*The GPIB (IEEE-488) address is set to "22" when the multimeter is shipped from the factory. The examples in this chapter assume an GPIB address of 22. When sending a remote interface command, you append this address to the GPIB interface's select code (normally "7"). Therefore, with an address of "22" and a select code of "7", the combination is "722".*

*IBM is a U.S. registered trademark of International Business Machines Corporation.*

---

## Using MEASure? for a Single Measurement

The following example uses the MEASure? command to make a single ac current measurement. This is the easiest way to program the multimeter for measurements. However, MEASure? does not offer much flexibility. The example is shown in BASIC and QuickBASIC.

### GPIB Operation Using BASIC

```
10 REAL Rdg
20 ASSIGN @Dmm TO 722
30 CLEAR 7 ! Clear GPIB and dmm
40 OUTPUT @Dmm; "*RST" ! Reset dmm
50 OUTPUT @Dmm; "*CLS" ! Clear dmm status registers
60 OUTPUT @Dmm; "MEASURE:CURRENT:AC? 1A,0.001MA" ! Set to 1 amp ac range
70 ENTER @Dmm; Rdg
80 PRINT Rdg
90 END
```

### GPIB Operation Using QuickBASIC

```
REM $Include "QBSetup"
DEV%=722
INFO1$="*RST"
LENGTH1%=LEN(INFO1$)
INFO2$="*CLS"
LENGTH2%=LEN(INFO2$)
INFO3$="MEASURE:CURRENT:AC? 1A,0.001MA"
LENGTH3%=LEN(INFO3$)

Call IOCLEAR(DEV%)
Call IOOUTPUTS(DEV%, INFO1$, LENGTH1%)
Call IOOUTPUTS(DEV%, INFO2$, LENGTH2%)
Call IOOUTPUTS(DEV%, INFO3$, LENGTH3%)
Call IOENTER(DEV%,Rdg)
Print Rdg
END
```

## Using CONFigure with a Math Operation

The following example uses CONFigure with the dBm math operation. The CONFigure command gives you a little more programming flexibility than the MEASure? command. This allows you to “incrementally” change the multimeter’s configuration. The example is shown in BASIC and QuickBASIC (*see next page*).

### GPIB Operation Using BASIC

```
10 DIM Rdgs(1:5)
20 ASSIGN @Dmm TO 722
30 CLEAR 7 ! Clear GPIB and dmm
40 OUTPUT @Dmm; "*RST" ! Reset dmm
50 OUTPUT @Dmm; "*CLS" ! Clear dmm status registers
60 OUTPUT @Dmm; "CALC:DBM:REF 50" ! 50 ohm reference resistance
70 OUTPUT @Dmm; "CONF:VOLT:AC 1,0.001" ! Set dmm to 1 amp ac range
80 OUTPUT @Dmm; "DET:BAND 200" ! Select 200 Hz (fast) ac filter
90 OUTPUT @Dmm; "TRIG:COUN 5" ! Dmm will accept 5 triggers
100 OUTPUT @Dmm; "TRIG:SOUR IMM" ! Trigger source is IMMEDIATE
110 OUTPUT @Dmm; "CALC:FUNC DBM" ! Select dBm function
120 OUTPUT @Dmm; "CALC:STAT ON" ! Enable math
130 OUTPUT @Dmm; "READ?" ! Take readings; send to output buffer
140 ENTER @Dmm; Rdgs(*)
150 PRINT USING "K,/"; Rdgs(*)
160 END
```



## Chapter 6 Application Programs Using CONFIGure with a Math Operation

### GPIO Operation Using QuickBASIC

```
REM $Include "QBSetup"
DEV&=722
INFO1$="*RST"
LENGTH1%=LEN(INFO1$)
INFO2$="*CLS"
LENGTH2%=LEN(INFO2$)
INFO3$="CALC:DBM:REF 50"
LENGTH3%=LEN(INFO3$)
INFO4$="CONF:VOLT:AC 1,0.001"
LENGTH4%=LEN(INFO4$)
INFO5$="DET:BAND 200"
LENGTH5%=LEN(INFO5$)
INFO6$="TRIG:COUN 5"
LENGTH6%=LEN(INFO6$)
INFO7$="TRIG:SOUR IMM"
LENGTH7%=LEN(INFO7$)
INFO8$="CALC:FUNC DBM"
LENGTH8%=LEN(INFO8$)
INFO9$="CALC:STAT ON"
LENGTH9%=LEN(INFO9$)
INFO10$="READ?"
LENGTH10%=LEN(INFO10$)
DIM A(1:5)
Actual%=0

Call IOCLEAR(DEV&)
Call IOOUTPUTS(DEV&, INFO1$, LENGTH1%)
Call IOOUTPUTS(DEV&, INFO2$, LENGTH2%)
Call IOOUTPUTS(DEV&, INFO3$, LENGTH3%)
Call IOOUTPUTS(DEV&, INFO4$, LENGTH4%)
Call IOOUTPUTS(DEV&, INFO5$, LENGTH5%)
Call IOOUTPUTS(DEV&, INFO6$, LENGTH6%)
Call IOOUTPUTS(DEV&, INFO7$, LENGTH7%)
Call IOOUTPUTS(DEV&, INFO8$, LENGTH8%)
Call IOOUTPUTS(DEV&, INFO9$, LENGTH9%)
Call IOOUTPUTS(DEV&, INFO10$, LENGTH10%)
Call IOENTER(DEV&, Seg A(1),5,Actual%)
For I=1 to 5
    Print A(I);
Next I
END
```

---

## Using the Status Registers

The following example shows how you can use the multimeter's status registers to determine when a command sequence is completed. For more information, see "The SCPI Status Model," starting on page 134. The example is shown in BASIC and QuickBASIC (*see page 190*).

### GPIB Operation Using BASIC

```
10 REAL Aver,Min_rdg,Max_rdg
20 INTEGER Val,Hpib,Mask,Task
30 ASSIGN @Dmm TO 722
40 CLEAR 7 ! Clear GPIB and dmm
50 OUTPUT @Dmm; "*RST" ! Reset dmm
60 OUTPUT @Dmm; "*CLS" ! Clear dmm status registers
70 OUTPUT @Dmm; "*ESE 1" ! Enable "operation complete" bit to set
! "standard event" bit in status byte
80 OUTPUT @Dmm; "*SRE 32" ! Enable "standard event" bit in status byte
! to pull the IEEE-488 SRQ line
90 OUTPUT @Dmm; "*OPC?" ! Assure synchronization
100 ENTER @Dmm; Val
110 !
120 ! Configure the multimeter to make measurements
130 !
140 OUTPUT @Dmm; "CONF:VOLT:DC 10" ! Set dmm to 10 volt dc range
150 OUTPUT @Dmm; "VOLT:DC:NPLC 10" ! Set the integration time to 10 PLCs
160 OUTPUT @Dmm; "TRIG:COUN 100" ! Dmm will accept 100 triggers
170 OUTPUT @Dmm; "CALC:FUNC AVER;STAT ON" ! Select min-max and enable math
180 OUTPUT @Dmm; "INIT" ! Place dmm in "wait-for-trigger" state
190 OUTPUT @Dmm; "*OPC" ! Set "operation complete" bit in standard event
! registers when measurement is complete
200 !
210 Hpib=7
220 ON INTR Hpib GOSUB Read_data
230 Mask=2 ! Bit 1 is SRQ
240 ENABLE INTR Hpib;Mask ! Enable SRQ to interrupt the program
250 !
260 ! Execute other tasks while waiting for data
270 !
```

*Continued on next page >*

## Chapter 6 Application Programs Using the Status Registers

### GPIB Operation Using BASIC *(continued)*

```
280 Task=1
290 WHILE Task=1
300   DISP "Taking Readings"
310   WAIT .5
320   DISP " "
330   WAIT .5
340 END WHILE
350 DISP "AVE = ";Aver; "      MIN = ";Min_rdg; "      MAX = ";Max_rdg
360 STOP
370 !
380 Read_data:      !
390 OUTPUT @Dmm; "CALC:AVER:AVER?;MIN?;MAX?" ! Read the average, min, and max
400 ENTER @Dmm; Aver, Min_rdg, Max_rdg
410 OUTPUT @Dmm; "*CLS" ! Clear dmm status registers
420 Task=0
430 RETURN
440 END
```

## Chapter 6 Application Programs Using the Status Registers

### GPIB Operation Using QuickBASIC

```
REM $Include "QBSetup"  
ISC&=7  
DEV&=722  
INFO1$=" *RST"  
LENGTH1%=LEN( INFO1$ )  
INFO2$=" *CLS"  
LENGTH2%=LEN( INFO2$ )  
INFO3$=" *ESE 1 "  
LENGTH3%=LEN( INFO3$ )  
INFO4$=" *SRE 32 "  
LENGTH4%=LEN( INFO4$ )  
INFO5$=" *OPC?"  
LENGTH5%=LEN( INFO5$ )  
INFO6$=" CONF:VOLT:DC 10 "  
LENGTH6%=LEN( INFO6$ )  
INFO7$=" VOLT:DC:NPLC 10 "  
LENGTH7%=LEN( INFO7$ )  
INFO8$=" TRIG:COUN 100 "  
LENGTH8%=LEN( INFO8$ )  
INFO9$=" CALC:FUNC AVER;STAT ON "  
LENGTH9%=LEN( INFO9$ )  
INFO10$=" INIT"  
LENGTH10%=LEN( INFO10$ )  
INFO11$=" *OPC"  
LENGTH11%=LEN( INFO11$ )  
INFO12$=" CALC:AVER:AVER?;MIN?;MAX? "  
LENGTH12%=LEN( INFO12$ )  
INFO13$=" *CLS"  
LENGTH13%=LEN( INFO13$ )  
DIM A(1:3)  
Actual%=0  
Reading=0
```

*Continued on next page >*

## Chapter 6 Application Programs Using the Status Registers

### GPIB Operation Using QuickBASIC *(continued)*

```
Call IOCLEAR(DEV&)
Call IOOUTPUTS(DEV&, INFO1$, LENGTH1%)
Call IOOUTPUTS(DEV&, INFO2$, LENGTH2%)
ON PEN GOSUB RESULTS
PEN ON
Call IOPEN(ISC&,0)
Call IOOUTPUTS(DEV&, INFO3$, LENGTH3%)
Call IOOUTPUTS(DEV&, INFO4$, LENGTH4%)
Call IOOUTPUTS(DEV&, INFO5$, LENGTH5%)
Call IOENTER(DEV&,Reading)
Call IOOUTPUTS(DEV&, INFO6$, LENGTH6%)
Call IOOUTPUTS(DEV&, INFO7$, LENGTH7%)
Call IOOUTPUTS(DEV&, INFO8$, LENGTH8%)
Call IOOUTPUTS(DEV&, INFO9$, LENGTH9%)
BACK:GOTO BACK
RESULTS:
Call IOOUTPUTS(DEV&, INFO10$, LENGTH10%)
Call IOOUTPUTS(DEV&, INFO11$, LENGTH11%)
Call IOOUTPUTS(DEV&, INFO12$, LENGTH12%)
Call IOENTERA(DEV&, Seg A(1),3,Actual%)
For I=1 to 3
    Print A(I);
Next I
Call IOOUTPUTS(DEV&, INFO13$, LENGTH13%)
END
```

## RS-232 Operation Using QuickBASIC

The following example shows how to send command instructions and receive command responses over the RS-232 interface using QuickBASIC.

### RS-232 Operation Using QuickBASIC

```
CLS
LOCATE 1, 1
DIM cmd$(100), resp$(1000)
' Set up serial port for 9600 baud, even parity, 7 bits;
' Ignore Request to Send and Carrier Detect; Send line feed,
' enable parity check, reserve 1000 bytes for input buffer
'
OPEN "com1:9600,e,7,2,rs,cd,lf,pe" FOR RANDOM AS #1 LEN = 1000
'
' Put the multimeter into the remote operation mode
PRINT #1, ":SYST:REM"
'
' Query the multimeter's id string
'
PRINT #1, "*IDN?"
LINE INPUT #1, resp$
PRINT "*IDN? returned: ", resp$
'
' Ask what revision of SCPI the multimeter conforms to
PRINT #1, ":SYST:VERS?"
LINE INPUT #1, resp$
PRINT ":SYST:VERS? returned: ", resp$
'
' Send a message to the multimeter's display, and generate a beep
PRINT #1, ":SYST:BEEP;:DISP:TEXT '34401A'"
'
' Configure the multimeter for dc voltage readings,
' 10 V range, 0.1 V resolution, 4 readings
PRINT #1, ":CONF:VOLT:DC 10,0.1;:SAMP:COUN 4"
' Trigger the readings, and fetch the results
PRINT #1, ":READ?"
LINE INPUT #1, resp$
PRINT ":READ? returned: ", resp$
END
```

---

## RS-232 Operation Using Turbo C

The following example shows how to program an AT personal computer for interrupt-driven COM port communications. SCPI commands can be sent to the Agilent 34401A and responses received for commands that query information. The following program is written in Turbo C and can be easily modified for use with Microsoft® Quick C.

### RS-232 Operation Using Turbo C

```
#include <bios.h>
#include <stdio.h>
#include <string.h>
#include <dos.h>
#include <conio.h>

#define EVEN_7 (0x18 | 0x02 | 0x04) /* Even parity, 7 data, 2 stop */
#define ODD_7 (0x08 | 0x02 | 0x04) /* Odd parity, 7 data, 2 stop */
#define NONE_8 (0x00 | 0x03 | 0x04) /* None parity, 8 data, 2 stop */
#define BAUD300 0x40
#define BAUD600 0x60
#define BAUD1200 0x80
#define BAUD2400 0xA0
#define BAUD4800 0xC0
#define BAUD9600 0xE0

/* 8250 UART Registers */
#define COM 0x3F8 /* COM1 base port address */
#define THR COM+0 /* LCR bit 7 = 0 */
#define RDR COM+0 /* LCR bit 7 = 0 */
#define IER COM+1 /* LCR bit 7 = 0 */
#define IIR COM+2 /* The rest are don't care for bit 7 */
#define LCR COM+3
#define MCR COM+4
#define LSR COM+5
#define MSR COM+6
```

*Continued on next page >*

*Microsoft is a U.S. registered trademark of Microsoft Corporation.*

Chapter 6 Application Programs  
RS-232 Operation Using Turbo C

RS-232 Operation Using Turbo C (continued)

```
#define IRQ4_int          0xC          /* IRQ4 interrupt vector number */
#define IRQ4_enab        0xEF         /* IRQ4 interrupt controller enable mask */
#define INT_controller   0x20         /* 8259 Interrupt controller address */
#define End_of_interrupt 0x20         /* Non-specific end of interrupt command */

void interrupt int_char_in(void);
void send_ctlc(void);

#define INT_BUF_size 9000

char int_buf[INT_BUF_size], *int_buf_in = int_buf, *int_buf_out = int_buf;
unsigned int int_buf_count = 0;
unsigned char int_buf_ovfl = 0;

int main(int argc, char *argv[])
{
    void interrupt (*oldvect)();
    char command[80], c;
    int i;

    oldvect = getvect(IRQ4_int);          /* Save old interrupt vector */
    setvect(IRQ4_int,int_char_in);       /* Set up new interrupt handler */
    bioscom(0,BAUD9600 | EVEN_7,0);      /* Initialize settings for COM1 */
    outportb(MCR,0x9);                   /* Enable IRQ buffer, DTR = 1 */
    outportb(IER,0x1);                   /* Enable UART data receive interrupt */

    /* Enable IRQ4 in 8259 interrupt controller register */
    outportb(INT_controller+1,inportb(INT_controller+1) & IRQ4_enab);

    do {
        if(int_buf_ovfl) {
            printf("\nBuffer Overflow!!!\n\n");
            int_buf_in = int_buf_out = int_buf;
            int_buf_count = int_buf_ovfl = 0;
        }
    }
```

*Continued on next page >*



RS-232 Operation Using Turbo C (continued)

```
printf("\nEnter command string:\n");
gets(command); strcat(command, "\n"); /* SCPI requires line feed */

if(command[0] == 0x19) send_ctlc(); /* If ^Y then send ^C */
else if(command[0] != 'q') {
    for(i=0; i<strlen(command); i++) {
        /* Wait for DSR and transmitter hold register empty */
        while(!((inportb(LSR) & inportb(MSR) & 0x20)) );
        outportb(THR,command[i]); /* Send character */
    }
}

if(strpbrk(command,"?")) { /* If query then get response */
    c = 0;
    do {
        while(int_buf_count && !kbhit()) {
            putchar(c = *int_buf_out++); int_buf_count--;
            if(int_buf_out >= int_buf + INT_BUF_size) int_buf_out = int_buf;
        }

        if(kbhit()) {
            if(getch() == 0x19) send_ctlc(); /* if ^Y then send ^C */
            c = 0xa; /* Terminate loop */
        }
    } while(c != 0xa);
} /* End if */

while(command[0] != 'q'); /* 'q' to quit program */

outportb(IER,inportb(IER) & 0xfe); /* Disable UART interrupt */
outportb(MCR,0x1); /* Disable IRQ buffer, DTR = 1 */
/* Disable IRQ4 in 8259 interrupt controller register */
outportb(INT_controller+1,inportb(INT_controller+1) | ~IRQ4_enab);
setvect(IRQ4_int,oldvect); /* Restore old interrupt vector */

return(0);
}
```

*Continued on next page >*

RS-232 Operation Using Turbo C (continued)

```
void interrupt int_char_in(void)
{
    enable(); /* Enable hardware interrupts */
    if(int_buf_count < INT_BUF_size) {
        *int_buf_in++ = inportb(RDR); /* Read byte from UART */
        int_buf_count++;
        if(int_buf_in >= int_buf + INT_BUF_size) int_buf_in = int_buf;
        int_buf_ovfl = 0;
    }
    else {
        inportb(RDR); /* Clear UART interrupt */
        int_buf_ovfl = 1;
    }
    outportb(INT_controller,End_of_interrupt); /* Non-specific EOI */
}

void send_ctlc(void)
{
    outportb(MCR,0x8); /* De-assert DTR */
    delay(10); /* Wait 10 mS for stray characters */
    while(!(inportb(LSR) & 0x20)) ; /* Wait on transmitter register */
    outportb(THR,0x3); /* Send ^C */
    while(!(inportb(LSR) & 0x40)) ; /* Wait for ^C to be sent */
    int_buf_in = int_buf_out = int_buf; /* Clear int_char_in buffer */
    int_buf_count = int_buf_ovfl = 0;
    delay(20); /* 20mS for 34401 to clean up */
    outportb(MCR,0x9); /* Assert DTR */
}
```

---

Measurement  
Tutorial

---

# Measurement Tutorial

The Agilent 34401A is capable of making highly accurate measurements. In order to achieve the greatest accuracy, you must take the necessary steps to eliminate potential measurement errors. This chapter describes common errors found in measurements and gives suggestions to help you avoid these errors.

## Thermal EMF Errors

Thermoelectric voltages are the most common source of error in low-level dc voltage measurements. Thermoelectric voltages are generated when you make circuit connections using dissimilar metals at different temperatures. Each metal-to-metal junction forms a *thermocouple*, which generates a voltage proportional to the junction temperature. You should take the necessary precautions to minimize thermocouple voltages and temperature variations in low-level voltage measurements. The best connections are formed using copper-to-copper crimped connections. The table below shows common thermoelectric voltages for connections between dissimilar metals.

Copper-to-	Approx. $\mu\text{V} / ^\circ\text{C}$
Copper	<0.3
Gold	0.5
Silver	0.5
Brass	3
Beryllium Copper	5
Aluminum	5
Kovar or Alloy 42	40
Silicon	500
Copper-Oxide	1000
Cadmium-Tin Solder	0.2
Tin-Lead Solder	5

*The Agilent 34401A's input terminals are copper alloy.*

**Loading Errors (dc volts)**

**Loading Errors (dc volts)**

Measurement loading errors occur when the resistance of the device-under-test (DUT) is an appreciable percentage of the multimeter's own input resistance. The diagram below shows this error source.

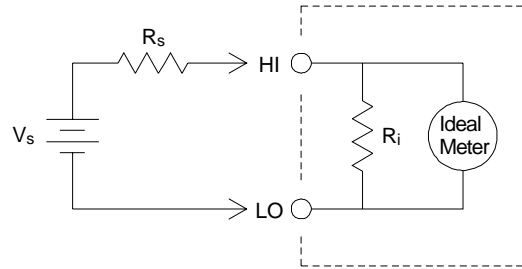

$V_s$  = ideal DUT voltage  
 $R_s$  = DUT source resistance  
 $R_i$  = multimeter input resistance  
 ( 10 M $\Omega$  or >10 G $\Omega$  )

$$\text{Error (\%)} = \frac{100 \times R_s}{R_s + R_i}$$

To reduce the effects of loading errors, and to minimize noise pickup, you can set the multimeter's input resistance to greater than 10 G $\Omega$  for the 100 mVdc, 1 Vdc, and 10 Vdc ranges. The input resistance is maintained at 10 M $\Omega$  for the 100 Vdc and 1000 Vdc ranges.

**Leakage Current Errors**

The multimeter's input capacitance will "charge up" due to input bias currents when the terminals are open-circuited (if the input resistance is 10 G $\Omega$ ). The multimeter's measuring circuitry exhibits approximately 30 pA of input bias current for ambient temperatures from 0 $^{\circ}$ C to 30 $^{\circ}$ C. Bias current will double ( $\times 2$ ) for every 8 $^{\circ}$ C change in ambient temperature above 30 $^{\circ}$ C. This current generates small voltage offsets dependent upon the source resistance of the device-under-test. This effect becomes evident for a source resistance of greater than 100 k $\Omega$ , or when the multimeter's operating temperature is significantly greater than 30 $^{\circ}$ C.

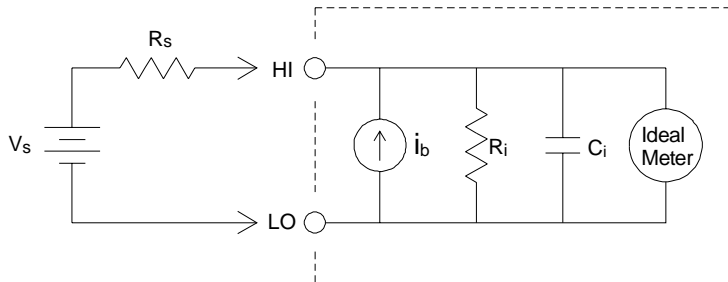

$i_b$  = multimeter bias current  
 $R_s$  = DUT source resistance  
 $C_i$  = multimeter input capacitance  
 For DCV ranges:  
 0.1V, 1V, 10V:  $C_i < 700$  pF  
 100V, 1000V:  $C_i < 50$  pF  
 For all ACV ranges:  $< 50$  pF

$$\text{Error (v)} \cong i_b \times R_s$$

### **Rejecting Power-Line Noise Voltages**

A desirable characteristic of integrating analog-to-digital (A/D) converters is their ability to reject spurious signals. Integrating techniques reject power-line related noise present with dc signals on the input. This is called *normal mode rejection* or *NMR*. Normal mode noise rejection is achieved when the multimeter measures the average of the input by “integrating” it over a fixed period. If you set the integration time to a whole number of power line cycles (PLCs) of the spurious input, these errors (and their harmonics) will average out to approximately zero.

The Agilent 34401A provides three A/D integration times to reject power-line frequency noise (and power-line frequency harmonics). When you apply power to the multimeter, it measures the power-line frequency (50 Hz or 60 Hz), and then determines the proper integration time. The table below shows the noise rejection achieved with various configurations. For better resolution and increased noise rejection, select a longer integration time.

<b>Digits</b>	<b>NPLCs</b>	<b>Integration Time 60 Hz (50 Hz)</b>	<b>NMR</b>
4½ Fast	0.02	400 µs (400 µs)	–
4½ Slow	1	16.7 ms (20 ms)	60 dB
5½ Fast	0.2	3 ms (3 ms)	–
5½ Slow	10	167 ms (200 ms)	60 dB
6½ Fast	10	167 ms (200 ms)	60 dB
6½ Slow	100	1.67 sec (2 sec)	60 dB

### **Common Mode Rejection (CMR)**

Ideally, a multimeter is completely isolated from earth-referenced circuits. However, there is finite resistance between the multimeter's input LO terminal and earth ground as shown below. This can cause errors when measuring low voltages which are floating relative to earth ground.

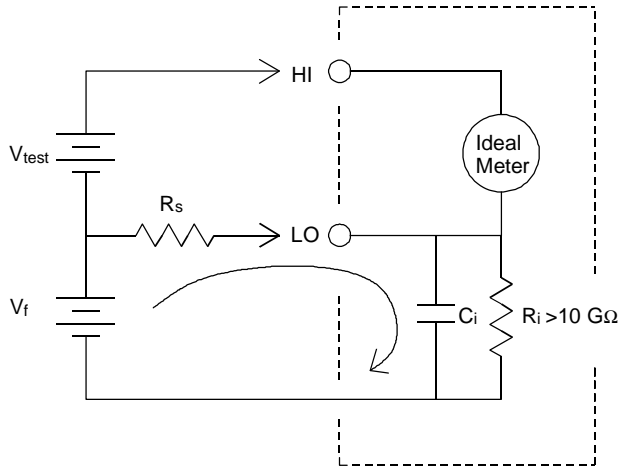

- $V_f$  = float voltage
- $R_s$  = DUT source resistance imbalance
- $R_i$  = multimeter isolation resistance (LO-Earth)
- $C_i$  = multimeter input capacitance:  
≈200 pF (LO-Earth)

$$\text{Error (v)} = \frac{V_f \times R_s}{R_s + R_i}$$

### **Noise Caused by Magnetic Loops**

If you are making measurements near magnetic fields, you should take the necessary precautions to avoid inducing voltages in the measurement connections. You should be especially careful when working near conductors carrying large currents. Use twisted-pair connections to the multimeter to reduce the noise pickup loop area, or dress the test leads as close together as possible. Loose or vibrating test leads will also induce error voltages. Make sure your test leads are tied down securely when operating near magnetic fields. Whenever possible, use magnetic shielding materials or physical separation to reduce problem magnetic field sources.

### Noise Caused by Ground Loops

When measuring voltages in circuits where the multimeter and the device-under-test are both referenced to a common earth ground, a “ground loop” is formed. As shown below, any voltage difference between the two ground reference points ( $V_{\text{ground}}$ ) causes a current to flow through the measurement leads. This causes errors, such as noise and offset voltage (usually power-line related), which are added to the measured voltage.

The best way to eliminate ground loops is to maintain the multimeter’s isolation from earth; do not connect the input terminals to ground. If the multimeter must be earth-referenced, be sure to connect it, and the device-under-test, to the same common ground point. This will reduce or eliminate any voltage difference between the devices. Also make sure the multimeter and device-under-test are connected to the same electrical outlet whenever possible.

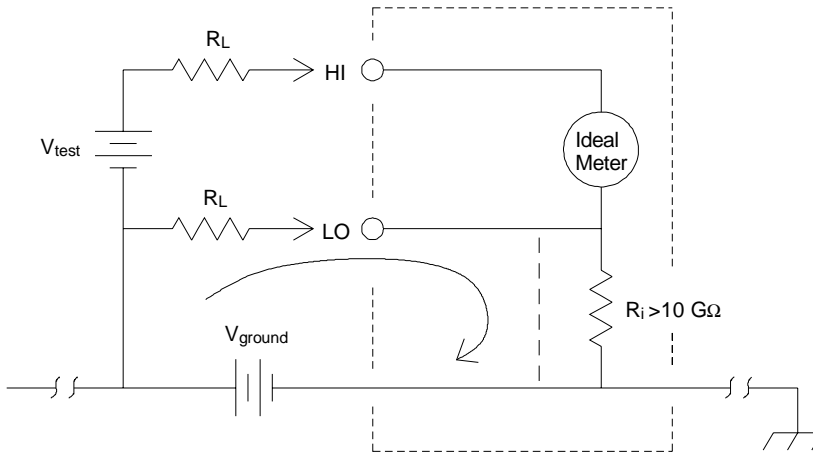

$R_L$  = lead resistance  
 $R_i$  = multimeter isolation resistance  
 $V_{\text{ground}}$  = voltage drop on ground bus



## Resistance Measurements

The Agilent 34401A offers two methods for measuring resistance: *2-wire* and *4-wire* ohms. For both methods, the test current flows from the input HI terminal and then through the resistor being measured. For 2-wire ohms, the voltage drop across the resistor being measured is sensed internal to the multimeter. Therefore, test lead resistance is also measured. For 4-wire ohms, separate “sense” connections are required. Since no current flows in the sense leads, the resistance in these leads does not give a measurement error.

*The errors mentioned earlier in this chapter for dc voltage measurements also apply to resistance measurements. Additional error sources unique to resistance measurements are discussed on the following pages.*

### 4-Wire Ohms Measurements

The 4-wire ohms method provides the most accurate way to measure small resistances. Test lead resistances and contact resistances are automatically reduced using this method. Four-wire ohms is often used in automated test applications where long cable lengths, numerous connections, or switches exist between the multimeter and the device-under-test. The recommended connections for 4-wire ohms measurements are shown below. *See also “To Measure Resistance,” on page 17.*

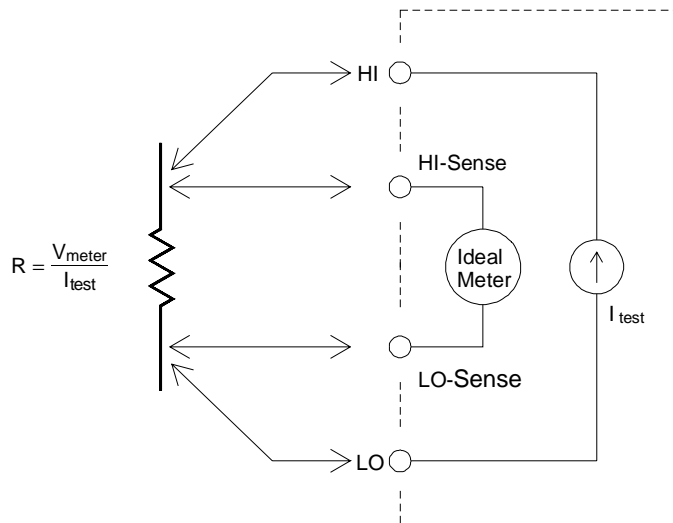

### **Removing Test Lead Resistance Errors**

To eliminate offset errors associated with the test lead resistance in 2-wire ohms measurements, follow the steps below.

1. Short the ends of the test leads together. The multimeter displays the test lead resistance.
2. Press **[Null]** from the front panel. The multimeter displays “0” ohms with the leads shorted together.

### **Power Dissipation Effects**

When measuring resistors designed for temperature measurements (or other resistive devices with large temperature coefficients), be aware that the multimeter will dissipate some power in the device-under-test. If power dissipation is a problem, you should select the multimeter’s next higher measurement range to reduce the errors to acceptable levels. The following table shows several examples.

Range	Test Current	DUT Power at Full Scale
100 $\Omega$	1 mA	100 $\mu$ W
1 k $\Omega$	1 mA	1 mW
10 k $\Omega$	100 $\mu$ A	100 $\mu$ W
100 k $\Omega$	10 $\mu$ A	10 $\mu$ W
1 M $\Omega$	5 $\mu$ A	30 $\mu$ W
10 M $\Omega$	500 nA	3 $\mu$ W

### **Settling Time Effects**

The 34401A has the ability to insert automatic measurement settling delays. These delays are adequate for resistance measurements with less than 200 pF of combined cable and device capacitance. This is particularly important if you are measuring resistances above 100 k $\Omega$ . Settling due to RC time constant effects can be quite long. Some precision resistors and multi-function calibrators use large parallel capacitors (1000 pF to 0.1  $\mu$ F) with high resistor values to filter out noise currents injected by their internal circuitry. Non-ideal capacitances in cables and other devices may have much longer settling times than expected just by RC time constants due to dielectric absorption (soak) effects. Errors will be measured when settling after the initial connection and after a range change.

### **Errors in High Resistance Measurements**

When you are measuring large resistances, significant errors can occur due to insulation resistance and surface cleanliness. You should take the necessary precautions to maintain a “clean” high-resistance system. Test leads and fixtures are susceptible to leakage due to moisture absorption in insulating materials and “dirty” surface films. Nylon and PVC are relatively poor insulators ( $10^9$  ohms) when compared to PTFE Teflon® insulators ( $10^{13}$  ohms). Leakage from nylon or PVC insulators can easily contribute a 0.1% error when measuring a 1 MΩ resistance in humid conditions.

### **DC Current Measurement Errors**

When you connect the multimeter in series with a test circuit to measure current, a measurement error is introduced. The error is caused by the multimeter’s series *burden voltage*. A voltage is developed across the wiring resistance and current shunt resistance of the multimeter as shown below.

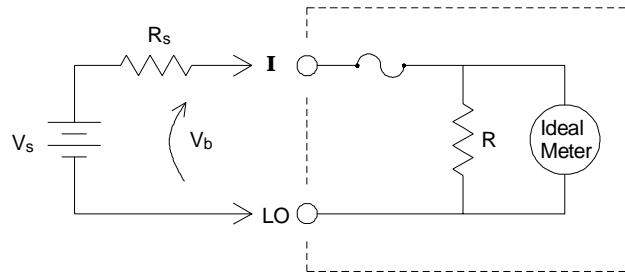



- $V_s$  = source voltage
- $R_s$  = DUT source resistance
- $V_b$  = multimeter burden voltage
- $R$  = multimeter current shunt

$$\text{Error ( \% )} = \frac{-100\% \times V_b}{V_s}$$

*Teflon is a registered trademark of E.I. duPont deNemours and Co.*

**True RMS AC Measurements****True RMS AC Measurements**

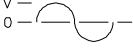
True RMS responding multimeters, like the Agilent 34401A, measure the “heating” potential of an applied voltage. Unlike an “average responding” measurement, a true RMS measurement is used to determine the power dissipated in a resistor. The power is proportional to the square of the measured true RMS voltage, independent of waveshape. An average responding ac multimeter is calibrated to read the same as a true RMS meter for *sinewave inputs only*. For other waveform shapes, an average responding meter will exhibit substantial errors as shown below.

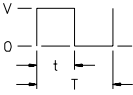
Waveform Shape	Crest Factor (C.F.)	AC RMS	AC+DC RMS	Average Responding Error
	1.414	$\frac{V}{1.414}$	$\frac{V}{1.414}$	Calibrated for 0 error
	1.732	$\frac{V}{1.732}$	$\frac{V}{1.732}$	-3.9%
	$\sqrt{\frac{T}{t}}$	$\frac{V}{C.F.} \times \sqrt{1 - \left(\frac{1}{C.F.}\right)^2}$	$\frac{V}{C.F.}$	-46% for C.F. = 4

The multimeter’s ac voltage and ac current functions measure the ac-coupled true RMS value. This is in contrast to the ac+dc true RMS value shown above. Only the “heating value” of the ac components of the input waveform are measured (dc is rejected). For sinewaves, triangle waves, and square waves, the ac and ac+dc values are equal since these waveforms do not contain a dc offset. Non-symmetrical waveforms, such as pulse trains, contain dc voltages which are rejected by ac-coupled true RMS measurements.

**Crest Factor Errors (non-sinusoidal inputs)**

An ac-coupled true RMS measurement is desirable in situations where you are measuring small ac signals in the presence of large dc offsets. For example, this situation is common when measuring ac ripple present on dc power supplies. There are situations, however, where you might want to know the ac+dc true RMS value. You can determine this value by combining results from dc and ac measurements as shown below. You should perform the dc measurement using at least 10 power line cycles of integration (6 digit mode) for best ac rejection.

$$ac + dc = \sqrt{ac^2 + dc^2}$$

**Crest Factor Errors (non-sinusoidal inputs)**

A common misconception is that “since an ac multimeter is true RMS, its sinewave accuracy specifications apply to all waveforms.” Actually, the shape of the input signal can dramatically affect measurement accuracy. A common way to describe signal waveshapes is *crest factor*. Crest factor is the ratio of the peak value to RMS value of a waveform.

For a pulse train, for example, the crest factor is approximately equal to the square root of the inverse of the duty cycle as shown in the table on the previous page. In general, the greater the crest factor, the greater the energy contained in higher frequency harmonics. All multimeters exhibit measurement errors that are crest factor dependent. Crest factor errors for the Agilent 34401A are shown in the specifications in chapter 8. Note that the crest factor errors do not apply for input signals below 100 Hz when using the slow ac filter.

**Crest Factor**  
*(continued)*

You can estimate the measurement error due to signal crest factor as shown below:

$$Total\ Error = Error\ (sine) + Error\ (crest\ factor) + Error\ (bandwidth)$$

Error (sine): error for sinewave as shown in chapter 8.

Error (crest factor): crest factor additional error as shown in chapter 8.

Error (bandwidth): estimated bandwidth error as shown below.

$$Bandwidth\ Error = \frac{-C.F.^2 \times F}{4 \pi \times BW}$$

C.F. = signal crest factor

F = input fundamental frequency

BW = multimeter's -3 dB bandwidth  
(1 MHz for the Agilent 34401A )

---

**Example**

Calculate the approximate measurement error for a pulse train input with a crest factor of 3 and a fundamental frequency of 20 kHz. For this example, assume the multimeter's *90-day* accuracy specifications:  $\pm (0.05\% + 0.03\%)$ .

$$Total\ Error = 0.08\% + 0.15\% + 1.4\% = 1.6\%$$

**Loading Errors (ac volts)****Loading Errors (ac volts)**

In the ac voltage function, the input of the Agilent 34401A appears as a 1 M $\Omega$  resistance in parallel with 100 pF of capacitance. The cabling that you use to connect signals to the multimeter will also add additional capacitance and loading. The table below shows the multimeter's approximate input resistance at various frequencies.

Input Frequency	Input Resistance
100 Hz	1 M $\Omega$
1 kHz	850 k $\Omega$
10 kHz	160 k $\Omega$
100 kHz	16 k $\Omega$

*For low frequencies:*

$$\text{Error (\%)} = \frac{-100 \times R_s}{R_s + 1 \text{ M}\Omega}$$

*Additional error for high frequencies:*

$$\text{Error (\%)} = 100 \times \left[ \frac{1}{\sqrt{1 + (2\pi \times F \times R_s \times C_{in})^2}} - 1 \right]$$

$R_s$  = source resistance

$F$  = input frequency

$C_{in}$  = input capacitance (100 pF) plus cable capacitance

### **Measurements Below Full Scale**

You can make the most accurate ac measurements when the multimeter is at full scale of the selected range. Autoranging occurs at 10% and 120% of full scale. This enables you to measure some inputs at full scale on one range and 10% of full scale on the next higher range. The accuracy will be significantly different for these two cases. For highest accuracy, you should use manual range to get to the lowest range possible for the measurement.

### **High-Voltage Self-Heating Errors**

If you apply more than 300 Vrms, self-heating will occur in the multimeter's internal signal-conditioning components. These errors are included in the multimeter's specifications. Temperature changes inside the multimeter due to self-heating may cause additional error on other ac voltage ranges. The additional error will be less than 0.02% and will dissipate in a few minutes.

### **Temperature Coefficient and Overload Errors**

The Agilent 34401A uses an ac measurement technique that measures and removes internal offset voltages when you select a different function or range. If you leave the multimeter in the same range for an extended period of time, and the ambient temperature changes significantly (or if the multimeter is not fully warmed up), the internal offsets may change. This temperature coefficient is typically 0.002% of range per °C and is automatically removed when you change functions or ranges.

When manual ranging to a new range in an *overload condition*, the internal offset measurement may be degraded for the selected range. Typically, an additional 0.01% of range error may be introduced. This additional error is automatically removed when you remove the overload condition and then change functions or ranges.



### **Low-Level Measurement Errors**

When measuring ac voltages less than 100 mV, be aware that these measurements are especially susceptible to errors introduced by extraneous noise sources. An exposed test lead will act as an antenna and a properly functioning multimeter will measure the signals received. The entire measurement path, including the power line, act as a loop antenna. Circulating currents in the loop will create error voltages across any impedances in series with the multimeter's input. For this reason, you should apply low-level ac voltages to the multimeter through shielded cables. You should connect the shield to the input LO terminal.

Make sure the multimeter and the ac source are connected to the same electrical outlet whenever possible. You should also minimize the area of any ground loops that cannot be avoided. A high-impedance source is more susceptible to noise pickup than a low-impedance source. You can reduce the high-frequency impedance of a source by placing a capacitor in parallel with the multimeter's input terminals. You may have to experiment to determine the correct capacitor value for your application.

Most extraneous noise is not correlated with the input signal. You can determine the error as shown below.

$$\text{Voltage Measured} = \sqrt{V_{\text{in}}^2 + \text{Noise}^2}$$

Correlated noise, while rare, is especially detrimental. Correlated noise will always add directly to the input signal. Measuring a low-level signal with the same frequency as the local power line is a common situation that is prone to this error.

## Common Mode Errors

### Common Mode Errors

Errors are generated when the multimeter's input LO terminal is driven with an ac voltage relative to earth. The most common situation where unnecessary common mode voltages are created is when the output of an ac calibrator is connected to the multimeter "backwards." Ideally, a multimeter reads the same regardless of how the source is connected. Both source and multimeter effects can degrade this ideal situation.

Because of the capacitance between the input LO terminal and earth (approximately 200 pF for the Agilent 34401A), the source will experience different loading depending on how the input is applied. The magnitude of the error is dependent upon the source's response to this loading. The multimeter's measurement circuitry, while extensively shielded, responds differently in the backward input case due to slight differences in stray capacitance to earth. The multimeter's errors are greatest for high-voltage, high-frequency inputs. Typically, the multimeter will exhibit about 0.06% additional error for a 100 V, 100 kHz reverse input. You can use the grounding techniques described for dc common mode problems to minimize ac common mode voltages (*see page 201*).

### AC Current Measurement Errors

Burden voltage errors, which apply to dc current, also apply to ac current measurements. However, the burden voltage for ac current is larger due to the multimeter's series inductance and your measurement connections. The burden voltage increases as the input frequency increases. Some circuits may oscillate when performing current measurements due to the multimeter's series inductance and your measurement connections.

### **Frequency and Period Measurement Errors**

The multimeter uses a reciprocal counting technique to measure frequency and period. This method generates constant measurement resolution for any input frequency. The multimeter's ac voltage measurement section performs input signal conditioning. All frequency counters are susceptible to errors when measuring low-voltage, low-frequency signals. The effects of both internal noise and external noise pickup are critical when measuring "slow" signals. The error is inversely proportional to frequency. Measurement errors will also occur if you attempt to measure the frequency (or period) of an input following a dc offset voltage change. You must allow the multimeter's input dc blocking capacitor to fully settle before making frequency measurements.

### **Making High-Speed DC and Resistance Measurements**

The multimeter incorporates an automatic zero measurement procedure (autozero) to eliminate internal thermal EMF and bias current errors. Each measurement actually consists of a measurement of the input terminals followed by a measurement of the internal offset voltage. The internal offset voltage error is subtracted from the input for improved accuracy. This compensates for offset voltage changes due to temperature. For maximum reading speed, turn autozero off. This will more than double your reading speeds for dc voltage, resistance, and dc current functions. Autozero does not apply to other measurement functions.

## **Making High-Speed AC Measurements**

The multimeter's ac voltage and ac current functions implement three different low-frequency filters. These filters allow you to trade-off low frequency accuracy for faster reading speed. The *fast filter* settles in 0.1 seconds, and is useful for frequencies above 200 Hz. The *medium filter* settles in 1 second, and is useful for measurements above 20 Hz. The *slow filter* settles in 7 seconds, and is useful for frequencies above 3 Hz.

With a few precautions, you can perform ac measurements at speeds up to 50 readings per second. Use manual ranging to eliminate autoranging delays. By setting the preprogrammed settling (trigger) delays to 0, each filter will allow up to 50 readings per second. However, the measurement might not be very accurate since the filter is not fully settled. In applications where sample-to-sample levels vary widely, the medium filter will settle at 1 reading per second, and the fast filter will settle at 10 readings per second.

If the sample-to-sample levels are similar, little settling time is required for each new reading. Under this specialized condition, the medium filter will provide reduced accuracy results at 5 readings per second, and the fast filter will provide reduced accuracy results at 50 readings per second. Additional settling time may be required when the dc level varies from sample to sample. The multimeter's dc blocking circuitry has a settling time constant of 0.2 seconds. This settling time only affects measurement accuracy when dc offset levels vary from sample to sample. If maximum measurement speed is desired in a scanning system, you may want to add an external dc blocking circuit to those channels with significant dc voltages present. This circuit can be as simple as a resistor and a capacitor.

---

## Specifications

## ■ DC Characteristics

### Accuracy Specifications ± ( % of reading + % of range ) [ 1 ]

Function	Range [ 3 ]	Test Current or Burden Voltage	24 Hour [ 2 ] 23°C ± 1°C	90 Day 23°C ± 5°C	1 Year 23°C ± 5°C	Temperature Coefficient /°C 0°C – 18°C 28°C – 55°C
<b>DC Voltage</b>	100.0000 mV		0.0030 + 0.0030	0.0040 + 0.0035	0.0050 + 0.0035	0.0005 + 0.0005
	1.000000 V		0.0020 + 0.0006	0.0030 + 0.0007	0.0040 + 0.0007	0.0005 + 0.0001
	10.00000 V		0.0015 + 0.0004	0.0020 + 0.0005	0.0035 + 0.0005	0.0005 + 0.0001
	100.0000 V		0.0020 + 0.0006	0.0035 + 0.0006	0.0045 + 0.0006	0.0005 + 0.0001
	1000.000 V		0.0020 + 0.0006	0.0035 + 0.0010	0.0045 + 0.0010	0.0005 + 0.0001
<b>Resistance</b> [ 4 ]	100.0000 Ω	1 mA	0.0030 + 0.0030	0.008 + 0.004	0.010 + 0.004	0.0006 + 0.0005
	1.000000 kΩ	1 mA	0.0020 + 0.0005	0.008 + 0.001	0.010 + 0.001	0.0006 + 0.0001
	10.00000 kΩ	100 μA	0.0020 + 0.0005	0.008 + 0.001	0.010 + 0.001	0.0006 + 0.0001
	100.0000 kΩ	10 μA	0.0020 + 0.0005	0.008 + 0.001	0.010 + 0.001	0.0006 + 0.0001
	1.000000 MΩ	5 μA	0.002 + 0.001	0.008 + 0.001	0.010 + 0.001	0.0010 + 0.0002
	10.00000 MΩ	500 nA	0.015 + 0.001	0.020 + 0.001	0.040 + 0.001	0.0030 + 0.0004
	100.0000 MΩ	500 nA // 10 MΩ	0.300 + 0.010	0.800 + 0.010	0.800 + 0.010	0.1500 + 0.0002
<b>DC Current</b>	10.00000 mA	< 0.1 V	0.005 + 0.010	0.030 + 0.020	0.050 + 0.020	0.002 + 0.0020
	100.0000 mA	< 0.6 V	0.01 + 0.004	0.030 + 0.005	0.050 + 0.005	0.002 + 0.0005
	1.000000 A	< 1 V	0.05 + 0.006	0.080 + 0.010	0.100 + 0.010	0.005 + 0.0010
	3.000000 A	< 2 V	0.10 + 0.020	0.120 + 0.020	0.120 + 0.020	0.005 + 0.0020
<b>Continuity</b>	1000.0 Ω	1 mA	0.002 + 0.030	0.008 + 0.030	0.010 + 0.030	0.001 + 0.002
<b>Diode Test</b> [12]	1.0000 V	1 mA	0.002 + 0.010	0.008 + 0.020	0.010 + 0.020	0.001 + 0.002
<b>DC:DC Ratio</b>	100 mV to 1000 V		( Input Accuracy ) + ( Reference Accuracy )			
			<i>Input Accuracy</i> = accuracy specification for the HI-LO input signal. <i>Reference Accuracy</i> = accuracy specification for the HI-LO reference input signal.			

### Transfer Accuracy ( typical )

$$\frac{(\text{24 hour \% of range error})}{2}$$

#### Conditions:

- Within 10 minutes and ± 0.5°C.
- Within ±10% of initial value.
- Following a 2-hour warm-up.
- Fixed range between 10% and 100% of full scale.
- Using 6½ digit slow resolution ( 100 PLC ).
- Measurements are made using accepted metrology practices.

## Chapter 8 Specifications DC Characteristics

### Measuring Characteristics

#### DC Voltage

Measurement Method:	Continuously integrating, multi-slope III A/D converter.
A/D Linearity:	0.0002% of reading + 0.0001% of range
Input Resistance:	
0.1 V, 1 V, 10 V ranges	Selectable 10 M $\Omega$ or >10 G $\Omega$ [11]
100 V, 1000 V ranges	10 M $\Omega$ $\pm$ 1%
Input Bias Current:	< 30 pA at 25°C
Input Terminals:	Copper alloy
Input Protection:	1000 V on all ranges

#### Resistance

Measurement Method:	Selectable 4-wire or 2-wire ohms. Current source referenced to LO input.
Max. Lead Resistance: (4-wire ohms)	10% of range per lead for 100 $\Omega$ , 1 k $\Omega$ ranges. 1 k $\Omega$ per lead on all other ranges.
Input Protection:	1000 V on all ranges

#### DC Current

Shunt Resistor:	0.1 $\Omega$ for 1A, 3A. 5 $\Omega$ for 10 mA, 100 mA
Input Protection:	Externally accessible 3A, 250 V fuse Internal 7A, 250 V fuse

#### Continuity / Diode Test

Response Time:	300 samples/sec with audible tone
Continuity Threshold:	Adjustable from 1 $\Omega$ to 1000 $\Omega$

#### DC:DC Ratio

Measurement Method:	Input HI-LO / Reference HI-LO
Input HI-LO	100 mV to 1000 V ranges
Reference HI-Input LO	100 mV to 10 V ranges (autoranged)
Input to Reference	Reference LO to Input LO voltage < 2 V Reference HI to Input LO voltage < 12V

#### Measurement Noise Rejection

##### 60 Hz ( 50 Hz ) [ 5 ]

DC CMRR	140 dB
---------	--------

##### Integration Time

100 PLC / 1.67s (2s)	
10 PLC / 167 ms (200 ms)	
1 PLC / 16.7 ms (20 ms)	
0.2 PLC / 3 ms (3 ms)	
0.02 PLC / 400 $\mu$ s (400 $\mu$ s)	

##### Normal Mode Rejection [6]

60 dB [ 7 ]
60 dB [ 7 ]
60 dB [ 7 ]
0 dB
0 dB

[12] Accuracy specifications are for the voltage measured at the input terminals only. 1 mA test current is typical. Variation in the current source will create some variation in the voltage drop across a diode junction.

### Operating Characteristics [ 8 ]

Function	Digits	Readings/s	Additional Noise Error
DCV, DCI, and Resistance	6½	0.6 (0.5)	0% of range
	6½	6 (5)	0% of range
	5½	60 (50)	0.001% of range
	5½	300	0.001% of range [10]
	4½	1000	0.01% of range [10]

#### System Speeds [ 9 ]

Function Change	26/sec
Range Change	50/sec
Autorange Time	<30 ms
ASCII readings to RS-232	55/sec
ASCII readings to GPIB	1000/sec
Max. Internal Trigger Rate	1000/sec
Max. External Trigger Rate to Memory	1000/sec
Max. External Trigger Rate to GPIB	900/sec

#### Autozero OFF Operation

Following instrument warm-up at calibration temperature  $\pm$ 1°C and <10 minutes, add 0.0002% range additional error + 5  $\mu$ V.

#### Settling Considerations

Reading settling times are affected by source impedance, cable dielectric characteristics, and input signal changes.

#### Measurement Considerations

Agilent recommends the use of Teflon® or other high-impedance, low-dielectric absorption wire insulation for these measurements.

- [ 1 ] Specifications are for 1-hour warm-up at 6½ digits.
- [ 2 ] Relative to calibration standards.
- [ 3 ] 20% overrange on all ranges, except 1000 Vdc, 3 A range.
- [ 4 ] Specifications are for 4-wire ohms function, or 2-wire ohms using Math Null. Without Math Null, add 0.2  $\Omega$  additional error in 2-wire ohms function.
- [ 5 ] For 1 k $\Omega$  unbalance in LO lead.
- [ 6 ] For power-line frequency  $\pm$  0.1%.
- [ 7 ] For power-line frequency  $\pm$  1%, subtract 20 dB. For  $\pm$  3%, subtract 30 dB.
- [ 8 ] Readings speeds for 60 Hz and ( 50 Hz ) operation, Autozero Off.
- [ 9 ] Speeds are for 4½ digits, Delay 0, Autozero OFF, and Display OFF. Includes measurement and data transfer over GPIB.
- [ 10 ] Add 20  $\mu$ V for dc volts, 4  $\mu$ A for dc current, or 20 m $\Omega$  for resistance.
- [ 11 ] For these ranges, inputs beyond  $\pm$ 17V are clamped through 100 k $\Omega$  (typical).

*Teflon is a registered trademark of E.I. duPont deNemours and Co.*

## ■ AC Characteristics

### Accuracy Specifications ± (% of reading + % of range) [ 1 ]

Function	Range [ 3 ]	Frequency	24 Hour [ 2 ] 23°C ± 1°C	90 Day 23°C ± 5°C	1 Year 23°C ± 5°C	Temperature Coefficient/°C 0°C – 18°C 28°C – 55°C
True RMS AC Voltage [ 4 ]	100.0000 mV	3 Hz – 5 Hz	1.00 + 0.03	1.00 + 0.04	1.00 + 0.04	0.100 + 0.004
		5 Hz – 10 Hz	0.35 + 0.03	0.35 + 0.04	0.35 + 0.04	0.035 + 0.004
		10 Hz – 20 kHz	0.04 + 0.03	0.05 + 0.04	0.06 + 0.04	0.005 + 0.004
		20 kHz – 50 kHz	0.10 + 0.05	0.11 + 0.05	0.12 + 0.05	0.011 + 0.005
		50 kHz – 100 kHz	0.55 + 0.08	0.60 + 0.08	0.60 + 0.08	0.060 + 0.008
		100 kHz – 300 kHz [6]	4.00 + 0.50	4.00 + 0.50	4.00 + 0.50	0.20 + 0.02
	1.000000 V to 750.000 V	3 Hz – 5 Hz	1.00 + 0.02	1.00 + 0.03	1.00 + 0.03	0.100 + 0.003
		5 Hz – 10 Hz	0.35 + 0.02	0.35 + 0.03	0.35 + 0.03	0.035 + 0.003
		10 Hz – 20 kHz	0.04 + 0.02	0.05 + 0.03	0.06 + 0.03	0.005 + 0.003
		20 kHz – 50 kHz	0.10 + 0.04	0.11 + 0.05	0.12 + 0.05	0.011 + 0.005
50 kHz – 100 kHz [5]		0.55 + 0.08	0.60 + 0.08	0.60 + 0.08	0.060 + 0.008	
100 kHz – 300 kHz [6]		4.00 + 0.50	4.00 + 0.50	4.00 + 0.50	0.20 + 0.02	
True RMS AC Current [ 4 ]	1.000000 A	3 Hz – 5 Hz	1.00 + 0.04	1.00 + 0.04	1.00 + 0.04	0.100 + 0.006
		5 Hz – 10 Hz	0.30 + 0.04	0.30 + 0.04	0.30 + 0.04	0.035 + 0.006
		10 Hz – 5 kHz	0.10 + 0.04	0.10 + 0.04	0.10 + 0.04	0.015 + 0.006
	3.00000 A	3 Hz – 5 Hz	1.10 + 0.06	1.10 + 0.06	1.10 + 0.06	0.100 + 0.006
		5 Hz – 10 Hz	0.35 + 0.06	0.35 + 0.06	0.35 + 0.06	0.035 + 0.006
		10 Hz – 5 kHz	0.15 + 0.06	0.15 + 0.06	0.15 + 0.06	0.015 + 0.006

#### Additional Low Frequency Errors ( % of reading )

Frequency	AC Filter		
	Slow	Medium	Fast
10 Hz – 20 Hz	0	0.74	—
20 Hz – 40 Hz	0	0.22	—
40 Hz – 100 Hz	0	0.06	0.73
100 Hz – 200 Hz	0	0.01	0.22
200 Hz – 1 kHz	0	0	0.18
> 1 kHz	0	0	0

#### Additional Crest Factor Errors ( non-sinewave ) [ 7 ]

Crest Factor	Error ( % of reading )
1 – 2	0.05%
2 – 3	0.15%
3 – 4	0.30%
4 – 5	0.40%

#### Sinewave Transfer Accuracy ( typical )

Frequency	Error ( % of range )
10 Hz – 50 kHz	0.002%
50 kHz – 300 kHz	0.005%

#### Conditions:

- Sinewave input.
- Within 10 minutes and ± 0.5°C.
- Within ±10% of initial voltage and ±1% of initial frequency.
- Following a 2-hour warm-up.
- Fixed range between 10% and 100% of full scale ( and <120 V ).
- Using 6½ digit resolution.
- Measurements are made using accepted metrology practices.



## Chapter 8 Specifications AC Characteristics

### Measuring Characteristics

#### Measurement Noise Rejection [ 8 ]

AC CMRR 70 dB

#### True RMS AC Voltage

Measurement Method: AC-coupled True RMS – measures the ac component of input with up to 400 Vdc of bias on any range. Maximum 5:1 at full scale

Crest Factor:

AC Filter Bandwidth:

Slow 3 Hz – 300 kHz  
Medium 20 Hz – 300 kHz  
Fast 200 Hz – 300 kHz

Input Impedance: 1 M $\Omega$   $\pm$  2%, in parallel with 100 pF

Input Protection: 750 V rms all ranges

#### True RMS AC Current

Measurement Method: Direct coupled to the fuse and shunt. AC-coupled True RMS measurement (measures the ac component only).

Shunt Resistor: 0.1  $\Omega$  for 1 A and 3 A ranges

Burden Voltage: 1 A range: < 1 V rms

3 A range: < 2 V rms

Input Protection: Externally accessible 3A, 250 V fuse  
Internal 7A, 250 V fuse

#### Settling Considerations

Applying >300 V rms (or >1 A rms) will cause self-heating in signal-conditioning components. These errors are included in the instrument specifications. Internal temperature changes due to self-heating may cause additional error on lower ac voltage ranges. The additional error will be less than 0.02% of reading and will generally dissipate within a few minutes.

### Operating Characteristics [ 9 ]

Function	Digits	Reading/s	AC Filter
ACV, ACI	6 $\frac{1}{2}$	7 sec/reading	Slow
	6 $\frac{1}{2}$	1	Medium
	6 $\frac{1}{2}$	1.6 [ 10 ]	Fast
	6 $\frac{1}{2}$	10	Fast
	6 $\frac{1}{2}$	50 [ 11 ]	Fast

#### System Speeds [ 11 ], [ 12 ]

Function or Range Change	5/sec
Autorange Time	<0.8 sec
ASCII readings to RS-232	50/sec
ASCII readings to GPIB	50/sec
Max. Internal Trigger Rate	50/sec
Max. External Trigger Rate to Memory	50/sec
Max. External Trigger Rate to GPIB/RS-232	50/sec

- [ 1 ] Specifications are for 1-hour warm-up at 6 $\frac{1}{2}$  digits, Slow ac filter, sinewave input.
- [ 2 ] Relative to calibration standards.
- [ 3 ] 20% overrange on all ranges, except 750 Vac, 3 A range.
- [ 4 ] Specifications are for sinewave input >5% of range. For inputs from 1% to 5% of range and <50 kHz, add 0.1% of range additional error. For 50 kHz to 100 kHz, add 0.13% of range.
- [ 5 ] 750 Vac range limited to 100 kHz or 8x10<sup>7</sup> Volt-Hz.
- [ 6 ] Typically 30% of reading error at 1 MHz.
- [ 7 ] For frequencies below 100 Hz, slow AC filter specified for sinewave input only.
- [ 8 ] For 1 k $\Omega$  unbalance in LO lead.
- [ 9 ] Maximum reading rates for 0.01% of ac step additional error. Additional settling delay required when input dc level varies.
- [ 10 ] For External Trigger or remote operation using default settling delay ( Delay Auto ).
- [ 11 ] Maximum useful limit with default settling delays defeated.
- [ 12 ] Speeds are for 4 $\frac{1}{2}$  digits, Delay 0, Display OFF, and Fast AC filter.

## ■ Frequency and Period Characteristics

**Accuracy Specifications** ± ( % of reading ) [ 1 ]

Function	Range [ 3 ]	Frequency	Accuracy Specifications ± ( % of reading ) [ 1 ]			
			24 Hour [ 2 ] 23°C ± 1°C	90 Day 23°C ± 5°C	1 Year 23°C ± 5°C	Temperature Coefficient/°C 0°C – 18°C 28°C – 55°C
Frequency, Period [ 4 ]	100 mV to 750 V	3 Hz – 5 Hz	0.10	0.10	0.10	0.005
		5 Hz – 10 Hz	0.05	0.05	0.05	0.005
		10 Hz – 40 Hz	0.03	0.03	0.03	0.001
		40 Hz – 300 kHz	0.006	0.01	0.01	0.001

**Additional Low-Frequency Errors ( % of reading ) [ 4 ]**

Frequency	Resolution		
	6 <sup>1/2</sup>	5 <sup>1/2</sup>	4 <sup>1/2</sup>
3 Hz – 5 Hz	0	0.12	0.12
5 Hz – 10 Hz	0	0.17	0.17
10 Hz – 40 Hz	0	0.2	0.2
40 Hz – 100 Hz	0	0.06	0.21
100 Hz – 300 Hz	0	0.03	0.21
300 Hz – 1 kHz	0	0.01	0.07
> 1 kHz	0	0	0.02

**Transfer Accuracy ( typical )**  
 0.0005% of reading

**Conditions:**

- Within 10 minutes and ± 0.5°C.
- Within ±10% of initial value.
- Following a 2-hour warm-up.
- For inputs > 1 kHz and > 100 mV.
- Using 6<sup>1/2</sup> digit slow resolution ( 1 second gate time ).
- Measurements are made using accepted metrology practices.

## Chapter 8 Specifications Frequency and Period Characteristics

### Measuring Characteristics

#### Frequency and Period

Measurement Method:	Reciprocal-counting technique. AC-coupled input using the ac voltage measurement function.
Voltage Ranges:	100 mV rms full scale to 750 V rms. Auto or manual ranging.
Gate Time:	10 ms, 100 ms, or 1 sec

#### Settling Considerations

Errors will occur when attempting to measure the frequency or period of an input following a dc offset voltage change. The input blocking RC time constant must be allowed to fully settle ( up to 1 sec ) before the most accurate measurements are possible.

#### Measurement Considerations

All frequency counters are susceptible to error when measuring low-voltage, low-frequency signals. Shielding inputs from external noise pickup is critical for minimizing measurement errors.

### Operating Characteristics [ 5 ]

Function	Digits	Reading/s
Frequency,	6½	1
Period	5½ 4½	9.8 80

#### System Speeds [ 5 ]

Configuration Rates	14/sec
Autorange Time	<0.6 sec
ASCII readings to RS-232	55/sec
ASCII readings to GPIB	80/sec
Max. Internal Trigger Rate	80/sec
Max. External Trigger Rate to Memory	80/sec
Max. External Trigger Rate to GPIB/RS-232	80/sec

- [ 1 ] Specifications are for 1-hour warm-up at 6½ digits.
- [ 2 ] Relative to calibration standards.
- [ 3 ] 20% overrange on all ranges, except 750 Vac range.
- [ 4 ] Input > 100 mV.  
For 10 mV to 100 mV inputs, multiply % of reading error x10.
- [ 5 ] Speeds are for 4½ digits, Delay 0, Display OFF, and Fast AC filter.

## ■ General Information

---

### General Specifications

Power Supply:	100 V / 120 V / 220 V / 240 V $\pm$ 10%.
Power Line Frequency:	45 Hz to 66 Hz and 360 Hz to 440 Hz. Automatically sensed at power-on.
Power Consumption:	25 VA peak ( 10 W average )
Operating Environment:	Full accuracy for 0°C to 55°C Full accuracy to 80% R.H. at 40°C -40°C to 70°C
Storage Environment:	-40°C to 70°C
Rack Dimensions (HxWxD):	88.5 mm x 212.6 mm x 348.3 mm
Weight:	3.6 kg (8 lbs)
Safety:	See Declaration of Conformity
EMC:	See Declaration of Conformity
Vibration and Shock:	MIL-T-28800E Type III, Class 5 (data on file)
Warranty:	1 year standard

### Accessories Included

Test Lead Kit with probes, alligator, and grabber attachments.  
User's Guide, Service Guide, test report, and power cord.

---

---

### Triggering and Memory

Reading HOLD Sensitivity:	0.01%, 0.1%, 1%, or 10% of reading
Samples per Trigger:	1 to 50,000
Trigger Delay:	0 to 3600 sec ( 10 $\mu$ s step size )
External Trigger Delay:	< 1 ms
External Trigger Jitter:	< 500 $\mu$ s
Memory:	512 readings

---

### Math Functions

Null, Min/Max/Average, dB, dBm, Limit Test (with TTL output).  
dBm reference resistances: 50, 75, 93, 110, 124, 125, 135, 150,  
250, 300, 500, **600**, 800, 900, 1000, 1200, or 8000 ohms.

---

### Standard Programming Languages

SCPI (*Standard Commands for Programmable Instruments*)  
Agilent 3478A Language Emulation  
Fluke 8840A, Fluke 8842A Language Emulation

---

### Remote Interface

GPIB (IEEE-488.1, IEEE-488.2) and RS-232C

---

*This ISM device complies with Canadian ICES-001.*

*Cet appareil ISM est conforme à la norme NMB-001 du Canada.*





---

## To Calculate Total Measurement Error

Each specification includes correction factors which account for errors present due to operational limitations of the multimeter. This section explains these errors and shows how to apply them to your measurements. Refer to “Interpreting Multimeter Specifications,” starting on page 226, to get a better understanding of the terminology used and to help you interpret the multimeter’s specifications.

The multimeter’s accuracy specifications are expressed in the form: (*% of reading + % of range*). In addition to the reading error and range error, you may need to add additional errors for certain operating conditions. Check the list below to make sure you include *all* measurement errors for a given function. Also, make sure you apply the conditions as described in the footnotes on the specification pages.

- If you are operating the multimeter outside the  $23^{\circ}\text{C} \pm 5^{\circ}\text{C}$  temperature range specified, apply an additional *temperature coefficient error*.
- For dc voltage, dc current, and resistance measurements, you may need to apply an additional *reading speed error* or *autozero OFF error*.
- For ac voltage and ac current measurements, you may need to apply an additional *low frequency error* or *crest factor error*.

**Understanding the “% of reading” Error** The *reading error* compensates for inaccuracies that result from the function and range you select, as well as the input signal level. The reading error varies according to the input level on the selected range. This error is expressed in percent of reading. The following table shows the reading error applied to the multimeter’s 24-hour dc voltage specification.

Range	Input Level	Reading Error (% of reading)	Reading Error Voltage
10 Vdc	10 Vdc	0.0015	$\leq 150 \mu\text{V}$
10 Vdc	1 Vdc	0.0015	$\leq 15 \mu\text{V}$
10 Vdc	0.1 Vdc	0.0015	$\leq 1.5 \mu\text{V}$

Chapter 8 Specifications  
**To Calculate Total Measurement Error**

**Understanding the “% of range” Error** The *range error* compensates for inaccuracies that result from the function and range you select. The range error contributes a constant error, expressed as a percent of range, *independent* of the input signal level. The following table shows the range error applied to the multimeter’s 24-hour dc voltage specification.

Range	Input Level	Range Error (% of range)	Range Error Voltage
10 Vdc	10 Vdc	0.0004	≤ 40 μV
10 Vdc	1 Vdc	0.0004	≤ 40 μV
10 Vdc	0.1 Vdc	0.0004	≤ 40 μV

**Total Measurement Error** To compute the total measurement error, add the reading error and range error. You can then convert the total measurement error to a “percent of input” error or a “ppm (part-per-million) of input” error as shown below.

$$\% \text{ of input error} = \frac{\text{Total Measurement Error}}{\text{Input Signal Level}} \times 100$$

$$\text{ppm of input error} = \frac{\text{Total Measurement Error}}{\text{Input Signal Level}} \times 1,000,000$$

---

**Error Example**

Assume that a 5 Vdc signal is input to the multimeter on the 10 Vdc range. Compute the total measurement error using the 90-day accuracy specifications: ± (0.0020% of reading + 0.0005% of range).

$$\text{Reading Error} = 0.0020\% \times 5 \text{ Vdc} = 100 \mu\text{V}$$

$$\text{Range Error} = 0.0005\% \times 10 \text{ Vdc} = 50 \mu\text{V}$$

$$\begin{aligned} \text{Total Error} &= 100 \mu\text{V} + 50 \mu\text{V} &&= \pm 150 \mu\text{V} \\ & &&= \pm 0.0030\% \text{ of } 5 \text{ Vdc} \\ & &&= \pm 30 \text{ ppm of } 5 \text{ Vdc} \end{aligned}$$

## Interpreting Multimeter Specifications

This section is provided to give you a better understanding of the terminology used and will help you interpret the multimeter's specifications.

### Number of Digits and Overrange

The “number of digits” specification is the most fundamental, and sometimes, the most confusing characteristic of a multimeter. The number of digits is equal to the maximum number of “9’s” the multimeter can measure or display. This indicates the number of *full digits*. Most multimeters have the ability to overrange and add a partial or “½” digit.

For example, the Agilent 34401A can measure 9.9999 Vdc on the 10 V range. This represents six full digits of resolution. The multimeter can also overrange on the 10 V range and measure up to a maximum of 12.00000 Vdc. This corresponds to a 6½-digit measurement with 20% overrange capability.

### Sensitivity

Sensitivity is the minimum level that the multimeter can detect for a given measurement. Sensitivity defines the ability of the multimeter to respond to small changes in the input level. For example, suppose you are monitoring a 1 mVdc signal and you want to adjust the level to within  $\pm 1 \mu\text{V}$ . To be able to respond to an adjustment this small, this measurement would require a multimeter with a sensitivity of at least  $1 \mu\text{V}$ . You could use a 6½-digit multimeter *if* it has a 1 Vdc or smaller range. You could also use a 4½-digit multimeter with a 10 mVdc range.

For ac voltage and ac current measurements, note that the smallest value that can be measured is different from the sensitivity. For the Agilent 34401A, these functions are specified to measure down to 1% of the selected range. For example, the multimeter can measure down to 1 mV on the 100 mV range.



## Resolution

Resolution is the numeric ratio of the maximum displayed value divided by the minimum displayed value on a selected range. Resolution is often expressed in percent, parts-per-million (ppm), counts, or bits. For example, a 6<sup>1/2</sup>-digit multimeter with 20% overrange capability can display a measurement with up to 1,200,000 counts of resolution. This corresponds to about 0.0001% (1 ppm) of full scale, or 21 bits including the sign bit. All four specifications are equivalent.

## Accuracy

Accuracy is a measure of the “exactness” to which the multimeter’s measurement uncertainty can be determined *relative to* the calibration reference used. Absolute accuracy includes the multimeter’s relative accuracy specification plus the known error of the calibration reference relative to national standards (such as the U.S. National Institute of Standards and Technology). To be meaningful, the accuracy specifications must be accompanied with the conditions under which they are valid. These conditions should include temperature, humidity, and time.

There is no standard convention among multimeter manufacturers for the confidence limits at which specifications are set. The table below shows the probability of non-conformance for *each specification* with the given assumptions.

Specification Criteria	Probability of Failure
Mean $\pm$ 2 sigma	4.5%
Mean $\pm$ 3 sigma	0.3%
Mean $\pm$ 4 sigma	0.006%

Variations in performance from reading to reading, and instrument to instrument, decrease for increasing number of sigma for a given specification. This means that you can achieve greater actual measurement precision for a specific accuracy specification number. The Agilent 34401A is designed and tested to meet performance better than mean  $\pm$ 4 sigma of the published accuracy specifications.

### **Transfer Accuracy**

Transfer accuracy refers to the error introduced by the multimeter due to noise and short-term drift. This error becomes apparent when comparing two nearly-equal signals for the purpose of “transferring” the known accuracy of one device to the other.

### **24-Hour Accuracy**

The 24-hour accuracy specification indicates the multimeter’s relative accuracy over its full measurement range for short time intervals and within a stable environment. Short-term accuracy is usually specified for a 24-hour period and for a  $\pm 1^{\circ}\text{C}$  temperature range.

### **90-Day and 1-Year Accuracy**

These long-term accuracy specifications are valid for a  $23^{\circ}\text{C} \pm 5^{\circ}\text{C}$  temperature range. These specifications include the initial calibration errors plus the multimeter’s long-term drift errors.

### **Temperature Coefficients**

Accuracy is usually specified for a  $23^{\circ}\text{C} \pm 5^{\circ}\text{C}$  temperature range. This is a common temperature range for many operating environments. You must add additional temperature coefficient errors to the accuracy specification if you are operating the multimeter outside a  $23^{\circ}\text{C} \pm 5^{\circ}\text{C}$  temperature range (the specification is per  $^{\circ}\text{C}$ ).

## Configuring for Highest Accuracy Measurements

The measurement configurations shown below assume that the multimeter is in its power-on or reset state. It is also assumed that manual ranging is enabled to ensure proper full scale range selection.

### ***DC Voltage, DC Current, and Resistance Measurements:***

- Set the resolution to 6 digits (you can use the 6 digits slow mode for further noise reduction).
- Set the input resistance to greater than 10 G $\Omega$  (for the 100 mV, 1 V, and 10 V ranges) for the best dc voltage accuracy.
- Use 4-wire ohms for the best resistance accuracy.
- Use Math Null to null the test lead resistance for 2-wire ohms, and to remove interconnection offset for dc voltage measurements.

### ***AC Voltage and AC Current Measurements:***

- Set the resolution to 6 digits.
- Select the slow ac filter (3 Hz to 300 kHz).

### ***Frequency and Period Measurements:***

- Set the resolution to 6 digits.



# Index

*If you have questions relating to the operation of the multimeter, call 1-800-452-4844 in the United States, or contact your nearest Agilent Sales Office.*

- "1/2" digit, 21, 54
- 2-wire ohms
  - See *two-wire ohms*
- 34398A Cable Kit, 149
- 34399A Adapter Kit, 149
- 3478A compatibility, 166
- 34812A BenchLink Software, 1
- 4-wire ohms
  - See *four-wire ohms*
- "9.90000000E+37", 61, 131
  
- A**
- a/d convertor, 55, 57
- abort measurement, 76
- ac bandwidth detector, 51, 214
- ac current
  - connections, 18
  - math functions allowed, 63, 124
  - ranges, 18
  - signal filter, 51, 214
- ac settling times, 51
- ac signal filter, 51, 214
- ac voltage
  - connections, 17
  - loading errors, 209
  - math functions allowed, 63, 124
  - ranges, 17
  - signal filter, 51, 214
- accessories included, 13, 222
- accuracy, highest, 229
- adapters (RS-232), 149
- address, GPIB, 91, 161
- addressed commands (IEEE-488), 169
- Agilent Express, 6
- alternate language compatibility
  - Agilent 3478A, 166
  - Fluke 8840A/8842A, 167
- annunciators, 4
- aperture time, 58
- automatic trigger delays, 81
- autoranging
  - front-panel key, 20
  - threshold values, 20, 61
- auto trigger, 42, 73
- autozero
  - definition, 59, 213
  - vs. integration time, 59
  - vs. resolution, 59
  
- average (min-max) measurements
  - beeper control, 88
  - description, 39, 64
  - front-panel, 39
  - functions allowed, 63, 124
  
- B**
- bandwidth detector, 51, 214
- bandwidth error, 208
- baud rate, 93, 148, 151, 163
- beeper
  - continuity threshold, 19
  - diode threshold, 19
  - enable/disable, 88
- BenchLink software (34812A), 1
- BNC connectors
  - Ext Trig, 5, 83
  - VM Comp, 5, 83
- boolean parameters, 159
- bumpers, removing, 23
- burden voltage, 205, 212
- bus triggering, 75, 127
  
- C**
- cables (RS-232), 150
- CALCulate:FUNCTION, 63, 124
- CALCulate:STATE, 63, 124
- CALibration:COUNT?, 98, 146
- CALibration:SECure, 97, 146
- CALibration:STRing, 99, 147
- calibration
  - changing security code, 98
  - commands, 146
  - count, 98
  - errors, 180
  - message, 99
  - secure procedure, 97
  - security code, factory setting, 95
  - unsecure procedure, 96
- carrying handle
  - adjusting, 16
  - removing, 23
- chassis ground, 5
- CLEAR, 76
- comma separator, 37, 89
  
- command
  - compliance (SCPI), 168
  - summary, 105-111
  - syntax conventions, 50, 105, 155
- common commands, 169
- common mode rejection (CMR), 201
- complete self-test, 13, 86
- CONFigure, 113, 119
  - preset state, 110
- Conformity, Declaration, 237
- connections
  - 2-wire ohms, 17
  - 4-wire ohms, 17
  - ac current, 18
  - ac volts, 17
  - continuity, 19
  - dc current, 18
  - dc volts, 17
  - dcv:dcv ratio, 44
  - diode, 19
  - frequency, 18
  - period, 18
- connectors
  - Ext Trig, 5, 83
  - GPIB interface, 5
  - RS-232 interface, 5
  - VM Comp, 5, 83
- continuity
  - connections, 19
  - current source, 19
  - math functions allowed, 63, 124
  - threshold resistance, 52
- crest factor error, 207, 224
- current
  - ac current
    - connections, 18
    - math functions allowed, 63, 124
    - ranges, 18
    - signal filter, 51, 214
  - dc current
    - connections, 18
    - math functions allowed, 63, 124
    - measurement errors, 205
    - ranges, 18
- current input fuses, replacing, 100
- current source
  - continuity, 19
  - diode, 19

- D**
- DATA:FEED, 65, 126, 130
  - DATA:FEED?, 65, 126, 130
  - DATA:POINTS?, 84, 133
  - data logging to printer, 91, 160
  - data types (SCPI), 158
  - data formats, output, 159
  - dB measurements
    - description, 40, 67
    - front-panel, 40
    - functions allowed, 63, 124
    - relative value, 40, 67
  - dBm measurements
    - description, 41, 68
    - front-panel, 41
    - functions allowed, 63, 124
    - resistance values, 41, 68
  - dc current
    - connections, 18
    - math functions allowed, 63, 124
    - measurement errors, 205
    - ranges, 18
  - dc input resistance, 53
  - dc voltage
    - connections, 17
    - input resistance, 53
    - loading errors, 199
    - math functions allowed, 63, 124
    - ranges, 17
  - dcv:dcv ratio measurements
    - connections, 44
    - front panel, 44
    - math functions allowed, 63, 124
    - selecting, 45
  - Declaration of Conformity, 237
  - delay
    - settling, 204
    - trigger, 79
  - DETECTOR:BANDwidth, 51, 123
  - detector bandwidth, 51, 214
  - device clear, 152, 157, 160
  - dielectric absorption, 204
  - digits, number of, 54, 226
  - dimensions, product, 223
  - discrete parameters, 158
  - diode
    - beeper control, 88
    - beeper threshold, 19
    - connections, 19
    - current source, 19
    - math functions allowed, 63, 124
  - display
    - annunciators, 4
    - comma separator, 37, 89
    - enable/disable, 87
    - formats, 22
    - message, 87
  - DISPlay:TEXT, 87, 132
  - DISPlay:TEXT:CLEAr, 87, 132
  - DTR/DSR handshake, 151
- E**
- enable register
    - clearing, 136, 141, 143
    - definition, 134
  - error messages
    - calibration errors, 180
    - error queue, 85, 172
    - error string length, 85, 172
    - execution errors, 173
    - self-test errors, 179
  - errors
    - bandwidth, 208
    - burden voltage, 212
    - common mode, 212
    - crest factor, 207, 224
    - leakage current, 199
    - service request generation, 69, 137
    - temperature coefficient, 224
    - test lead resistance, 204
    - thermal EMF, 198
  - EOI (end-or-identify), 157
  - even parity, 93
  - event register
    - clearing, 141, 143
    - definition, 134
  - examples
    - CONFigure, 116
    - front-panel menu, 31-36
    - MEASure?, 115
  - Ext Trig terminal, 5, 83
  - external trigger, 42, 74, 83
- F**
- fast ac filter, 51, 214
  - FETCh?, 115, 132
  - filler panel kit, 24
  - filter, ac signal, 51, 214
  - firmware revision query, 89
  - fixed range, 61
  - fixed input resistance, 53
  - flange kit, 24
  - flowchart (triggering), 72
  - Fluke 8840A/8842A compatibility, 167
  - format, output data, 159
  - four-wire ohms
    - connections, 17
    - math functions allowed, 63, 124
    - ranges, 17
  - FREQuency:APERture, 58, 122
  - frequency
    - aperture time, 58
    - connections, 18
    - math functions allowed, 63, 124
    - measurement band, 18
  - front panel
    - annunciators, 4
    - beeper, 88
    - comma separator, 37, 89
    - display formats, 22
    - enable/disable, 87
    - menu
      - examples, 31-36
      - messages displayed, 30
      - overview, 3
      - quick reference, 27-28
      - tree diagram, 29
    - messages, front-panel, 87
  - front-panel keys
    - menu, 29
    - range, 20
    - resolution, 21
    - trigger, 42
  - Front/Rear switch, 2, 58
  - fuses
    - current input, 5, 100
    - power-line, 14, 100
  - fuse-holder assembly, 5, 15

**G**

gate time, 58  
 GPIB (IEEE-488)  
 address  
   displayed at power-on, 13  
   factory setting, 91  
   setting the, 91, 161  
   TALK ONLY mode, 91, 160  
 compliance information, 168  
 connector location, 5  
 selecting interface, 92, 162  
 ground, chassis, 5  
 ground loop noise, 202  
 Group Execute Trigger (GET), 75

**H**

"half" digit, 21, 54  
 hardware lines (IEEE-488), 169  
 handle  
   adjusting, 16  
   removing, 23  
 hardware, rack mounting, 24  
 hardware handshake (RS-232), 151  
 HP-IB (See GPIB)

**I**

identification string, 89  
 idle trigger state, 76, 129  
 \*IDN?, 89  
 IEEE-488 (GPIB)  
 address  
   displayed at power-on, 13  
   factory setting, 91  
   setting the, 91, 161  
   TALK ONLY mode, 91, 160  
 compliance information, 168  
 connector location, 5  
 selecting interface, 92, 162  
 induced voltages, 201  
 INITiate, 115, 130  
 input bias current, 199  
 INPut:IMPedance:AUTO, 53, 123  
 input message terminators, 157  
 input resistance, dc volts, 53  
 input signal range  
   frequency, 18  
   period, 18

**input terminals**

  Front/Rear switch, 2, 58  
   query setting, 58  
 input message terminators, 157  
 integration time  
   definition, 57  
   vs. autozero, 59, 60  
   vs. resolution, 54, 57, 59  
 interface (remote)  
   GPIB connector, 5  
   GPIB selection, 92, 162  
   language restrictions, 92, 94  
   RS-232 connector, 5, 150  
   RS-232 selection, 92, 162  
 internal reading memory  
   functions allowed, 46, 84  
   number of readings stored, 84  
   retrieving readings, 46  
   storing readings, 46  
 internal triggering, 75

**L**

L1, L2, L3, 94, 166  
 language  
   command summary, 105-111  
   compatibility, 166  
   compliance (SCPI), 168  
   restrictions, 92, 94  
   selecting, 94, 162  
 lead resistance, 38, 65, 204  
 leakage current errors, 199  
 limit test  
   beeper control, 88  
   description, 69  
   functions allowed, 63, 124  
   RS-232 pass/fail outputs, 70  
   service request, 69, 142  
 line frequency noise, 57  
 line voltage  
   factory setting, 14  
   selector module, 15  
   setting the, 15  
 loading errors  
   ac volts, 209  
   dc volts, 53, 199  
 lock-link kit, 24

**M**

magnetic loops, 201  
 maintenance, 100  
 manual range, 20, 61  
 math operations  
   description, 63, 124  
   functions allowed, 63, 124  
 MEASure?, 113, 117  
   preset state, 112  
 measurement band  
   frequency, 18  
   period, 18  
 measurement errors, 224  
 measurement function  
   math combinations allowed, 63, 124  
 measurement range  
   autoranging, 20, 61  
   front-panel keys, 20  
   overload, 61, 142  
   selecting, 20  
 measurement ranges  
   2-wire ohms, 17  
   4-wire ohms, 17  
   ac current, 18  
   ac volts, 17  
   dc current, 18  
   dc volts, 17  
   dcv:dcv ratio, 44  
   frequency, 18  
   period, 18  
 measurement resolution  
   front-panel keys, 21  
   "half" digit, 21, 54  
   setting, 21  
   power line cycles, 54  
   vs. autozero, 59  
   vs. integration time, 54  
 measurement terminals  
   Front/Rear switch, 2, 58  
   query setting, 58  
 measurement tutorial, 197  
 medium ac filter, 51, 214  
 memory, internal  
   functions allowed, 46, 84  
   number of readings stored, 84  
   retrieving readings, 46  
   storing readings, 46

## menu

- examples, 31-36
- overview, 3
- messages displayed, 30
- quick reference, 27-28
- tree diagram, 29
- messages displayed
  - front-panel, 87
  - menu, 30
- message terminators, 157
- min-max measurements
  - beeper control, 88
  - description, 39, 63
  - front-panel, 39
  - functions allowed, 63, 124

**N**

## noise

- ground loop, 202
- magnetic loops, 201
- power-line voltage, 200
- noise pickup, 53, 199
- noise rejection, 21, 57, 200
- no parity, 93
- normal mode rejection (NMR), 57, 200
- NPLC, 54, 57, 200
- null measurements
  - description, 38, 65
  - front panel, 38
  - functions allowed, 63, 124
  - Null Register, 38, 66
  - null test lead resistance, 38, 65, 204
- number of digits, 54, 226
- number of readings, 77
- numeric parameters, 158

**O**

- odd parity, 93
- offset (null) measurements
  - description, 38, 65
  - front panel, 38
  - functions allowed, 63, 124
  - Null Register, 38, 66
  - null test lead resistance, 38, 65, 204
- offset voltages, 59, 196
- ohms
  - 2-wire
    - connections, 17
    - math functions allowed, 63, 124
    - ranges, 17
  - 4-wire
    - connections, 17
    - math functions allowed, 63, 124
    - ranges, 17
- \*OPC, 137
- operator maintenance, 100
- output data format, 159
- output buffer, 139
- overload, 61, 142
- "OVLd", 61, 142

**P**

- parameter types, 158
- parity, 93, 164
- parts-per-million, 227
- pass/fail limit test
  - beeper control, 88
  - description, 69
  - functions allowed, 63, 124
  - RS-232 pass/fail outputs, 70
  - service request, 69, 142
- PERiod:APERTure, 58, 122
- period
  - aperture time, 58
  - connections, 18
  - math functions allowed, 63, 124
  - measurement band, 18
- power cord, 15
- power dissipation effects, 204
- power line cycles, 54, 57, 200
- power-line frequency
  - power-on sensing, 200

## power-line fuse

- factory configuration, 14
- installation, 15
- power-line noise, rejecting, 200
- power-line voltage
  - factory setting, 14
  - selector module, 15
  - setting the, 15
- power-on
  - self-test, 13
  - sequence, 13
  - state, 101
- product dimensions, 223
- product specifications, 215
- programming language
  - command summary, 105-111
  - compatibility, 166
  - compliance (SCPI), 168
  - restrictions, 92, 94
  - selecting, 94, 165
- pushbuttons (front panel), 2

**Q**

- questionable data register
  - bit definitions, 142
  - clearing, 143

**R**

- rack mounting
  - bumpers, removing, 23
  - carrying handle, removing, 23
  - filler panel kit, 24
  - flange kit, 24
  - lock-link kit, 24
  - sliding-shelf kit, 24
- ranges
  - 2-wire ohms, 17
  - 4-wire ohms, 17
  - ac current, 18
  - ac volts, 17
  - dc current, 18
  - dc volts, 17
  - dCV:dCV ratio, 44
  - frequency, 18
  - period, 18



- 
- ranging
    - autoranging, 20, 61
    - front-panel keys, 20
    - overload, 61, 142
    - selecting, 20
  - ratio (dcv:dcv) measurements
    - connections, 44
    - front panel, 44
    - math functions allowed, 63, 124
    - selecting, 45
  - READ?, 114, 130
  - reading hold
    - beeper control, 88
    - description, 43, 82
    - front-panel, 43
    - sensitivity band, 43, 82
  - reading memory
    - functions allowed, 46, 84
    - number of readings stored, 84
    - retrieving readings, 46
    - storing readings, 46
  - readings, number of, 77
  - rear panel
    - input terminals, 5
    - pictorial overview, 5
  - rear terminals
    - query setting, 58, 123
    - selecting, 58
  - reciprocal counting technique, 213
  - register diagram (status), 135
  - regulatory requirements, 237
  - relative value (dB), 40, 67
  - relative measurements
    - description, 38, 65
    - front panel, 38
    - functions allowed, 63, 124
    - Null Register, 38, 66
    - null test lead resistance, 38, 65, 204
  - remote interface
    - GPIB connector, 5
    - GPIB selection, 92, 162
    - language restrictions, 92, 94
    - RS-232 connector, 5, 150
    - RS-232 selection, 92, 162
  - replacing fuses, 100
  - reset state, 101
  - resistance
    - 2-wire
      - connections, 17
      - math functions allowed, 63, 124
      - ranges, 17
    - 4-wire
      - connections, 17
      - math functions allowed, 63, 124
      - ranges, 17
  - resistance, input, 53
  - resolution
    - front-panel keys, 21
    - "half" digit, 21, 54
    - power line cycles, 54
    - setting, 21
    - vs. autozero, 59
    - vs. integration time, 54
  - retrieving stored readings, 46
  - revision query (firmware), 89
  - ROUTE:TERMINALS?, 58, 123
  - RS-232 interface
    - baud rate selection, 93, 148, 163
    - cables recommended, 150
    - commands, 153
    - connector location, 5, 150
    - connector pinout, 150
    - data format, 159
    - handshake protocol (DTR/DSR), 151
    - parity selection, 93, 164
    - pass/fail outputs, 70, 150
    - pin definitions, 150
    - selecting interface, 92, 162
    - TALK ONLY mode, 91, 160
  - rubber bumpers, removing, 23
  - S**
  - SAMPLE:COUNT, 77, 131
  - samples, number of, 77
  - SCPI
    - command summary, 105-111
    - compliance information, 168
    - data types, 158
    - language introduction, 154
    - status model, 134
    - syntax conventions, 50, 105, 155
    - version query, 90, 133
  - security code (calibration)
    - changing, 98
    - factory setting, 95
    - rules, 95
    - string length, 95
  - self-heating errors, 210
  - self-test
    - complete test, 13, 86
    - errors, 179
    - reading memory, 84, 86
    - power-on test, 13, 86
  - sensitivity, 226
  - sensitivity band (reading hold), 43, 82
  - serial interface (RS-232)
    - baud rate selection, 93, 148, 163
    - cables recommended, 95, 150
    - commands, 153
    - connector location, 5, 150
    - connector pinout, 150
    - data format, 159
    - handshake protocol (DTR/DSR), 151
    - parity selection, 93, 164
    - pass/fail outputs, 70, 150
    - pin definitions, 150
    - selecting interface, 92, 162
    - TALK ONLY mode, 91, 160
  - serial poll, 137
  - service request (SRQ), 69, 137
  - settling
    - delays, 204
    - trigger, 79
  - signal filter, 51, 214
  - single trigger, 42, 73
  - sliding-shelf kit, 24
  - slow ac filter, 51, 214
  - software (bus) triggering, 75, 127
  - specifications, 215
  - standard event register
    - bit definitions, 140
    - clearing, 141
  - status byte
    - bit definitions, 136
    - clearing, 136
    - summary register, 136

status register  
 commands, 144  
 description, 134  
 diagram, 135  
 enable register, 134  
 event register, 134  
 \*STB?, 138, 145  
 stop bits, 148  
 storing readings  
 functions allowed, 46, 84  
 number of readings stored, 84  
 retrieving readings, 46  
 storing readings, 46  
 string length  
 calibration message, 99  
 displayed message, 87  
 error queue, 85  
 identification string, 89  
 string parameters, 159  
 summary register  
 clearing, 136  
 definition, 136  
 support-shelf kit, 24  
 syntax conventions, 50, 105, 155  
 SYSTem:BEEPer, 88, 133  
 SYSTem:ERRor?, 85, 133

**T**  
 TALK ONLY mode, 91, 92, 160  
 temperature coefficient, 210, 224, 228  
 terminals  
 Ext Trig, 5, 83  
 Front/Rear switch, 2, 58  
 GPIB interface, 5  
 query setting, 58  
 RS-232 interface, 5  
 VM Comp, 5, 83  
 terminators, input message, 157

test  
 complete self-test, 13, 86  
 power-on self-test, 13, 86  
 reading memory, 84, 86  
 self-test errors, 179  
 test lead resistance, 38, 64, 198  
 thermal EMF errors, 198  
 threshold resistance, continuity, 52  
 transfer accuracy, 228  
 \*TRG, 75  
 TRIGGER, 75  
 TRIGger:COUNT, 78, 131  
 TRIGger:DElay, 80, 131  
 TRIGger:DElay:AUTO, 80, 131  
 TRIGger:SOURce, 73, 130  
 triggering  
 abort measurements, 76  
 auto trigger, 42, 73  
 commands, 130  
 delay, 79  
 external trigger, 42, 74, 83  
 flowchart, 72  
 front-panel, 42  
 idle trigger state, 76, 129  
 internal, 75  
 multiple readings (samples), 77  
 multiple triggers, 78  
 single trigger, 42, 73  
 software (bus) trigger, 75, 127  
 sources, 73  
 "wait-for-trigger" state, 76, 129  
 \*TST?, 86  
 tutorial  
 front-panel menu, 29  
 measurement, 197  
 twisted-pair connections, 201  
 two-wire ohms  
 connections, 17  
 math functions allowed, 63, 124  
 ranges, 17

**V**  
 vacuum-fluorescent display, 1  
 version  
 firmware, 89  
 SCPI, 90  
 VM Comp terminal, 5, 83  
 voltage  
 ac voltage  
 connections, 17  
 loading errors, 209  
 math functions allowed, 63, 124  
 ranges, 17  
 signal filter, 51, 214  
 dc voltage  
 connections, 17  
 input resistance, 53  
 loading errors, 199  
 math functions allowed, 63, 124  
 ranges, 17  
 voltage selector module, 15  
 Voltmeter Complete terminal, 5, 83

**W**  
 "wait-for-trigger" state, 76, 129  
 warranty information, *inside front cover*  
 weight, product, 222  
 wiring adapter (RS-232), 149  
 wiring connections  
 2-wire ohms, 17  
 4-wire ohms, 17  
 ac current, 18  
 ac volts, 17  
 continuity, 19  
 dc current, 18  
 dc volts, 17  
 dcv:dcv ratio, 44  
 diode, 19  
 frequency, 18  
 period, 18

**Z**  
 zero measurements, 59, 213