

The Advanced Photon Source Strategic Plan

Enabling frontier science in the national interest



October 1, 2021

The Advanced Photon Source is a U.S. Department of Energy (DOE) Office of Science User Facility operated for the DOE Office of Science by Argonne National Laboratory under Contract No. DE-AC02-06CH11357.

The Advanced Photon Source Strategic Plan

October 1, 2021

Table of Contents

1. Mission Statement	1
2. Vision Statement	1
3. Executive Summary	1
4. Introduction	3
5. Strategic Focus	5
5.1. X-ray Operations Improvements and X-ray Techniques Research and Development	5
5.1.1. Priorities	5
5.1.2. Implementation	7
5.1.3. X-ray Science Developments by Collaborative Access Teams	10
5.2. Accelerator Operations and Improvements, and Research and Development on New Concepts and Next-Generation Light-Source Technologies	11
5.2.1. Introduction	11
5.2.2. Accelerator Reliability	11
5.2.3. Accelerator Improvements	12
5.2.4. Accelerator R&D to Advance New Concepts and Next-Generation Light Sources	17
5.3. Infrastructure, General Operations, Engineering Support, and Other Miscellaneous Improvements	21
5.4. Mission Readiness – PSC Operations Portfolio	25
5.4.1. FY21 Project Execution Plan	26
5.5. User Processes and Scientific Access	26
5.5.1. Outreach to Users	27
5.5.2. User Support/Access	28
5.5.3. User Training	29
5.5.4. Proposal Review Process	29
5.5.5. Training the Future Science Generation	29
5.6. Human Capital and Workforce Development	30
5.6.1. Workforce Planning	31
5.6.2. Organization Capability Assessment (Talent Discussions)	31
5.6.3. Professional Development and Career Advancement	31
5.6.4. Core Values	32
5.6.5. Diversity, Equity, and Inclusion	32
5.6.6. Change Management	32
5.6.7. Summary	33
6. Summary and Outlook	33
Appendix 1: Beamlines at the APS	35
Appendix 2: User Data	36

1. Mission Statement

The mission of the U.S. Department of Energy Office of Science-Basic Energy Science's (DOE-SC-BES's) Advanced Photon Source (APS) at Argonne National Laboratory is to deliver world-class science and technology by operating an outstanding synchrotron radiation research facility accessible to a broad spectrum of researchers.

Our goals are to:

- operate a highly reliable third-generation synchrotron x-ray radiation source,
- foster a productive environment for conducting research,
- enhance the capabilities available to users of the APS facility,
- assure the safety of the facility users and staff and the environment,
- maintain an organization that provides a rewarding environment that fosters professional growth, and
- optimize the scientific and technological contribution to the DOE and society from research carried out at the APS

while maintaining a friendly, safe, diverse, and environmentally responsible workplace.

2. Vision Statement

The APS vision is to operate and develop world-leading hard x-ray user facilities for an international research community that will advance the forefront of x-ray science, transforming the possibilities for exploration of materials science, life sciences, chemical sciences, earth and planetary science, and cultural heritage in the 21st century.

3. Executive Summary

The APS at Argonne National Laboratory is a U.S. DOE-SC-BES scientific user facility. The core mission of the APS is to serve a multi-faceted scientific community by providing high-energy x-ray science tools and techniques that allow users to address the most important basic and applied research challenges facing our nation, while maintaining a safe, diverse, and environmentally responsible workplace. The APS is optimized to provide this nation's highest-brightness hard x-rays (i.e., photon energies above 20 keV). This makes it ideally suited to explore time-dependent structure; elemental distribution; and chemical, magnetic, and electronic states under *in situ* or *in operando* environments for a vast array of forefront problems in materials science and condensed matter physics, chemistry, and the life and environmental sciences.

The APS will continue to improve beamline performance to take full advantage of its existing source properties, as well as deliver new capabilities required by the large and scientifically diverse APS user community. The APS Upgrade Project (APS-U) will perform a major upgrade of the APS, implementing a multi-bend achromat (MBA) storage ring magnetic lattice that will increase APS x-ray beam brightness and coherent flux by 500 times over current values (depending on photon energy) and building new beamlines to take full advantage of the new source. The project also includes nine new feature beamlines (two of them in the Long Beamline Building under construction at the time of writing), enhancements to multiple existing beamlines, and insertion devices (IDs) tailored to the scientific need of each beamline.

This plan charts the path over the next five years for the improvements and R&D that will maintain the APS position as a world-leading hard x-ray synchrotron source while simultaneously preparing for the APS-U. The x-ray science strategy is focused on developing and improving brightness- and coherence-driven beamlines and techniques, high-energy beamlines and techniques, and timing and high-speed imaging capabilities as well as maintaining core capabilities and techniques. Methods and technique developments for x-ray science are described holistically where beamline instrumentation is viewed as a tightly integrated unit, spanning from source to optics to sample to detectors, all held together by effective and smart controls, and seamlessly coupled with analyses and visualization.

Accelerator operations planning will meet the current and future capabilities expected of a world-leading light source while maximizing efficiencies and delivering high beam availability to users. It is currently assumed that the present APS storage ring will pause operation approximately in mid-2023 and be replaced by the MBA lattice. Thus, this document aligns replacement and upgrade plans for accelerator systems to maintain a very high level of APS performance and reliability with R&D plans that incorporate the long-term transition to an MBA lattice source. This is accomplished in three main areas: accelerator reliability, accelerator improvement, and accelerator R&D to advance new concepts and next-generation light sources.

This plan includes engineering, maintenance services, and computing infrastructure that directly support and enable world-class performance of the APS accelerator and beamline complex, while ensuring a safe environment for APS users and personnel. The bulk of responsibility for general infrastructure, operation, and engineering support falls to the APS Engineering Support Division (AES). This division provides engineering, electro-mechanical, vacuum, safety interlock, and numerous other maintenance and support services, as well as design, operation, and support of the facility-wide computing infrastructure and enterprise business systems for the APS. All of these support efforts are in direct alignment with enabling world-class performance of the APS accelerator and beamline complex, while ensuring a safe environment for APS users and personnel. To successfully accomplish these activities, the AES strategy is based on four pillars: 1) an agile support role, 2) operational excellence, 3) engineering excellence, and 4) human capital.

This plan also includes a brief description of the current Operations Portfolio that was developed to capture and prioritize APS Operations-funded investments in general maintenance and obsolescence projects, in close coordination with the APS-U. While the Operations Portfolio projects are outside of the APS-U Project scope, the multi-year execution plan takes into consideration APS-U installation and commissioning schedule and effort needs.

A major focus for the user program in fiscal year (FY) 2022 will be to effectively and transparently communicate with the user community and the collaborative access teams (CATs) to provide information about the APS-U installation period and to solicit ideas from the community about how to minimize the significant disruption to scientific access that the installation period represents. The BES light sources have documented complex-wide beamline capabilities that will be available going into and throughout the APS-U installation period in order to provide APS users with clear options for alternate beamlines that will be available while the APS is offline.

Last, but not least, is our plan for identifying, implementing, and integrating workforce strategies throughout the directorate — a high-priority issue for PSC leadership. To be successful, the PSC must contend with the many variables that affect the organization's ability to successfully attain its strategic objectives and achieve its mission outcomes. In order to realize this, the PSC Directorate is strongly committed to talent management approaches that efficiently and effectively attract, engage, and retain human capital.

To be effective, the PSC Directorate focuses on five key areas:

- Workforce planning
- Organizational capability assessment
- Professional development, career advancement, and succession planning
- Diversity, equity, and inclusion (DEI)
- Change management

The PSC Directorate is committed to the highest standards in recruiting, hiring, mentoring, recognizing, rewarding, and providing professional advancement opportunities for all staff members while being an advocate for a diverse PSC community.

4. Introduction

The APS is one of five x-ray light sources (four storage ring-based sources: the APS, the Advanced Light Source at Lawrence Berkeley National Laboratory (LBNL), the Stanford Synchrotron Radiation Lightsource at the SLAC National Accelerator Laboratory, and the National Synchrotron Light Source-II at Brookhaven National Laboratory (BNL), and one free-electron laser (FEL), the Linac Coherent Light Source at the SLAC National Accelerator Laboratory, that are operated as national user facilities by the DOE-SC-BES.

Of the four storage rings, the APS operates at the highest electron energy (7 GeV) and has been optimized to be the source of this nation's highest-brightness source of storage ring-generated hard x-rays (i.e., photon energies above 20 keV). High-brightness hard x-rays can penetrate deeply into materials and can be concentrated efficiently in a small spot. This combination enables *in situ*, real-time studies of internal structures and chemical states in actual environments and under relevant operating conditions.

The APS is also the largest of the DOE light source facilities in terms of the number of beamlines and size of its user community. The APS facility comprises an accelerator complex, storage ring, beamlines, and supporting laboratory and office space. There are currently (FY21) 67 operating x-ray beamlines; 34 supported by APS operations and 33 of which are operated by the CATs. A CAT beamline is defined as a beamline where all (or a large fraction) of the funds do not come from the APS operations budget. For instance, the Nanoprobe beamline at Sector 26 is jointly supported through the Center for Nanoscale Materials (CNM) and the APS, but the majority of the funding *is not* from APS operations, so by this definition, the Nanoprobe is included in the CAT beamline count.

It should be pointed out that the staff that operate eight of the CAT beamlines (four at HPCAT-XSD/Sector 16, two at SBC-XSD/Sector 19, and two at GMCA-XSD/Sector 23) are members of the X-ray Science Division (XSD), but funding for those beamlines, including the effort costs, *does not come from the APS operations budget*. Sector 16 is supported by the National Nuclear Security Administration, Sector 19 by the DOE Biological and Environmental Research program, and Sector 23 by the National Institute of General Medical Sciences and National Cancer Institute of the National Institutes of Health.

The CATs are important partners with the APS as they not only provide additional funding to operate beamlines at the APS, but also make additional resources and expertise available to users in a wide variety of disciplines including life sciences, pharmaceutical research, geo- and enviro-science, high-pressure studies, and shock physics to name a few. The CATs are required to provide a fraction of the scheduled beam time (currently a minimum of 25%) to the pool of time available to the general user community. Several CAT-operated beamlines now serve as national resources and award 100% of their time to general users.

General users, who come from academia, industry, and government institutions, obtain beam time at the APS via a scientific peer review process. In FY20, the APS supported 4323 unique users (on-site and

remote/mail-in) from 49 U.S. states, the District of Columbia, Puerto Rico, and a host of nations around the world who conducted research that spanned the full range of fundamental and applied sciences across fields including materials science, biological and life sciences, geosciences, planetary science, environmental science, engineering, chemistry, and physics. Not surprisingly, the number of users was lower than that for FY19 (5426) due to the COVID-19 pandemic. In calendar year (CY) 2020, 2117 journal papers based on work done at the APS were recorded in the APS Publications Database as of August 20, 2021. Notably, macromolecular crystallographers utilizing APS x-ray beams deposit more protein structures in the Protein Data Bank than do researchers at any other light source in the world.

The APS is currently executing a project—the APS Upgrade, or APS-U—that includes installation of a 7-bend achromat magnetic lattice into the existing storage ring tunnel that will increase x-ray beam brightness and coherent flux by 2-to-3 orders of magnitude at x-ray energies of 20 keV and higher. This upgrade of the storage ring is a cost-effective approach to a “fourth-generation” storage ring as it will reuse a significant portion of the existing infrastructure accelerator, injection systems, and much of the beamline hardware. The project also includes nine new feature beamlines (two of them in the Long Beamline Building under construction at the time of writing), enhancements to multiple existing beamlines, and insertion devices tailored to the scientific need of each beamline. The current schedule calls for the APS to shut down for one year (the “dark time,” commencing in April 2023) for installation of the new storage ring lattice.

While the detailed science case and technical design for this upgrade are presented in other documents, the brightness and coherence increase from the APS-U in the hard x-ray region of the spectrum will revolutionize imaging, microscopy, and nanobeam science; high-energy methods; and high-wavenumber scattering techniques. The penetrating x-ray probes produced by the upgraded APS will transform *in situ* real-time studies of internal structure during synthesis and of materials functions in actual environments and under relevant operating conditions across a hierarchy of length scales from the atomic to the macroscopic. This upgrade will help maintain the APS world-leading position in the hard x-ray community for decades to come.

However, the APS must continue to maintain the excellent reliability and availability of the current accelerator and storage ring systems and support users before the start of the installation period. “The Advanced Photon Source Strategic Plan” is driven by the above responsibilities. The document comprises an outline of improvements and R&D to be undertaken by APS Operations during the next five years, preparing for the upgrade in the next 1.5 years and then, after the April 2024 end of the dark time, be ready to operate and maintain a significantly upgraded facility.

To achieve these goals, the APS will invest in improving an aging accelerator and beamline infrastructure while developing innovative capabilities and continuing to drive efficient mission execution. By creating a synergy between today’s improvements and tomorrow’s needs, the APS will enable operational capabilities for the next five years and continue to grow a scalable, forefront science program that will smoothly transition to take advantage of an upgraded accelerator source.

To summarize, the goals described in this strategic plan are comprehensive and have gone through a full facility-wide strategic prioritization process for resource allocation. However, for beamline investments, prioritization is a continuing process based on user needs and trends, and will necessarily involve ongoing, deep engagement with the APS user community and other stakeholders.

Finally, it is important to note that the APS divisions maintain more detailed strategic plans that are updated annually. See:

[APS Engineering Support Strategic Plans](#)

[Accelerator Systems Division \(ASD\) Strategic Plan](#)

[X-ray Science Division Strategic Plans](#)

5. Strategic Focus

5.1. X-ray Operations Improvements and X-ray Techniques Research and Development

The APS operates a suite of cutting-edge beamlines that address problems across a wide range of disciplines relevant to the needs of the U.S. scientific community. Modern scientific and technological challenges not only require the ability to gain insight about the properties of matter but must do so with spatial resolution down to a few nanometers, temporal resolutions reaching nanoseconds, and under *operando* or extreme conditions. To address this need, the APS long-term strategy includes building a new, low-emittance MBA x-ray source; developing beamlines and the ancillary capabilities needed to fully exploit this source; and fostering a broad-based and vibrant hard x-ray science community that provides international leadership in science enabled by this source.

Targeted research and development activities by APS staff lay the foundation for taking full advantage of the upgraded source, as well as delivering new capabilities. A key component of this strategy is leveraging the high-performance computing capabilities and expertise both within Argonne and across the DOE complex for comprehensive and timely analysis of large, complex, and multi-modal data sets. Furthermore, Argonne capabilities in nanofabrication, engineering, and computing play a central role in the development of hardware and software to fully utilize the APS-U source, including high-stability/high-precision instrumentation, state-of-the-art x-ray optics, advanced detectors, and methods in data management and computational x-ray science. The APS staff play a quintessential role in this effort by continuing to advance x-ray instrumentation, algorithms, methods, and techniques.

Keeping the APS at the forefront of scientific research requires the continued evolution of the beamline portfolio; the hiring, development, and retention of talented scientists, engineers, and technical professionals; and expansion of the depth and breadth of the APS user community. Investments must be made in beamlines, staff, and R&D to continue improving and expanding APS capabilities, and to preserve APS leadership positions in the hard x-ray sciences. These directions and investments are aligned with the four specific priority areas for the APS given below.

5.1.1. Priorities

Brightness- and Coherence-Driven Beamlines and Techniques

The APS source after the MBA upgrade will provide world-leading beam coherence and brightness at high energies (> 20 keV). These beam characteristics will greatly enhance imaging, microscopy (including coherent diffractive imaging), and correlative-dynamics experiments, which will make possible completely new measurements not feasible today. For example, the increased coherence at higher energies delivered by the APS-U will provide a 4- to 6-order-of-magnitude increase in the time resolution of x-ray photon correlation spectroscopy (XPCS), revolutionizing the ability to probe the dynamics of systems in attenuating sample environments, such as electrochemical cells with applications to energy storage. With lensless imaging approaches, it will be possible to achieve high resolution in large three-dimensional fields of view. Likewise, the high-intensity, focused APS x-ray beams will provide the ability to study nanometer-size voxels with chemical specificity in complex chemical environments.

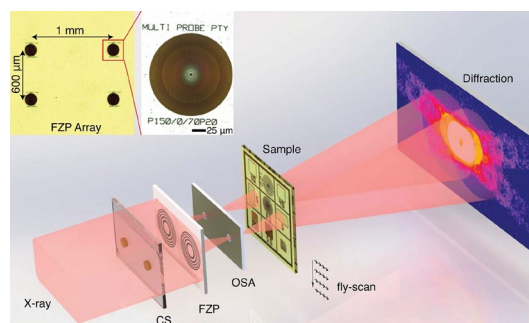

Fig. 1. Schematic of multi-beam ptychography. Such approaches could leverage APS-U to allow multiplexed lensless imaging for significantly increased throughput and imaging speed. Y. Yao *et al.*, *Sci. Rep.* **10**, 19550 (2020) ©2020 Springer Nature Publishing AG

The APS will work to develop, establish, and refine methods and techniques that take full advantage of the greatly increased brilliance and coherence that the upgraded APS will provide. For example, novel methods are being developed that will enable multiplexed data acquisition for lensless imaging that will significantly increase data acquisition times (see Fig. 1).

High-Energy Beamlines and Techniques

The APS is unique among current U.S. light sources in providing highly brilliant x-ray beams at high energies (> 20 keV), enabling deep penetration into matter, complex sample environments for *in situ* and *in operando* experiments, minimizing radiation damage, and providing precise structural information. Developments at the APS in superconducting undulator (SCU) technology, high-energy focusing optics, and new detection schemes have further pushed the spatial and temporal resolution limits achievable with high-energy x-ray methods. The APS staff have exploited these unique high-energy strengths to develop world-leading x-ray characterization tools for addressing problems in materials science, chemistry, condensed matter, and extreme conditions.

After the upgrade, the APS will have significantly increased degrees of coherence and enhanced flux densities at high energies. This will make it feasible to extend many x-ray techniques much further into the high-energy regime, particularly in areas such as imaging, microscopy, surface diffraction, etc. APS staff and their Argonne colleagues are developing the experimental and analytical tools that are required to apply such coherent methods at higher energies for applications such as strain-mapping of individual grains within polycrystalline matrix using coherent diffraction imaging or understanding atomic mobility during layer-by-layer growth using crystal truncation rod XPCS (see Fig. 2). The APS will continue to emphasize and invest in expanding such novel high-energy methods.

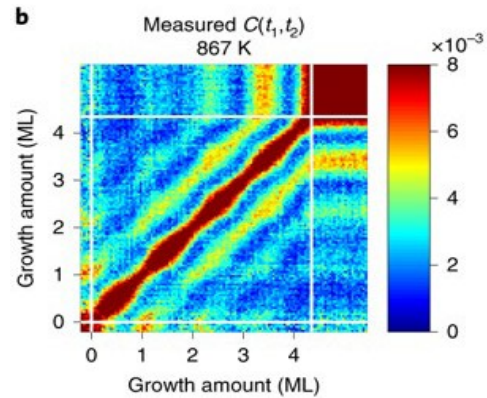

Fig. 2. Two-time correlation functions measured from two-dimension islands before, during, and after growth using a pink x-ray beam at 25 keV at the 12-ID-D beamline. Such work will increasingly be enabled by the high coherent flux at higher x-ray energies provided by the APS-U. G. Ju *et al.*, *Nat. Phys.* **15**, 589 (2019). ©2019 Springer Nature Publishing AG

Timing and High-Speed Imaging Capabilities

The APS provides several unique ultra-fast x-ray scattering, spectroscopy, and imaging capabilities for probing dynamic phenomena on 100-ps to microsecond time scales. High-speed imaging of single-event processes such as dynamic compression or additive manufacturing (see Fig. 3) has gained significant user interest. To retain the APS strength in timing measurements, the upgraded source will support a 48-bunch pattern with a large, intra-bunch spacing. Further, the APS has been developing advanced asynchronous data acquisition methods to enable spectroscopic timing experiments in 324-bunch mode. The ability to focus the full x-ray beam flux onto sub-micron spots will provide opportunities for new types of time-dependent studies in more-complex environments and on nanoscale heterogeneous systems, e.g., in energy

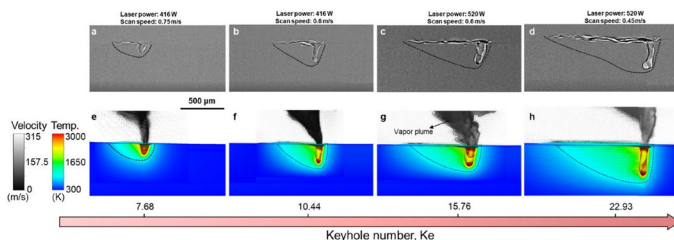

Fig. 3. Ultra-fast radiography of the additive manufacturing process, comparing multiphysics simulations (e-h) with experimental data to establish universal scaling laws to better predict porosity in 3-D metal printing. Z. Gan *et al.*, *Nat. Commun.* **12**, 2379 (2021), ©2021 Springer Nature Publishing AG

conversion processes. In addition, the increased coherence will significantly improve phase contrast in transmission imaging and enable high-flux projection microscopy that closes the gap between high-speed imaging with low spatial resolution and x-ray microscopy with poor time resolution.

Time-resolved techniques will continue to play a key role in an upgraded APS, and the APS will invest in timing and high-speed imaging, particularly where they are coupled with new approaches that leverage brightness, coherence, and/or high energies.

Core Beamline Capabilities and Techniques

The APS serves a large number of users across many diverse scientific fields who benefit greatly from excellent beamline capabilities and outstanding staff expertise. The availability of numerous x-ray characterization capabilities is essential for understanding the structure, morphology, elemental distribution, and chemical state of complex hierarchical systems, providing a key component in finding new functionalities. The APS will continue to optimize and invest in highly sought-after programs and facilities including, but not limited to, automated approaches for enabling multimodal inquiries into mission-critical scientific questions such as investigations of structural changes during battery cycling (see Fig. 4) and development of new catalysts. Such core x-ray capabilities coupled with *in situ* synthesis instrumentation provide ideal platforms for application of machine learning and artificial intelligence (ML/AI) approaches to accelerate materials discovery. The APS is working collaboratively with the Argonne programmatic divisions and the wider user community on a number of projects coupling techniques such as x-ray diffraction, pair distribution function, small-angle x-ray scattering, and x-ray absorption spectroscopy with ancillary characterization and modern computation to optimize synthesis pathways for new materials.

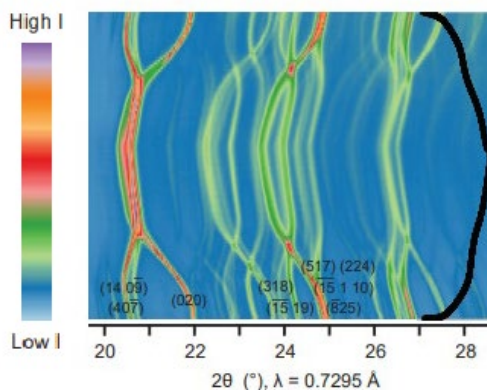

Fig. 4. Structural evolution of Nb-W-W battery electrode during *in operando* electrochemical cycling. K. Griffith *et al.*, *Nature* **559**, 556 (2018). ©2019 Springer Nature Publishing AG

Specialized support labs are essential for supporting this mission. The APS will continue to invest in labs for on-site sample preparation in dedicated environments for the highest level *in situ* and *in operando* research and for extreme-conditions research. The APS will work with the scientific user community to identify and respond to future requirements, including training and developing the user base as well as disseminating information through workshops, seminars, schools, etc.

5.1.2. Implementation

To accomplish the activities outlined above, the APS will continue to develop instrumentation and techniques for advancing x-ray science. Furthermore, the APS will maintain the productivity of the current beamline suite while simultaneously transitioning toward a portfolio of beamlines and instruments that will fully exploit the unique characteristics of the upgraded APS.

As the APS beamline portfolio evolves toward increased nanobeam- and coherence-based techniques, much more stringent technical requirements need to be met for beamline instruments (e.g., speed, stability, precision, frame rate, etc.). While the increased data rates enabled by the APS-U will permit experiments that are impossible today, they will require new methods for analyzing and visualizing extremely large data volumes. This forces the adoption of a holistic approach in instrument design, where instruments are a tightly integrated system spanning from source to optics to sample to detectors to

computation and visualization, held together by effective and smart controls, and performing experiments with flexibility, speed, and capabilities impossible only a decade ago.

To realize this vision, the APS is developing new experimental and analysis methods capable of taking advantage of such fast data acquisition. For example, the APS is pursuing novel applications of ML/AI for autonomous experimental control and large-scale data inversion, reduction, and abstraction. The PtychoNN (Neural Network) approach shown in Fig. 5 has the potential to replace the time-consuming conventional iterative ptychographic processes with deep neural networks. This approach has been shown to be up to 300 times faster than conventional methods and may require 5 times less data, speeding up not only reconstruction, but also data acquisition. The APS is working with the Argonne computation directorate on further scaling up such methods by porting them to next-generation ML/AI platforms and deploying them on leadership computing resources. Argonne's Leadership Computing Facility (ALCF) is standing up a new machine, which is expected to be operational in the fall of 2021, called Polaris, which will make on-demand, petaflop-scale computing available for developing the necessary acquisition, workflows, and infrastructure to tightly couple ALCF to the APS. The goal is to provide sufficient data streaming and reduction capabilities so that even the most compute-intensive APS-U applications can provide real-time feedback to either experimenters or the AI to effectively steer experiments.

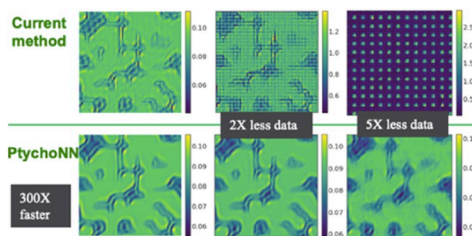

Fig. 5. PtychoNN machine learning approach for ptychography data reduction, and comparison of results to the conventional iterative phase retrieval approach. M. Cherukara *et al.*, *Appl. Phys. Lett.* **117**, 044103 (2020). © 2020 AIP Publishing LLC

The APS is also invested in a number of collaborative cross-complex efforts in the data, computation, and controls space. The APS has been systematically deploying the Brookhaven National Laboratory-developed Bluesky experiment control package at APS instruments. One of the key advantages of Bluesky is its built-in ability to tag measurements with comprehensive metadata that is necessary for the effective application of ML and AI. Bluesky also facilitates adaptive control and data streaming, allowing experiments to execute advanced analysis that will autonomously identify the most significant volumes within a sample and drive instruments to those regions in real time. For data processing and analysis, the APS is collaborating with the Advanced Light Source and the Center for Advanced Mathematics for Energy Research Applications at LBNL, as well as the National Synchrotron Light Source-II, the Linac Coherent Light Source (LCLS), and the Stanford Synchrotron Radiation Lightsource to develop and employ common software tools for various computation-intensive applications. The first deliverable for this project focused on integrating and deploying a common integrated XPCS controls and analysis software suite to all the BES light sources, and this approach is now being extended to tomography and ptychography. Together, these thrusts enable innovative x-ray techniques and scientific approaches that are orders-of-magnitude faster, more dose efficient, and more sensitive than those available today.

The APS is also investing in advanced optics and detectors and related infrastructure that will enable full use of the beam characteristics of the upgraded APS source. The optics strategy concentrates on the development of high-performance nano-focusing optics, such as high-efficiency zone plates, graded multilayer mirrors, and other diffractive optics; and of wave-front-preserving optics, including novel crystals and mirrors (see Fig. 6) and multilayer optics suitable for high x-ray energies. In addition, the APS collaborates with other light sources on concepts relevant to diffraction-limited light sources such as cryogenically cooled mirrors with LBNL, SLAC, and BNL, and characterizing perfect diamond crystals for a cavity-based, x-ray free-electron laser with SLAC. Advanced beamline optics simulation and optimization software, including the ability to simulate heat loads and their effect on x-ray optical-system performance, are critical for improving optics and, ultimately, beamline performance. Lastly, modern metrology tools such as the recently upgraded long-trace profiler and interferometer systems are essential to characterize and obtain the best performance from state-of-the-art mirrors and other optics for the APS-U and beyond.



Fig. 6. Flexure-based mirror bender with capacitive sensor readback that can be used for AI/ML optimization being developed in preparation for the APS-U. S. Mashrafi *et al.*, *SPIE* **11491**, 14910T (2020). © 2020 SPIE

Current x-ray experiments are often detector-limited rather than source-limited, with available detectors unable to take full advantage of the bright, high-energy x-ray beams produced by modern synchrotrons. The detector development strategy focuses on cutting-edge detectors that are unlikely to be commercially available, leveraging key partnerships with detector groups across the country and making use of unique Argonne resources. The APS detector R&D efforts comprise three areas: pixel array detectors, high-energy sensors, and emission detection. Current projects in these areas are the mixed-mode pixel array detector (MM-PAD) in collaboration with Cornell University; evaluation of germanium, cadmium zinc telluride, and perovskite high-Z sensors in collaboration with BNL, Cornell University, Northwestern University, and SLAC; and transition-edge sensors (TES) for high-energy-resolution emission detection applications for hard x-ray research in collaboration with the National Institute of Standards and Technology (see Fig. 7). The MM-PAD will provide the high dynamic range, low noise, high frame rate, and high stopping power for hard x-rays essential for extending coherence techniques to higher energies. Further, the need for x-ray pixel detectors with higher frame rates will stress the ability of detector designers to provide sufficient bandwidth to reach continuous frame rates in the 1-MHz regime. To address this need, the APS has been collaborating with the Argonne Mathematics and Computer Science Division on new strategies for maximizing the effective off-chip bandwidth by utilizing near-edge data compression that have yielded greater than 1-order-of-magnitude increases in throughput.

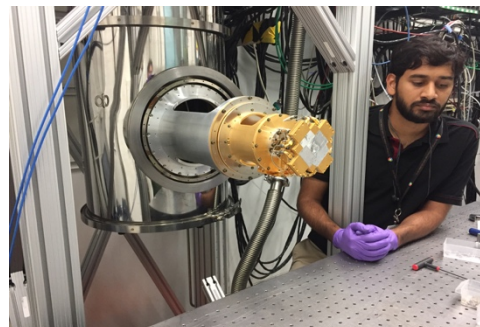

Fig. 7. High-energy superconducting TES emission detector being tested in 1-BM-C. T. Guruswamy *et al.*, *J. Phys. Conf. Series* **1559**, 012018 (2020)

The COVID-19 pandemic placed an emphasis on the rapid deployment of remote experimental control mechanisms for users. A remote non-VPN workstation access based on NX NoMachine was deployed on more than 140 workstations at 42 beamlines along with an access and access management portal for users and staff, respectively. The system allowed APS beamline staff to manage user access to beamline resources compatible with operational needs of the beamline and general user facility-access approvals.

The pandemic also pointed to significant opportunities for deployment of greater automation for broad classes of experiments, and enhanced telepresence and augmented reality tools to allow remote staff and users to interact immersively with on-site staff and users. Many of these developments will continue to be utilized post-pandemic, and the APS will continue to adapt and refine these new tools to provide mechanisms for increasing the efficiency and inclusivity to the APS scientific output.

The continued innovation and evolution of beamline capabilities including novel *in situ* and *operando* environments, coupled with advances in instrumentation, optics, detectors, and advanced computation will enable scientists to realize the full potential of an upgraded APS, providing an unparalleled insight into the structure, chemical state, and dynamics of matter.

X-ray Science Division goals for FY 2022 include:

- maintaining active and productive user programs on APS beamlines and developing innovative instrumentation that advances beamline capabilities particularly in the areas of high energy, coherence, and nano-focusing;
- expanding the remote and augmented telepresence operation and the automation capabilities of beamline instruments;
- supporting the APS-U Project in completing construction and commissioning of the APS-U Instrumentation, Development, Evaluation & Analysis (IDEA), and Advanced Spectroscopy and LERIX (Lower Energy Resolution Inelastic X-ray Scattering) beamlines; implementing a long-range R&D plan for optics and instrument testing on the IDEA beamline; initiating construction of the Polarization Modulation Spectroscopy beamline; and continuing to work developing the full suite of APS-U feature beamlines and enhancements;
- further deploying computational methods and data handling approaches integrated into the experimental workflow, including Bluesky, the APS data management system; streaming data analysis to Polaris and other leadership computing resources and machine learning; and exploring the applicability of edge computing to augment real-time data reduction;
- completing the deployment of the hard x-ray transition-edge sensor, energy-dispersive, multi-pixel detector; deploying the MM-PAD v2.1 with silicon and cadmium telluride sensors; and continuing the development of on-chip compression methods;
- upgrading metrology capabilities to be APS-U ready, applying the modular deposition system for fabrication of high-energy multilayer optics, and investigating the applicability of cryo-cooled mirrors for high-power-density applications at next-generation light sources; and
- addressing on-going obsolescence issues at the beamlines through a coordinated multi-year plan to replace key components, such as monochromator cryopumps, and implementing this plan in close coordination with the APS-U to identify clear responsibilities for particular sub-systems.

5.1.3. X-ray Science Developments by Collaborative Access Teams

This plan is primarily focused on the APS-operated, BES-funded beamlines. However, over the years, the APS has built very strong partnerships with members of the CATs. The funding sources for these CAT beamlines are diverse and vary from federal sources (National Science Foundation, National Institutes of Health, DOE Biological and Environmental Research, DOE National Nuclear Security Administration) and consortia of universities and/or industry. The collective operating budgets of over \$35 M per year make significant additional resources and expertise available to users in a wide variety of disciplines including the life sciences, pharmaceutical research, the geological and environmental sciences, high-pressure studies, and shock physics to name a few. Key developments for beamlines built and operated by the CATs also must be considered as those beamlines function as complementary assets to the BES program at the APS. While CAT developments will not be covered in detail in this plan, the APS will actively monitor and support proposed CAT upgrades. The APS-U will provide unique opportunities for these beamlines as well.

5.2. Accelerator Operations and Improvements, and Research and Development on New Concepts and Next-Generation Light-Source Technologies

5.2.1. Introduction

The APS accelerator complex is the backbone of the APS scientific program. It includes a 7-GeV, 1.1-km storage ring operating with a 100-mA electron beam; a full-energy booster synchrotron; a 450-MeV particle accumulator ring; a 300-MeV to 425-MeV pulsed linear accelerator (linac); and an S-band radio-frequency (rf) thermionic electron gun. The APS has the largest installed 352-MHz CW rf power system in the U.S. and the second largest installed pulsed S-band rf power system. The APS uses more than 1500 power supplies for various magnets, supports more than 45 IDs, and utilizes numerous precision diagnostic devices to maintain beam quality.

Maintaining the high reliability of APS accelerator operations presents significant challenges. The accelerator systems continually undergo improvements directed at meeting new needs of the scientific program. As noted previously, the APS has developed a technical design for a new storage ring employing an MBA lattice. Replacing the existing storage ring with a new ring is currently planned to start in 2023 and be completed in 12 months. The result will be a dramatic 2-to-3 orders-of-magnitude increase in x-ray brightness. Careful provisions have been made in the ASD strategic plan to align current accelerator improvements and upgrades with the needs of a new ring, thus balancing requirements of current and future APS operations.

The ASD strategic plan is based on the following goals:

- Continue to operate the APS with excellent availability and beam quality
- Prepare the APS accelerator systems and staff for the APS Upgrade
- Pursue research in accelerator science and technology to benefit x-ray science

5.2.2. Accelerator Reliability

The APS accelerator complex has been in operation for more than two decades. One of the challenges facing the ASD is maintaining reliable operation of the complex while preparing for the APS-U. Although the APS-U provides a new storage ring, the injector systems are undergoing relatively minor upgrades of individual components. By the time the APS-U is operational, much of the injector system will be over 25 years old, and in several cases using outdated or obsolete technologies. The ASD is currently implementing a plan to update as much of these systems as possible before the MBA upgrade without impacting operational reliability. The APS staff and management will ensure that this is done in the most cost-effective and efficient manner. Through dedication to timely upgrades and rigorous maintenance protocols, the APS has become one of the world leaders in accelerator reliability, with beam availability routinely above 97%. This requires continuous communication between technical staff and management to assess risks to reliable operation and to prioritize activities targeting high-risk issues.

For example, the APS linac, typically operated between 400 MeV to 500 MeV, has much of the original control system developed in the early 1990s. It is becoming increasingly difficult to identify spares and replacement components for these parts. A linac rf test stand is being installed in an auxiliary building that will allow for independent processing of rf components such as linac structures, waveguide windows, and SLAC energy doublers, and testing of new rf sources without impacting APS linac operations. This will also support development and commissioning of a modern linac controls system.

5.2.3. Accelerator Improvements

5.2.3.1. Magnetic Devices

The Magnetic Devices Group within the ASD is responsible for all APS magnetic systems, including over 45 undulator IDs, and is the world leader in superconducting undulator development. The team continues to improve undulator performance, meeting challenges for the APS and other light sources in the DOE complex. Future work is focused on development of three-way-position revolver undulators, improving construction efficacy of hybrid IDs to meet technical and construction goals for the APS and the APS-U, development of automated ID magnetic tuning procedures, and development of a novel ID mechanical system that will allow faster gap change and better control of “strongback” deformations.

In preparation for mass production of hybrid IDs for the APS-U, special attention is being given to development of U.S. industrial partners to handle the majority of ID assembly external to the APS. The Magnetic Devices Group continues to improve planar SCUs and is building a 3.8-m-long SCU using superconducting NbTi wire and a thin-wall vacuum chamber. A significant leap in SCU development will include the completion of NbTi SCU technology and transfer of that technology to an industrial partner for SCU fabrication outside of the APS. The group is also designing SCUs using Nb₃Sn wire that provide even broader x-ray tuning ranges, and a high-temperature superconductor for a new generation of SCUs.

This group continues to advance the development of SCUs for polarization control. The next generation of polarizable sources is the Super Conducting Arbitrary Polarizing Emitter (SCAPE), Fig. 8. The SCAPE consists of horizontal and vertical undulators offset by a half period. By powering the coils in various configurations, the SCAPE can produce linear and elliptically polarized beams. Currently under development is a scheme for switching polarizations for a user beamline from two devices by varying the beam orbit. This is shown schematically in Fig. 9, where the polarization is selected by having two SCAPE devices with opposite polarizations and changing the angle of the beam orbit through the two SCAPE devices to allow the desired polarization to exit the beamline. This scheme is enabled by the expectation that a fast orbit feedback system, currently under development for APS-U, will be able to remove any residual beam motion from the beam so that this switching process is transparent to other users.

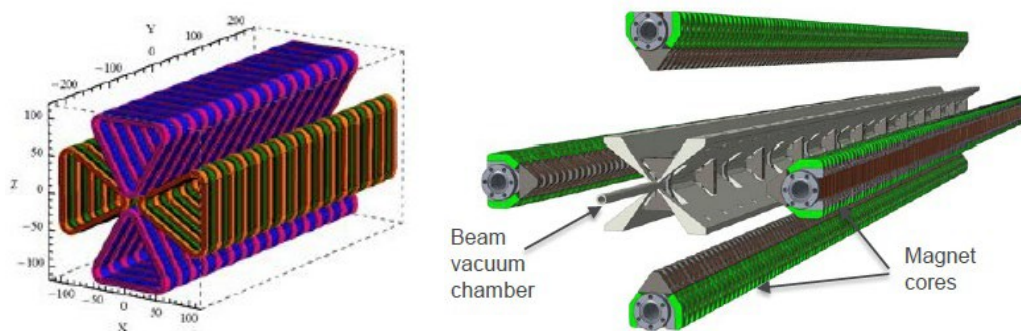

Fig. 8. (Left) The Radia Model for the SCAPE SCU magnets. Horizontal and vertical fields are shifted by a half period and can be powered arbitrarily, allowing variable polarization. (Right) A mechanical drawing of the SCAPE assembly. The x-wing vacuum chamber allows extraction of heat generated by the beam.

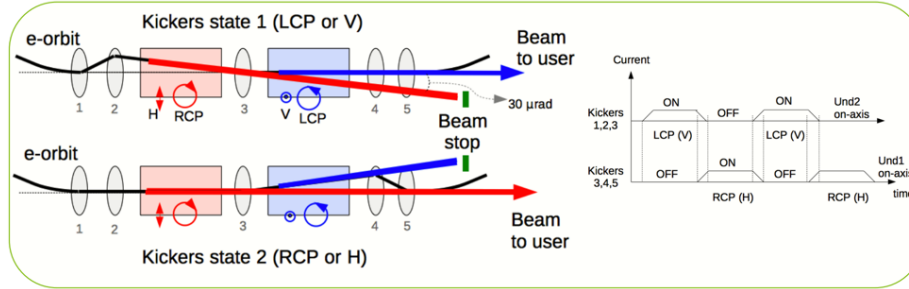

Fig. 9. A schematic view of the beam orbit switching method for selecting the two polarizations. This is the planned approach for the APS-U.

5.2.3.2. Radio-Frequency Systems

The RF Group within the ASD maintains and improves the rf system reliability and lifetime for all of the APS accelerator systems by addressing aging, obsolescence, and performance issues, thus allowing the existing hardware to provide reliable performance up to the installation of the APS Upgrade and beyond. Specific attention is given to identifying and replacing weak and aging components, and to proactive maintenance of the 352-MHz storage ring rf systems.

The strategy for addressing obsolescence of the storage ring rf system is to transition from high-power klystron tubes to solid-state technology with the potential to provide higher efficiency, longer lifetime, and lower maintenance and ownership costs than traditional klystron power amplifiers. Laboratory Directed Research and Development-funded research has led to a design consisting of a combined network of individual 2-kW amplifiers with a total power of up to 200 kW. These efforts have included purchase of a 30-kW prototype from industry that passed a series of tests over the past year with flying colors. In addition, both cavity and waveguide combiner networks were tested using a 30-kW amplifier and a klystron in a “back-feed” mode where 200-kW power was fed into the output of the combiner network. All tests performed within expectations. The cavity combiner configuration (see Fig. 10) has been selected and the first 200-kW unit has been fully specified and is currently out for bid from industry. The next step will be to prepare the APS infrastructure for installation and testing of this unit in the APS storage ring before the APS-U installation period. A nominal plan has been developed for procurement of two solid-state units per year following the storage ring demonstration that will allow for replacement of the current klystron-based system before the stock of klystrons is depleted, illustrated in Fig. 11.

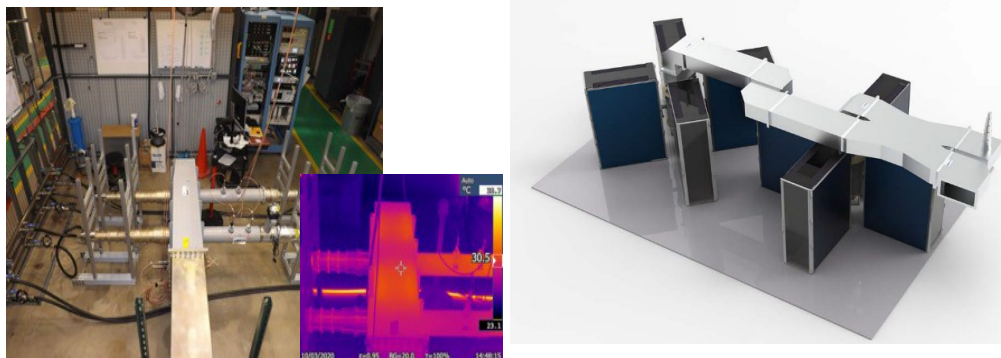

Fig. 10. (Left) The photo shows the “back-feed” test of the waveguide combiner. The inset shows an infrared photo indicating rf heating of the network. Results were in excellent agreement with modeling. (Right) The rendering shows the concept for a 200-kW amplifier. Each rack contains 15 2-kW amplifiers that are combined in the combiner cavity hidden below the waveguide. The first prototype amplifier was tested on the combiner cavity late in 2019.

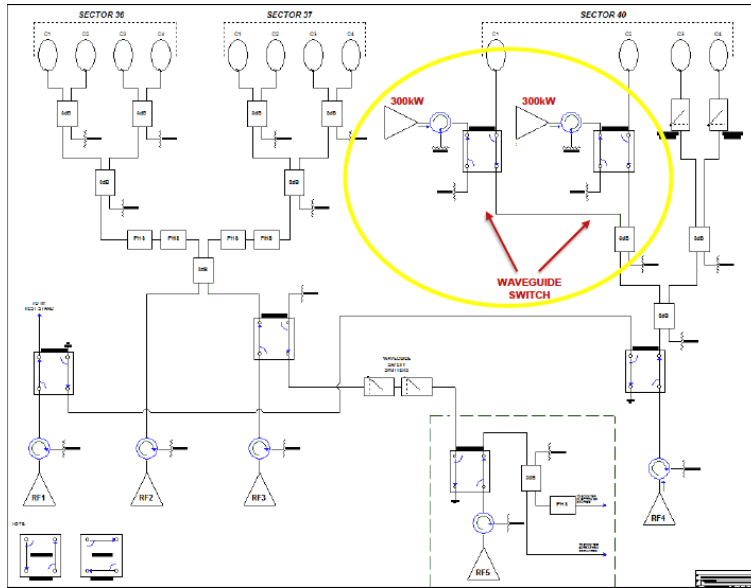

Fig. 11. The transition plan to solid-state rf amplifiers will occur over the decade beginning from 2021. The schematic above shows the planned hybrid configuration of the rf system in 2024, following the APS-U installation.

Another area of emphasis is addressing obsolescence issues in the various rf systems in the APS storage ring and injectors. A number of improvements to the particle accumulator ring harmonic rf system are being implemented that will enable the higher stored bunch needed for APS-U operation. An initiative to upgrade the APS linac rf systems has also begun. These improvements include:

- gradual replacement of the aging, home-built, pulsed high-voltage modulators with commercial modulators;
- gradual replacement of the current linac klystrons with higher peak-power klystrons;
- upgrade of the obsolete linac hybrid, analog, low-level rf controls with modern digital controls;
- upgrade of the obsolete timing controls to a system more compatible with the upgraded APS-U timing system;
- general replacement of other obsolete linac systems including power supplies and some diagnostics as needed; and
- set-up of a linac rf test stand to allow testing and conditioning of rf components without potential interruption to APS operations.

The ASD also maintains several rf test stands for testing components and developing new concepts. A 352-MHz rf test stand is utilized on a routine basis to condition and test new “green” tuners, couplers, and dampers in order to maintain a stock of conditioned and verified spare parts for the 352-MHz rf cavities.

5.2.3.3. Power Supplies

The ASD Power Supplies Group will continue to identify and replace aging power supply hardware before it impacts operations. This will be achieved by continuing proactive maintenance, continuing the thermal imaging program to identify any overheating parts and electrical connections and repair them before an actual failure, and thoroughly testing all power supplies including stress tests during machine start-up before each user run to ensure reliability for operations. The ASD will continue to closely monitor the condition of power supply equipment during operations, and schedule repair and replacement during machine interventions for equipment that has shown signs of elevated temperatures, voltage ripples, and/or communication issues. Examples are rising temperatures of the aluminum electrolytic

capacitors in power converters and communication issues with power supply controllers caused by increased voltage ripples from the low-level-control power supplies. Obsolescence of a large number of components is a long-standing issue. Next in line is replacing the programmable logic controllers, the GESPEC power-supply controllers, and digital signal-processing controllers. Many commercial power supplies utilized in the injectors (particularly in the linac) are close to 30 years old. The Power Supplies Group will replace those power supplies that are not supported by vendors. New commercial power supplies will not be 100% compatible with the original ones, so in-house solutions will be developed—in particular for many kicker power supply systems.

5.2.3.4. *Beam Diagnostics*

The ASD Diagnostics Group maintains and upgrades existing storage ring and injector diagnostics systems addressing aging, obsolescence, and performance issues. The group's primary Operations goal is to provide reliable performance of diagnostic instrumentation up to the APS-U installation period and beyond. For the APS-U, the focus is on completing the final design for all systems including beam-position monitors (BPMs) and BPM electronics, orbit and multi-bunch feedback systems, beam-size monitors, current monitors, and APS-U-specific injector upgrades including the booster-to-storage ring transport line redesign. Through the APS-U installation and commissioning periods, it is also planned for Operations-related injector upgrades to address various instrumentation obsolescence and reliability issues. Part of these upgrades will include new BPMs and current-monitoring electronics for the linac, particle accumulator ring, booster, and transport lines; new linac beam-rf phase detectors for linac phase feedback; and the current-monitor interlock as part of the radiation safety system. Finally, the plan is to leverage injector instrumentation upgrades to support the Linac Extension Area, such as using the new BPM and current monitor systems developed for the linac and transport lines.

5.2.3.5. *Accelerator Operations and Physics*

The Accelerator Operations and Physics Group (AOP) is the main source of accelerator physics theory and simulation in order to understand and improve the APS electron beams. Formerly, managing reliable operation of the APS accelerator complex was part of the AOP Group mission, but now it is the responsibility of the separate Main Control Room Group within the ASD. The AOP Group stresses thorough automation of machine operation and analysis, since these are the keys to high reliability. For example, the AOP Group has improved real-time detection and monitoring of malfunctioning power supplies and BPM electronics to further enhance orbit stability by removing the malfunctioning devices quickly from the orbit feedback system in order to facilitate repairs. Other automation improvements include beam-dump analysis, injection optimization, and lattice and filling pattern switching.

In preparation for APS-U operation, the AOP Group and other groups in ASD are using the existing APS to simulate APS-U conditions in several key areas. One of the important issues to better understand is the effect of the impact of the APS-U beam on the various collimators that will be added to the vacuum system that protects the vacuum chambers. Thermal analyses of beam strikes on a collimator have shown that the beam power density is sufficiently high to melt the collimator and essentially drill through the material. Over the past two years, a series of experiments were jointly conducted by the AOP Group and the Diagnostics Group, where the electron beam was focused to a smaller transverse size and directed onto a test collimator that was inserted into the beam. The collimator was externally imaged in real time to observe the effect of beam impacts on either aluminum or titanium portions of the collimator. Figure 12 (left) shows a frame of the video recording corresponding to the beam impact. The glowing line is the light emitted from the glowing metal. Small ejecta are observed in the image. Figure 12 (right) is a picture of the test collimator after an extended study following beam strikes at varying current levels. This section is under metallurgical analysis. Experiments and analysis continue in order to understand this effect in detail.

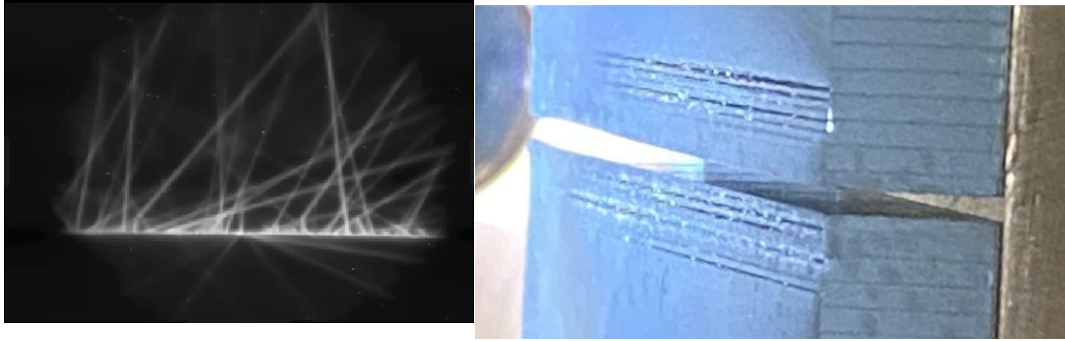

Fig. 12. (Left) The test collimator during a beam strike captured from a frame of the recorded video. Beam moves from left to right. Ejecta are observed as small flares from the molten metal. (Right) A picture of the test collimator after an extended study following beam strikes at varying current levels. This section is under metallurgical analysis.

Another area of focus in preparation for the APS-U is the subject of beam-ion instabilities. In this instability, ionized gas molecules resonate in the electric fields of the electron beam, causing electron beam motion and eventual emittance growth. Simulations of this effect show that the beam-ion instability could be a problem for the nominal 324-bunch fill pattern for the APS-U. One proposed solution that appears to solve the problem is to modify the fill pattern with small gaps to disrupt the ion motion and “guard” bunches (i.e., larger bunches at the edges of the gap) to mediate the beam loading transients induced by the gaps. Although this solution is effective in simulations, the aim was to demonstrate the effect experimentally using the existing APS storage ring. In the experiment, an intentional gas leak of N_2 gas was added to the storage ring in the Sector 25 straight section to raise the local pressure by two to three orders of magnitude. Strong vacuum pumping on either side of the straight section limits the pressure “bump” locally. A schematic of the experimental setup is shown in Fig. 13 (left). This setup allows injection of nitrogen gas and creates a condition where a beam-ion instability can occur. One of the signatures of the instability, which typically first occurs in the vertical plane, is the electron beam oscillating at the characteristic ion frequency. Shown also in Fig. 13 (right) is a plot of the vertical betatron sidebands during an ion instability, with the peak of the spectrum near 3 MHz to 4 MHz. This measurement was done at a range of currents up to 200 mA. A test of the guard bunch fill pattern for the same conditions shows no instability, providing strong support for the proposed mediation plan for the APS-U. Further studies will continue with the goal of further characterizing the beam-ion instability.

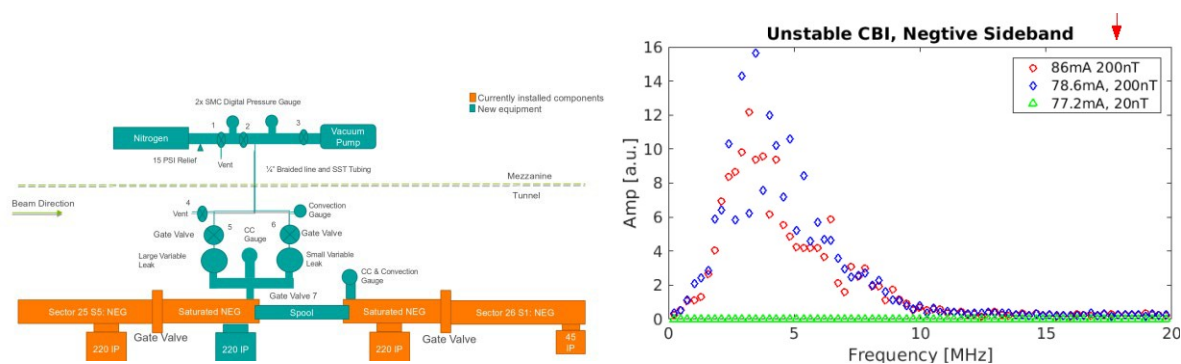

Fig. 13. (Left) A schematic of the gas injection setup for a controlled leak in Sector 25 of the storage ring. Strong vacuum pumping on either side of the injection limits the vacuum “bump” to a small region. (Right) The spectrum of unstable vertical sidebands at increased vacuum pressure. The peak between 3 MHz to 4 MHz corresponds to the expected ion frequency for these beam conditions.

The ASD is a world-leader in modeling storage ring light sources with the continued development of the **elegant** code and a related suite of tools. The AOP Group continues improving and enhancing high-performance computing accelerator simulations while making these state-of-the-art codes available to the

entire accelerator community, benefiting many accelerator facilities and projects beyond the APS and the APS-U. One of the highlights over the past year has been the addition of a new module, **ioneffects**, that includes the creation and motion of ionized gas species for the modeling of the beam-ion instabilities described above. This module includes the detailed vacuum profile of the accelerator as determined from other codes such as MolFlow. Specific future plans for **elegant** include adding electron beam polarization tracking and increasing parallelization in simulation codes and SDDS tools; further development of a graphics processing, unit-based version of **elegant**; and continued benchmarking of single-particle and collective effects.

5.2.3.6. Main Control Room Operations

The Main Control Room (MCR) operations staff serves on the front line of the operation of the APS accelerator systems and are responsible for operation of the entire accelerator complex. Over the past year, the MCR operations staff was moved to its own group in order to improve its visibility within the ASD and the APS in general. The MCR staff maintains beam stability and stored beam injected current. It operates all of the injection system (linac, particle accumulator ring, and booster) and the main storage ring. The MCR is primarily tasked with prompt recovery of beam upon a loss as well as general communication of beam status with users, but also is responsible for:

- user steering and beam optimization,
- group lockout-tagout and operation of the Access Control Interlock System to prevent personnel exposure to ionizing radiation,
- approval and coordination of work performed on the accelerators,
- coordination between various technical groups,
- reviewing and authoring dozens of procedures for operation of the various technical groups, and
- implementing policies and operating standards as set forth by the machine managers.

5.2.4. Accelerator R&D to Advance New Concepts and Next-Generation Light Sources

The APS has an earned reputation for staying on the cutting edge of accelerator science and technology that is beneficial for Argonne and the other DOE light source facilities. A suite of accelerator R&D programs focused on versatile, cost effective, and energy efficient future light source ensures that the U.S. and the APS continue to maintain this competitive edge.

The APS core strategy is to perform high-impact accelerator research by concentrating on several key areas that maximize key APS strengths: sophisticated high-fidelity simulation, development of advanced insertion devices, and innovative ideas for improved accelerator performance. While the main path forward focuses on an MBA lattice, opportunities also exist to explore whether the APS can supplement that with additional capabilities for use by specific user groups and for activities beyond the APS Upgrade.

Another component of the ASD strategic plan is innovative accelerator R&D advancing cutting-edge accelerator science and technology in the area of synchrotron light sources and other accelerator research areas beneficial for the greater accelerator community. The ASD has established leadership in several areas of interest to future light sources. Each of these are highlighted in the sections below.

5.2.4.1 Nb₃Sn Superconducting Undulators

The ASD is developing the first full-scale device based on Nb₃Sn wire with a promise of 30% higher field vs NbTi SCUs. Nb₃Sn superconductor has an excellent record of development in high-field magnets for applications in high-energy physics. For this reason, ASD has partnered with Fermilab for this program; this sister DOE laboratory provides expertise for heat treatment of the wound SCU cores. Testing of a 0.5-

m prototype is under way with the goal of beam test in the APS by installing a 1.2-m device in place of an existing SCU prior to the APS-U long shutdown. Shown in Fig. 14 is a recent photo of the treated SCU core. Extra care has been taken to treat the core with an insulating material (the white coating) and for extra fine machining to avoid any damage to the sensitive Nb₃Sn wire.

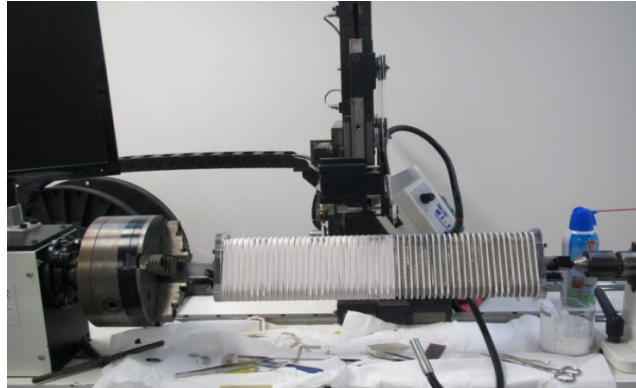

Fig. 14. Shown here is a magnet with mica insulations, during winding.

5.2.4.2 Cavity-based X-ray Free-Electron Lasers

With the advent of the high-repetition-rate x-ray FEL lasers such as the LCLS-II, several schemes for improving the longitudinal coherence of the x-rays have appeared, which depend on resonating the x-rays in an optical cavity based on high-purity diamond mirrors. A collaboration between Argonne and SLAC has formed with the three-year goal of building an optical cavity and demonstrating it on the LCLS-II Hard X-ray Research (HXR) FEL and using it with the high-repetition-rate superconducting linac when available.

A detailed schematic of the proposed cavity-based x-ray free-electron laser scheme is shown in Fig. 15. The electron beam passes through an undulator. Some of the created lasing x-rays resonate in the optical cavity with a path length corresponding to the distance between electron bunches. As the optical cavity fills, the interaction of the x-rays with the electron beam improves the longitudinal coherence of the x-rays, similar to an optical laser. The challenge is that, to fill the cavity, diamond mirrors of extremely high quality are required; challenging as well are the mechanical tunability and stability of the mirrors. As an initial test, the plan is to operate the LCLS copper linac with two bunches in a pulse with a separation equal to the cavity path length.

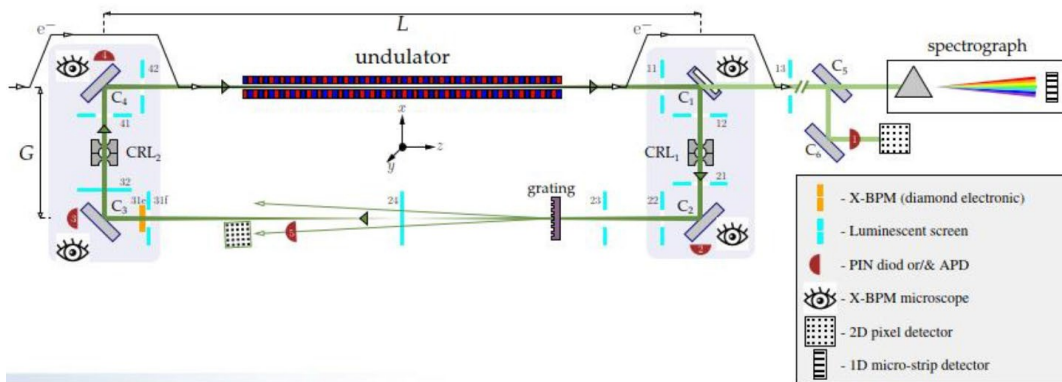

Fig. 15. A schematic diagram of the cavity-based, x-ray free-electron laser setup planned in the LCLS HXR FEL line. Small chicanes bring the electron beam around the diamond mirrors into the optical cavity. The path length of the cavity is adjusted to be the distance between electron bunches. Each of the mirrors is mounted on nano-positioning actuators to allow tuning of the cavity. The cavity is fully instrumented to diagnose the performance.

5.2.4.3 High Average Brightness Photoinjectors

Argonne has adopted the superconducting rf gun originally developed at the University of Wisconsin-Madison as part of a BES-funded R&D project with the goal of using the existing cryoplant in the Argonne Physics Division Accelerator Development and Test Facility (ADTF) to complete the demonstration and characterization of this gun. The gun was shipped to Argonne in December 2019 and underwent modifications to allow connection to the ADTF cryoplant and preparation for first cooldown by the end of 2020. Shown in Fig. 16 is a cross-section schematic of the gun and cryostat along with a photo of the gun in the Argonne Physics Division clean room undergoing preparation.

Unfortunately, the progress in 2020 was slowed by repairs on the tuner bellows that were damaged in shipping. Furthermore, once the cavity was cooled, an usually low Q of about 10^7 was measured when values of 10^9 were expected. Upon further inspection, a layer of Nb_3O_5 was found inside the cavity, probably from a plasma cleaning cycle performed several years prior. The dielectric properties of this oxide layer are responsible for the reduced Q -values that were measured at Argonne and previously at SLAC. Shown in Fig. 17 is a plot of cavity performance vs gradient after a high-pressure rinsing of the cavity body to remove the oxide contamination. The gun achieved a reasonable gradient of 15 MV/m following a series of pulsed rf conditioning cycles, completing the originally supported R&D program. It is believed that the gun could reach a higher gradient if a full cleaning of all cavity components is carried out along with light chemical polishing of the cavity.

This project at Argonne was a collaboration between the ASD, the Argonne Wakefield Accelerator, and the Superconducting RF Group within the Physics Division. Although this project is formally ended, this led to a follow-on project to build the LCLS-II High-Energy Upgrade superconducting rf gun in a collaboration between Argonne, Michigan State University, and Helmholtz Zentrum Dresden that begun in late FY21.

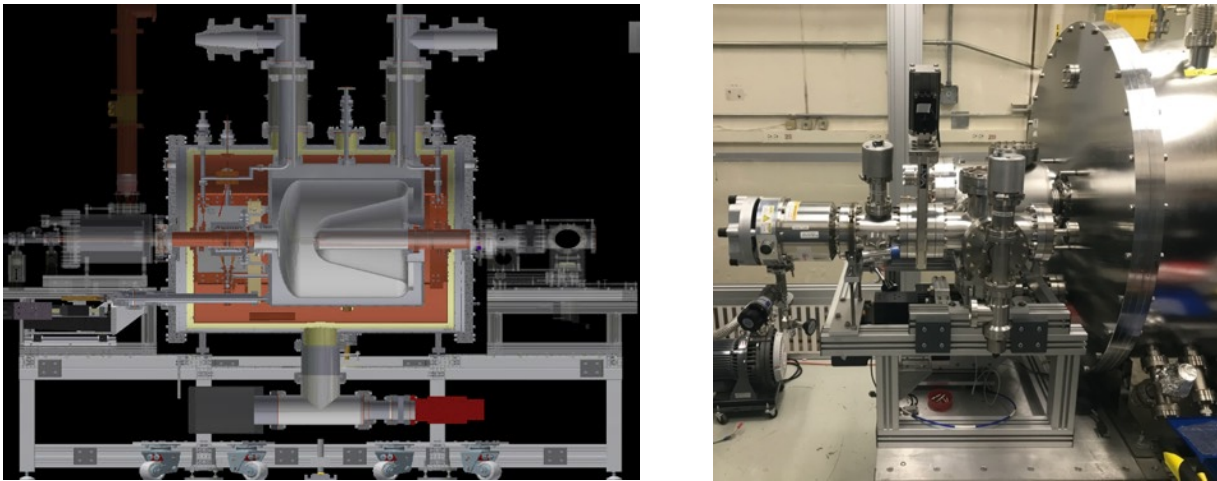

Fig. 16. (Left) A schematic view of the Wisconsin FEL gun. (Right) A photo of the gun under preparation in the Argonne Physics Division clean room facilities.

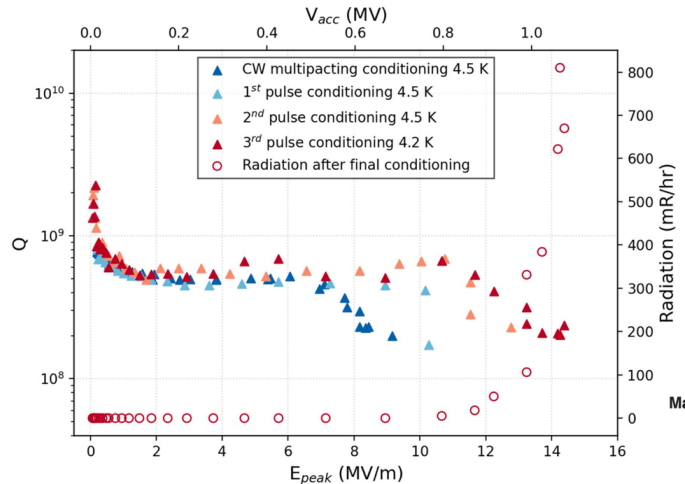

Fig. 17. Final results of the Wisconsin FEL gun performance following the repairs and high-pressure rinsing. The gun reached a gradient of about 15 MV/m at the cathode following a series of pulse conditioning cycles. It is possible that the gun could achieve higher gradients with a complete cleaning of all components and light chemical polishing.

5.2.4.4 Compact Accelerators for Future Light Sources

There has been tremendous progress in compact acceleration schemes over the past decade with concepts ranging from laser- and beam-driven plasmas to dielectric and corrugated wakefield acceleration. The vision at Argonne has been focused on high-gradient compact accelerators that provide high-energy transfer efficiency, relatively low fabrication cost, and sufficient beam quality for lasing in an FEL with a path towards high repetition rates of 10s of kHz and the eventual goal of a lower cost, multi-user x-ray FEL facility that can address the most pressing problems in science. The concept, funded by Laboratory Directed Research and Development awards, is to use a high-frequency (180-GHz) collinear wakefield accelerating (CWA) structure based on a corrugated circular waveguide. A large drive bunch creates a wake that accelerates the trailing witness bunch. A schematic of the concept is shown in Fig. 18 (left). A high-repetition-rate electron gun creates a drive and witness beam, which is accelerated to 1 GeV in a superconducting rf linac. However, from there the beam is switched into an array of compact CWAs where it is accelerated to higher energy and fed into individual FELs. A photo of a sample corrugated CWA structure is shown in Fig. 18 (right). Recent work has focused on the fabrication and characterization of this structure. Each accelerating module is envisioned to be a 0.5-m length of corrugated waveguide made with electroforming techniques. Each structure is attached to water-cooled copper fan-blocks, which are then embedded in a quadrupole wiggler. The quadrupole wiggler is critical since it provide a periodic FODO array that stabilizes the drive beam from beam breakup instabilities.

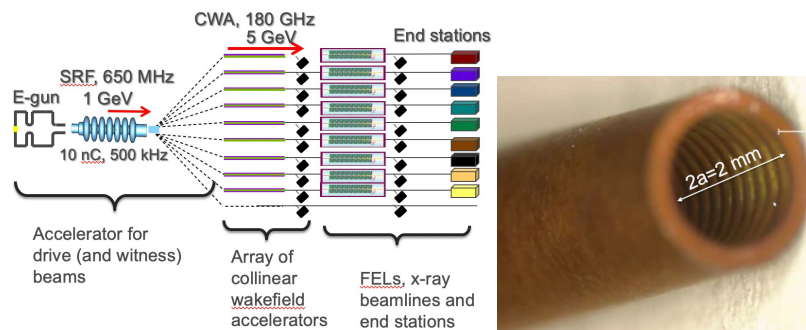

Fig. 18. (Left) A schematic view of the vision for a compact multi-user FEL facility. (Right) Photo of the corrugated accelerating structure fabricated using electroforming techniques.

Each module is being designed to provide about 50 MeV of acceleration. Engineering drawings of each of these pieces are shown in Fig. 19. Each 0.5-m accelerating section is connected with a transition section that serves to provide beam position measurements and extract higher-order-mode power from the beam, as well as mechanical bellows.

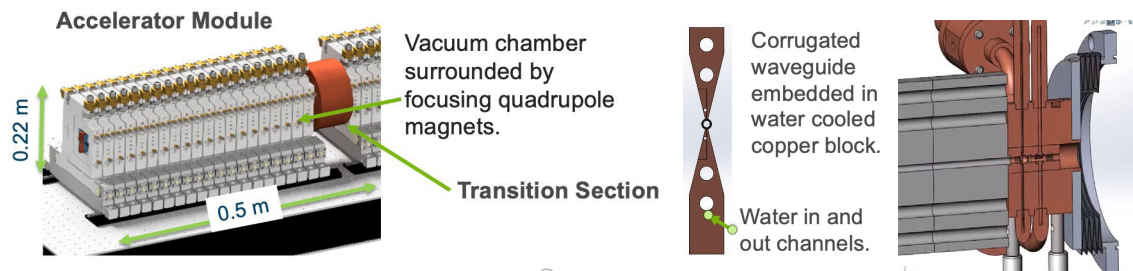

Fig. 19. (Left) An engineering computer-aided design drawing of a 0.5-m accelerating section. The vacuum chamber is surrounded by the periodic array of miniature quadrupoles (the quadrupole wiggler). (Middle) The 2-mm-diameter CWA is embedded in a water-cooled copper block that allows operation at higher bunch repetition rate. (Right) Each accelerating section is connected via a transition section that provides higher-order-mode damping and beam position measurement.

5.3. Infrastructure, General Operations, Engineering Support, and Other Miscellaneous Improvements

The APS continues to reinforce a vision for safe and predictable operations. Safety incidents are addressed promptly by PSC management through a variety of Argonne-wide initiatives, such as the creation of an Electrical Safety Manual and revised Qualified Electrical Worker training in FY18. These were followed by initiatives in FY19 that saw the creation of a Work Planning & Control Manual and a Controlling Hazardous Energy Manual.

Local PSC Directorate safety augmentations include increased observation/conversations; SMART-card targeted observations rolled out across the directorate; continuing use of the pre-job brief; and high-risk work reviews supported by a register to capture and communicate high-risk work, which was adopted by Argonne as the High-Risk Work Register in 2019 and later became the Argonne Management Awareness Tool.

The design and safety committee structure was revised in FY19, reducing over 13 separate standing committees down to a total of five within the PSC Directorate. A single PSC Design Review Committee has accommodated a significant (anticipated) increase in design review load due to the phase maturity of the APS Upgrade Project. In 2020, a total of 103 reviews were processed by the PSC Design Review Committee and 80% of these reviews were related to the APS-U.

The bulk of responsibility for general infrastructure, operation, and engineering support falls to the AES Division. The division provides engineering, electro-mechanical, vacuum, safety interlock, and numerous other maintenance and support services, as well as design, operation, and support of the facility-wide computing infrastructure and enterprise business systems for the APS. All of these support efforts are in direct alignment with enabling world-class performance of the APS accelerator and beamline complex, while ensuring a safe environment for APS users and personnel. The division strategy is summarized in the graphic below (Fig. 20).

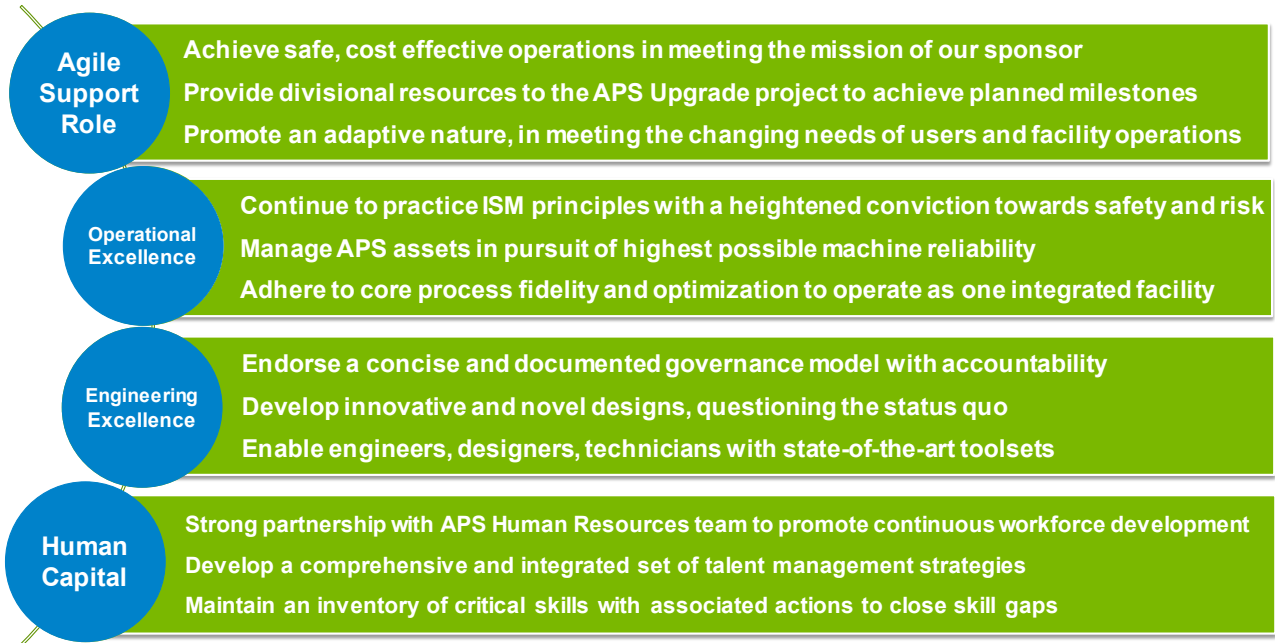

Fig. 20. The AES Division summarized strategy across four primary tenets.

The AES Division also acts as the *de facto* liaison to many of the Argonne service directorates. In FY18, a large effort was undertaken in concert with the Argonne Infrastructure Services Directorate to contract with an independent architectural/engineering firm for a complete characterization and assessment of all infrastructure related to the APS, commonly referred to as the 400-series of buildings that comprise the bulk of the APS. This included, but was not limited to, building foundations, superstructures, roofing, interior construction, mechanical systems, electrical systems, specialty systems, and associated utilities not included in a prior Argonne-wide utility master plan.

The result was a comprehensive needs-assessment prioritized by urgency, and reviewed and endorsed by both APS Operations and the APS-U to yield a framework order by which infrastructure needs can be addressed leading up to, during, and after the downtime associated with APS-U implementation [the “Advanced Photon Source (APS) Infrastructure Master Plan Volume 1,” Fig. 21, left].

The projects identified by the needs-assessment are further characterized by recommended funding source, dependent on scope, magnitude, and funding level estimated by the architectural/engineering firm and reviewed by the Infrastructure Services Directorate. The listing provides a clear picture of near-term site demands as well as long-term improvements to promote reliable operation of the APS up to and after APS-U implementation.

Advanced Photon Source (APS)
Infrastructure Master Plan
Volume 1



Argonne National Laboratory

APS Infrastructure Master Plan
Argonne Project No.: JSTD-129-W-T002
BMcD Project No.: 104634

Revision 0
8/7/2018



Fig. 21. Left: cover of the “Advanced Photon Source (APS) Infrastructure Master Plan Volume 1.” Right: completed replacement (400,000 ft²) of the storage ring roof in 2021.

Significant progress has been made on execution of the APS master plan prioritized projects. The replacement of the APS experiment hall roof, as part of a campus-wide Argonne roof replacement program, began in July 2019 and was completed in early 2021 (Fig. 21, right).

A cooling tower replacement and upgrade effort has started in earnest with the installation of a redundant cooling tower bank in FY20, the first of three major cooling tower projects. The replacement of the east cooling tower bank will be completed in September 2022 and the west cooling tower bank will follow with its completion in FY23-FY24.

As of this writing, a total of 14 projects have been completed totaling \$8.7 M as of Q4 FY21 with 23 projects either planned or in progress as of July 2021, totaling nearly \$22.5 M and representing a significant investment in the APS by the Laboratory.

Data network upgrades are a focus when looking ahead to APS-U data demands. In the last three years, the AES Information Technology Group (IT) has performed a number of upgrades and fulfilled large support requests including, but not limited to, these initiatives:

- The APS is upgrading its fiber optic complex in preparation for APS-U-era networking needs. Networking to each laboratory/office module (LOM), to which beamline networks are connected, is being upgraded to 4 x 48 strands of single-mode fiber. LOMs 435-438 have been upgraded and LOMs 431-434 will be upgraded by FY21.
- Multiple beamlines had local networks upgraded to provide numerous 10-Gbps host connections and 2 x 40-Gbps active redundant uplinks to the core switch. For new and upgraded beamlines, additional network switches were added to hutches to provide improved data separation and a more efficient network topology.
- The IT Group supports 34 DM virtual servers (VMs) for XSD and continues working with the XSD Scientific Software & Data Management Group deploying DM VMs for CAT sectors. These VMs coordinate moving data from beamline stations to the Voyager high-performance file system.
- With the onset of the COVID-19 pandemic, IT Group resources were re-deployed to focus on XSD beamline remote access conversion, including domain account access, user account configuration, experimental safety assessment form programming, and set-up of the beamline

portal. Since implementing this service in June 2020, the IT Group now supports 1088 unique users and 162 systems utilizing beamline remote access.

- The IT Group has created a new Beamline Remote Access Status web page to provide beamline staff and scientific users the ability to monitor real-time status of servers and beamline workstations. This service is available at <https://nxstatus.xray.aps.anl.gov/nxstatus/>.

Additionally, the IT Group continues to outsource commodity services to either the Business Infrastructure Services (BIS) Directorate at Argonne or to vendor cloud services as noted below:

- Argonne Guest House networking (wired and wireless)
- Building 402 Auditorium and conference rooms (wired and wireless)
- APS Equipment Tracking System database to BIS Integrated Host Warehouse
- APS Google Appliance to BIS-managed Coveo Cloud Service
- APS DSX on Citrix to BIS Dashplus Citrix server
- BIS DCIM Sunbird for APS datacenter
- Code42 on-premises servers to Fedramp Moderate Code42 GovCloud
- Drupal on-premises servers to Acquia Cloud Services

Direct and immediate improvements were made for beamline data storage and transfer by the IT Group as well, as summarized below:

- 4 petabytes of Data Direct Networks storage installed on Voyager Data Transfer Nodes
 - Used by XSD and CAT beamlines for external data transfer via Globus Online and Secure FTP
- Beamline NetApps storage servers operating in high-availability (HA) configuration
 - 1 PB of high-availability storage is available for beamline operations
 - Converting beamline back-up storage to NetApp appliances
- Implemented Science DMZ with assistance from ESnet network engineers
 - Provides fast, low-latency networking for moving datasets to and from NERSC for data analysis
- Improved direct network connection from XSD beamlines to Building 240 ALCF computing
 - Bypass internal routers and firewalls to speed data transfer
 - Network upgraded to 2 x 100 Gb/s
- Sector 16 (HPCAT-XSD) isolation-mode experiments successfully configured and tested with beamline staff on stations BM-B, BM-D, ID-B, and ID-D

Safety-certified programmable logic controllers (PLCs) have been installed in the next generation of safety systems by the Safety Interlocks Group (SI) for improved safety, additional redundancy, and increased reliability. Safety-certified PLCs were successfully installed and validated in the access control interlock system upgrade prototype in Building 413 as well as in the GEN4 PSS prototype installed and validated at the 28-ID beamline.

Front-end equipment protection system upgrades (which started in the August/September 2018 shutdown period) for insertion device beamlines are approximately 79% complete prior to the August/September 2021 shutdown and will be completed by the December 2021/January 2022 shutdown period, well ahead of the APS-U downtime start in April 2023. These upgrades include moving to an Allen-Bradley ControlLogix programmable logic controller platform for enhanced capabilities and diagnostics. All bending magnet front-end protection system upgrades were completed by the end of the August/September 2019 shutdown.

The SI Group also continues to modernize and standardize the Beamline Equipment Protection System installations to a group standard in replacing legacy beamline installation. As of August 2021, 31 of 57

systems have been converted to the SI Group standard, at a rate of conversion of 1-2 Beamline Equipment Protection Systems per shutdown period.

State-of-the-art technical component design and rendering tools continue to be implemented at the APS. The AES Design and Drafting Group now utilizes advanced 3-D model builds, including a low-memory-consumption system build heavily utilized by the APS-U, referred to as a light skeleton interface model. This group maintains a handheld, reverse-engineering scanner that has seen widespread use for APS Operations facility and beamline applications as well as for the APS-U.

The demand from the facility and operations for 3-D printed components has increased dramatically in the last four years. In 2017, a total of 786 piece-parts were produced, increasing to 1393 in 2018, 2972 in 2019, 2813 in COVID-impacted 2020, and 1658 parts through July 2021, all printed on five machines maintained by the group. A vision of a small production cell was realized in FY20, dedicating laboratory space to house all 3-D printers (plastic- and metal-capable) as well as a small waterjet cutting machine to drastically reduce conventional supply chain durations.

The AES Mechanical Engineering and Design Group continues to provide an overwhelming majority of its group resources (nearly 80%) in direct support of the APS-U. With resources remaining in APS Operations, the group continues to advance the state of the art in design of novel sample holders with the acoustic levitation on 2- and 3-axis sample holder a Laboratory Directed Research and Development project; and through a Small Business Innovation Research project, development of an advanced COMSOL multi-physics simulation predictive capability for next-generation synchrotron light source compact vacuum chambers. There is considerable direct support for design activity required by ASD.

5.4. Mission Readiness – the PSC Operations Portfolio

The PSC Directorate started a Portfolio Management Office (PMO) in 2016 to develop and maintain a portfolio of mission-readiness projects to further execution of the PSC Strategic Plan. The PMO is responsible for supporting the directorate in the execution of an integrated multi-year project execution plan that includes the scope, schedule, effort, and cost for Operations projects requiring more than 300 hours/year effort or \$50K/year for materials and services, or that span multiple years and have complex interfaces where additional management coordination is beneficial to completion of the project.

The PSC Operations Portfolio aligns with the memorandum of understanding between PSC Operations and the APS-U, which lists the agreed-upon responsibilities, activities, and interfaces between the two parties. Broadly, PSC Operations is responsible for maintaining and incrementally improving all existing APS systems in a manner consistent with current operating levels, while the APS-U is responsible for upgrading any systems that will be required to perform at levels beyond those currently achieved.

The PMO is in a continuous process of assessing gaps between the current state of the facility and the envisioned future state, identifying risks and opportunities, aligning the projects with the PSC strategic goals, and determining the order of execution. While the Operations Portfolio projects are outside of the APS-U Project scope, the multi-year execution plan takes into consideration APS-U installation and commissioning schedule and effort needs.

The Operations Portfolio is organized into three programs:

1. Integration: APS Operations projects that benefit from coordinated execution with the APS-U, therefore bringing the facility as a whole to an improved state of readiness when the APS-U is completed and the facility is being restarted.
2. APS Operations: Projects supporting the continued beam delivery for the APS user program. These typically are maintenance and obsolescence issues associated with current systems at the APS.

3. Strategic: Projects supporting the PSC long-term strategy for continued scientific excellence both now and in the future.

The Operations Portfolio resides in an enterprise project portfolio management suite on the ServiceNow platform maintained by Argonne. The web-accessible database increases the portfolio visibility and allows a more agile approach to long-term planning and scheduling as urgent issues arise or priorities change. Proposals may be submitted by individuals, group leaders, or division directors and the PMO takes care to (1) assign proposals to the correct area in the Operations Work Breakdown Structure and (2) evaluate proposals across divisions and groups to identify related projects/proposals that fall into different Work Breakdown Structure areas.

At the time of writing, the portfolio includes 37 active projects, with an approved budget of \$21.3 M. There are six integration projects, 25 APS Operations projects, and six strategic projects currently in the portfolio. In addition, there are another 16 developed proposals, which may or may not be approved for execution as priorities change and budgets are more fully understood. Figure 22 shows the schedule for the integration projects in the portfolio relative to the APS-U installation period.

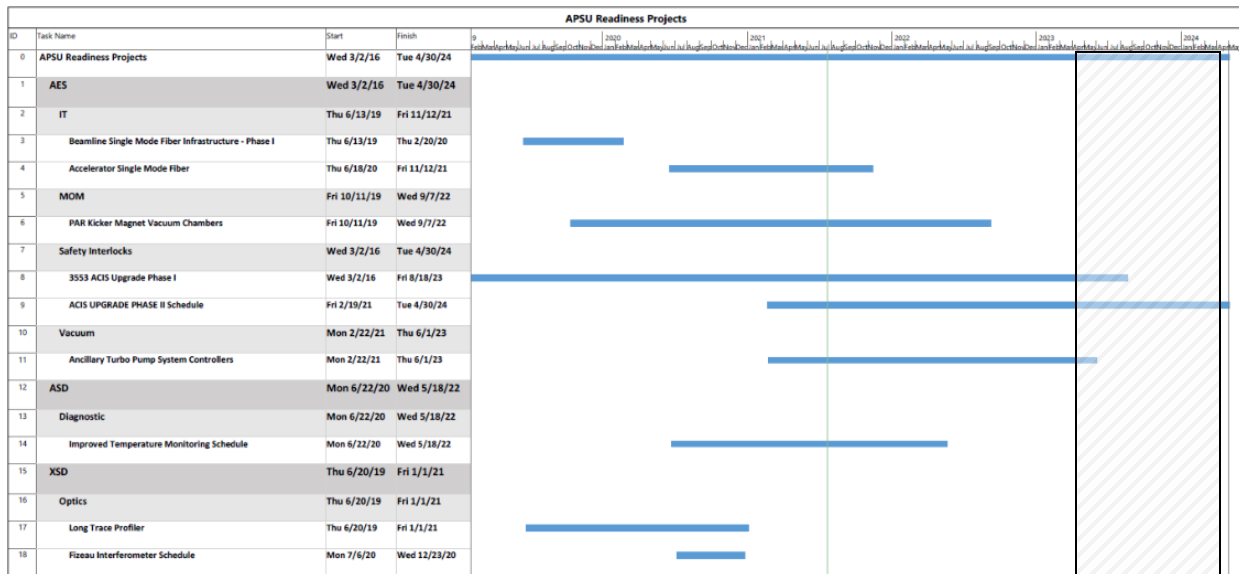

Fig. 22. Projects directly related to the successful integration of the APS Upgrade into the APS facility. The shaded area at the right is the current APS shutdown window for the installation of the APS-U.

5.4.1. FY21 Project Execution Plan

Major FY22 activities include developing resource-loaded plans to:

- install a first-article, 200-kW, solid-state amplifier unit for the storage ring;
- install a first 50-MW klystron, modulator, and digital low-level controls for the linac;
- implement the access control interlock system upgrade;
- upgrade water systems in the linac/particle accumulator ring/booster/storage ring; and
- upgrade the IT network in the injector and beamline areas.

5.5. User Processes and Scientific Access

The APS supports the largest user community of all the DOE light source facilities, as noted in the Introduction to this document. The APS user program includes an integrated, comprehensive suite of outreach, administrative, support, and educational activities to promote user access to the facility and to

fill the future R&D pipeline with both users and scientific staff. Below are highlights of the user program and delineated improvements planned in the coming years that will further enhance support and services to APS users.

A crucial aspect of APS planning is educating the user community about the APS-U installation period. Installation is now scheduled to begin April 17, 2023. The delay of 10 months is the result of the COVID-19 pandemic and associated impacts to the project. Delaying the shutdown period allows the APS to continue operating for all three runs in 2022. There will also be an Operations run early in 2023, with the exact schedule to be determined.

A major focus in FY22 will be to effectively and transparently communicate with the user community and the CATs to provide information about the APS-U installation period and to solicit ideas from the community about how to minimize the significant disruption to scientific access that the installation period represents. The BES light sources have documented complex-wide beamline capabilities that will be available going into and throughout the APS-U installation period in order to provide APS users with clear options for alternate beamlines that will be available while the APS is offline.

5.5.1. Outreach to Users

The APS fosters and promotes scientific communication and collaboration through the organization and support of a diverse array of conferences, workshops, schools, and short courses as well as hands-on training opportunities encompassing the use of x-ray techniques, software, and data collection systems designed to familiarize APS users with the ever-evolving technology and research foci at the APS. These activities also serve to expand the user base.

As the APS Upgrade Project moves ahead, clear and focused communication is required to keep APS users apprised of activities and informed about the new science opportunities. A variety of technical offerings to inform about the technical parameters of the APS-U have been provided to assist users, APS staff, and resident beamline staff in best aligning their upgrade-related plans, thus maximizing the benefits they will derive from the improved source.

A variety of conferences, schools, and workshops offered in fiscal year 2021 are listed below:

- X-ray Powder Diffraction and Pair Distribution Function Data Analysis Course (November 2 - November 5, 2020)
- Bright Future for *In Situ* and *Operando* Structural Science at APS (-U) Workshop (January 11-15, 2021)
- Capabilities and Opportunities at the APS Coherent High-Energy X-ray (CHEX) Sector (April 30, 2021)
- APS/CNM Users Meeting (May 3-14, 2021)
- CHEX Workshops:
 - CHEX Workshop on PLD / HAXPES / Sputtering (May 28, 2021)
 - CHEX Workshop on MOCVD / ALD / Catalysts / SIC (June 4, 2021)
 - CHEX Workshop on Electrochemistry / Geochemistry / Energy Storage (June 11, 2021)
 - CHEX Workshop on Bulk Synthesis (June 18, 2021)
 - CHEX Workshop on Applied Materials and Manufacturing Science (June 25, 2021)
- 23rd National School on Neutron and X-ray Scattering (July 12-30, 2021)
- Workshop on meV-Resolved Inelastic X-Ray Scattering (September 6-9, 2021)

Two online APS Upgrade Q&A sessions hosted by leaders of the APS and the APS Upgrade Project were held in FY21 for the purpose of answering questions about the project's scope and timing, and the science the upgraded APS will enable. The first was held during the virtual APS/CNM Users Meeting and garnered nearly 200 participants. The second session featured an advance call for questions and was

focused on XSD and CAT operations staff. A document summarizing the answers to all the questions addressed during these events has been posted online (<https://www.aps.anl.gov/APS-Upgrade/FAQ>).

Input from these activities and from other mechanisms is being utilized to align the selection of upgraded beamlines and accelerator source parameters with user needs and the most transformative science opportunities. In addition, outreach to CAT funding agencies and organizations helps the CATs sustain their operations and implement capital improvements to their facilities.

The User Program Office also continues to support and promote interest in user research conducted at America's national user facilities via professional communities and research networks, and by highlighting awareness about the benefits and significance of user facility research. The pandemic continues to generate expanded opportunities for communications at various levels with the resident beamline staff and users: the new APS mobile app, e-mail announcements via MailChimp, the interactive tool Ask the APS User Organization, the Beamline Info Broadcast (an internal communication tool for APS and CAT beamline staff), and the APS/User News MailChimp newsletter.

5.5.2. User Support/Access

The APS provides both administrative and scientific-access support for users. User-related systems are being continually being improved, expanded, streamlined, and integrated in order to provide better service for users, better data collection for future planning, and to enhance cost savings.

The User Program Office continues its ongoing review of all user-focused online systems, including registration, proposals, scheduling, user portal, and experiment safety as well as all related user communications in an effort to streamline and better integrate all of these systems. An update on this effort and other accomplishments completed in 2021 is below:

- Organized the first-ever fully virtual annual APS/CNM Users Meeting held May 3-14, 2021, which garnered more than 1100 registrants.
- As part of the Argonne Improving How We Work (IHWW) User Experience team, completed integration between the APS user registration form and the Argonne Foreign Assignment/Visit Request (FAVOR) system to capture resumés and U.S. customs and immigration documents from user registrations ensuring that all personal identifying information is collected and maintained by the Argonne Business and Information Services Directorate. This eliminated all manual processes previously required to collect such documents.
- Automated the generation of Foreign Visits and Assignment host addendums when each APS experiment is completed by integrating the APS safety form system with the ANL FAVOR system. This was previously done manually.
- Implemented an integrated ORCID collection and authentication process within the APS/CNM registration process.
- Successfully completed the effort to secure Service Now licensing and a service provider for the universal proposal system project with the LCLS, the National Synchrotron Light Source-II, and the APS.
- The User Program Office is championing a new Argonne IHWW initiative entitled the Argonne Enterprise Registration System, which will be a comprehensive, centralized registration system that will collect and process data for multiple types of people coming to the Laboratory and that will integrate with the current Argonne applications (e.g., human resources, security, training, badging, etc.). Potential vendors are being evaluated.
- User Program Office staff are participating in a multi-team review of the General User Program at the APS.

- Three User Program Office staff are members of the PSC DEI initiative. Staff contributions include development and maintenance of the DEI web site and production of DEI newsletters for PSC.
- A number of new platforms and procedural changes were required due to the pandemic. Among them are:
 - Implementation of a custom APS mobile phone app for users.
 - Development of on-line forms to request floor coordinator assistance and to report completion of an experiment. Both of these forms are also available via the APS mobile phone app.
 - Development and management of an online request process for on-site access to ensure requests meet current site access requirements during COVID restrictions.
 - Added links to facilitate user remote access and data management for XSD beamlines into My APS Portal.
- All FY21 beamline reviews, SAC meetings, and joint APS User Organization/Partner User Council committee meetings were held virtually due to the pandemic.

Goals for FY22 include:

- continuing efforts on the Argonne Enterprise Registration System project—work on a new registration system should begin in 2021;
- continued efforts on the Universal Proposal process—work on a new proposal system for the APS should begin in 2021;
- eliminating the necessity to mirror Argonne’s training system on APS servers as part of the IHWW team project;
- continuing integration of ORCID into APS systems (e.g., upload service awards to user ORCID records, identify beamlines, techniques, and proposals with ORCIDs); and
- ongoing planning for the APS General User Program post-dark time.

5.5.3. User Training

Most required user training is now available on the web and can be taken by users online, saving time and enhancing the safety profile of the community. Individual user training expiration dates are included in both the My APS Portal and the Experimental Safety Assessment Form to ensure that users participating in any work (whether in-person or remote) are up to date with all required training before an experiment begins. The IHWW team will complete the project under way that will eliminate the need for the APS to “mirror” the Argonne user training courses and enable the APS to directly utilize the Argonne training management system.

5.5.4. Proposal Review Process

Upon determination of a chosen proposal platform by the BES light source directors, the APS User Program Office will initiate procurement and work with the vendor to begin development of a new proposal system.

5.5.5. Training the Future Science Generation

Staff of the APS are dedicated to being strong and active advocates for training graduate students to more effectively and efficiently use U.S. national x-ray facilities. The APS is continually striving to expand its networking and education programs. In FY20, almost 39% of the experiments at the APS involved participation by undergraduate or graduate students who were generally part of a larger, university-based research team led by an experienced researcher. This hands-on experience helped students learn to formulate new scientific ideas, prepare successful research proposals, plan and conduct experiments, and

analyze and interpret data. Postdoctoral scholars, often as principal investigators, participate in 20% of the experiments performed at the APS.

The flagship school is the National School on Neutron and X-ray Scattering. For more than two decades, the APS has co-hosted the school (originally with the former Intense Pulsed Neutron Source at Argonne, now in partnership with the Spallation Neutron Source at Oak Ridge National Laboratory). This program has educated well over 1000 graduate students; some of these former students are now sending their own students to this summer program. School organizers are expanding the curriculum to train potential users of the next generation of high-brightness sources, such as the APS-U. Due to the ongoing COVID-19 pandemic, in FY21 the school was held virtually with students participating in experiments remotely.

The APS staff and resident beamline staff at the CAT sectors continue to participate in the growing Argonne Exemplary Student Research Program for high school students organized by the Argonne Educational Programs and Outreach Division. Fiscal year 2021 was the tenth anniversary year of the program. Teams of students work closely with APS and CAT beamline staff to learn about careers in x-ray science and conduct experiments. The APS is always seeking ways to expand this program by leveraging beamlines that have outreach components in their funding profiles.

5.6. Human Capital and Workforce Development

The most important resource of the PSC Directorate is its people; they are the essence of a very dynamic organizational culture. The PSC Directorate, which comprises the three APS operating divisions (ASD, AES, and XSD) and the APS Upgrade Project, prides itself on a workforce that includes a diverse collection of outstanding scientists, professionals, and support personnel dedicated to scientific discovery and to finding solutions to intractable problems of national and international importance. Attracting and retaining a world-class community of talent is essential to maintaining the PSC Directorate reputation and record of performance.

Identifying, implementing, and integrating workforce strategies throughout the directorate is a high-priority issue for the PSC leadership. To be successful, the PSC must contend with the many variables that affect the organization's ability to successfully attain its strategic objectives and achieve its mission outcomes. In order to realize this, the PSC Directorate is strongly committed to talent management approaches that efficiently and effectively attract, engage, and retain human capital.

To be effective, the PSC Directorate focuses on five key areas:

- Workforce planning
- Organizational capability assessment
- Professional development, career advancement, and succession planning
- Diversity, equity, and inclusion
- Change management

In addition to professional development via traditional enrichment paths such as technical conference attendance and participation, the Argonne Leadership Institute and the Employee Resource Groups (ERGs) at Argonne further personal and professional development, promote diversity within Argonne, and strengthen networking opportunities within the community. Argonne is committed to a diverse and inclusive environment that celebrates the uniqueness of every individual.

The PSC Directorate established a dedicated Diversity, Equity & Inclusion Council to be an advocate for the diverse PSC community and partner with leadership to seek out improvements by promoting Argonne core values and DEI initiatives. The PSC Directorate is committed to the highest standards in recruiting, hiring, mentoring, recognizing, rewarding, and providing professional advancement opportunities for all staff members.

The PSC Directorate is strongly committed to a talent management strategy for attaining strategic objectives and achieving mission outcomes. To have an effective talent management strategy, the PSC Directorate will focus on the following talent management areas over the next five years, with yearly reviews.

The PSC Directorate maintained operations well during the global COVID-19 pandemic. As required by the DOE and Argonne, PSC staff, along with the rest of the Laboratory, transitioned to a largely telecommuting minimum safe operations mode. Following federal, state, and local guidelines, the Lab is at the time of writing operating under less-restrictive limited operations. In preparation for fully lifted restrictions, a remote working strategy has been developed. It involves a complete evaluation of which roles could be effectively performed fully, partially, or rarely onsite while considering the use and support of onsite equipment and labs as well as the ability to meet client, collaborator, and sponsor expectations.

PSC Human Resources in partnership with Argonne Human Resources Services maintained the ability to meet the PSC hiring needs and carry out all day-to-day human resources functions and responsibilities while operating primarily offsite. The pace of recruitment and on-boarding of new hires, particularly for the APS-U, continued almost without interruption. As a result, in the period from October 1, 2019, through September 30, 2020, PSC Human Resources virtually on-boarded a total of 50 new regular, term, and union employees.

5.6.1. Workforce Planning

A process is in place to review divisional workforce plans routinely throughout the year. This allows PSC management to identify staffing requirements before they become challenges. The PSC directorate is committed to an annual, comprehensive review of talent capability for both accelerator and beamline operations by using APS and APS-U staffing prerequisites. With this kind of insight, the PSC line managers can direct recruitment, employee development, and retention and recognition resources accordingly in real time, as issues and needs arise.

5.6.2. Organization Capability Assessment (Talent Discussions)

The PSC Directorate is compelled to better understand its organizational capability, collective skills, expertise, and alignment of people resources. To achieve this, management conducts talent discussions once a year that:

- provide the directorate executive team with an opportunity to build a shared model of the strengths and weaknesses of its people resources,
- allow the directorate executive team to prioritize performance improvements from her or his respective areas, and
- provide an opportunity for the directorate executive team to shape and convey to staff the directorate performance goals and expectations for each person.

5.6.3. Professional Development and Career Advancement

The PSC Directorate is committed to the professional development of staff members' knowledge, skills, and abilities required for career advancement. This includes all types of facilitated learning opportunities, ranging from formal coursework to specific conferences and informal learning opportunities. The PSC Directorate uses a variety of approaches to professional development, including coaching, consultation, communities of practice, mentoring, lesson study, reflective supervision, and technical learning.

Frequent and open communication with employees reveals those personal and career development goals that align with the directorate's strategic goals. Finding the commonalities means finding a mutual goal and a supportive relationship between directorate and employee for achieving it. Like all PSC functions,

this critical initiative has continued remotely even in the face of obstacles imposed by the COVID-19 pandemic.

5.6.4. Core Values

As the APS continues to expand into new scientific frontiers, Argonne’s core values guide the PSC Directorate in maintaining a safe and inclusive environment in which PSC employees and partners can thrive.

Impact: We think creatively, pursue innovative ideas, and deliver excellence to positively change our community, nation, and world.

Safety: We take personal responsibility for the safety, security, and well-being of ourselves, those around us, and our environment. The COVID-19 pandemic has broadened the scope of this critical core value to include multi-level, reinforced guidance for best practices to guard against coronavirus infection/transmission.

Respect: We embrace diversity, value the perspectives and contributions of others, and act professionally toward all.

Integrity: We are honest, keep our commitments, and take responsibility for our actions and outcomes.

Teamwork: We include and inspire others, share and communicate openly, and celebrate success as one Argonne team.

These values serve as guideposts as the PSC community comes together to create a safe, inclusive, and welcoming environment.

5.6.5. Diversity, Equity, and Inclusion

The PSC Directorate is committed to working with the PSC Diversity, Equity & Inclusion Council; the Argonne Diversity, Equity & Inclusion Office; internal ERGs; and other Argonne resources. The PSC Directorate Diversity, Equity & Inclusion Council identified three strategic priorities based on results from the 2020 Climate Survey:

- Culture and Workplace: Foster and maintain a professional, supportive, and inclusive culture by providing valuable diversity, equity, and inclusion information and initiatives.
- Career and Workforce: Promote professional development, resources, training, and networking opportunities that support career development and growth.
- Community and Partnership: Collaborate with other DEI councils, ERGs, and education programs and outreach to leverage collective works and ensure PSC participates in STEM initiatives for next-generation scientists and researchers.

“Argonne values excellence in science and engineering, and it values the contributions that individuals make. The lab strongly encourages collaboration for the simple reason that scientific innovation is more likely to occur when individuals with diverse viewpoints, approaches, methodologies and backgrounds work together to solve a problem. In this, our collective diversity and an inclusive culture add value to scientific enterprise.” (Source: www.anl.gov/hr/diversity-and-inclusion)

5.6.6. Change Management

The PSC Directorate is committed to a year-over-year:

- alignment of the organizational structure to strategy (Laboratory/directorate/division);

- reduction of complexity of the organizational construct (one important principle kept in mind is not making the roles of the leadership team too confusing or complex);
- focus on better divisional proficiencies;
- identification of those places where organizational complexity is an issue, where complexity caused by factors such as a lack of role clarity or poor processes is a problem, and what is the responsible course of action; and
- weighing the work to be done against the load on line managers and staff.
 - It is often difficult for some managers to focus on leadership tasks because of expected output requirements and competing priorities between departments, and thus is important to balance:
 - a) staff, directly supervised and managed,
 - b) the ability of the staff to do work without any supervision, and
 - c) the amount of work that managers must do to stay on top of their responsibilities.

Change management continues to be important in this environment where varying degrees of hybrid work arrangements are in place and likely to remain both during and after the COVID-19 pandemic. The PSC Directorate, like the rest of Argonne, has been agile in altering the way an enormous array of job responsibilities is carried out in order to meet the requirements of Argonne operations modes.

5.6.7. Summary

The PSC Directorate talent management strategy flows from the directorate mission, vision, values, and goals. The strategy will enable the PSC Directorate to sustain a world-class community of talent and ensure achievement of the Laboratory’s mission.

Within the next decade, the PSC Directorate can expect to see:

- a growing number of retirements from a predominantly mature work force;
- increased competition for highly skilled employees, especially those at early-to mid-career, and a continuing need to balance competing priorities in a fiscally responsible manner; and
- a shift in the work environment where remote and hybrid work locations and desire for more flexible work schedules move to the fore.

The talent management strategy supports both short- and long-term PSC priorities and objectives by fostering employee growth and development, encouraging on-going communication, and promoting diversity and leadership at all levels. This strategy positions diversity, equity, and inclusion at the forefront and sets a direction and vision for managing the PSC people and talent.

6. Summary and Outlook

The APS is moving forward to implement a major upgrade that includes installation of a MBA magnetic lattice into the existing storage ring tunnel to increase x-ray beam brightness and coherent flux 100 to 1000 times. Together with the construction of new beamlines that are optimized for the MBA source, these upgrades will transform the APS into a fourth-generation storage ring that will revolutionize imaging, microscopy, and nanobeam science as well as high-energy x-ray techniques.

Numerous technical components for the APS-U were received, assembled, and tested in 2021, despite the effect of the pandemic. As of the end of July 2021, over 1000 of the 1321 storage ring magnets have been received, all 1255 bipolar power supplies have been received, extrusion of all 105 M1 vacuum chambers was completed, installation of experiment enclosures for 28-ID and 25-ID neared completion, and construction of the Long Beamline Building was well under way.

Following the implementation of the APS-U Project, APS accelerator and beamline performance, user support, and infrastructure systems will remain at a world-class level. Concurrently, the PSC Directorate will continue to develop its human capital, improve the user experience, and train the future generation of users. To fulfill the APS mission, “The Advanced Photon Source Strategic Plan” serves as a baseline guide that captures these goals over the next five years.

Input to “The Advanced Photon Source Strategic Plan” was achieved through many channels, including discussions with DOE sponsors, the APS user community, sister facilities, resident users, APS staff, Argonne leadership, and the broader scientific community. Discussions (both specific to this document and on a broader basis) occurred at regular meetings (e.g., the APS Scientific Advisory Committee, the APS User Organization, the APS Partner User Council), reviews such as DOE reviews of APS Operations and the APS Upgrade Project, and special workshops that considered future plans for the APS and similar facilities.

This plan will be reviewed annually and revised on a rolling basis. Updates as needed will accommodate significant changes in funding, shifts in the priorities of DOE and our user community, or new research avenues and opportunities.

Appendix 1: Beamlines at the APS

ARGONNE NATIONAL LABORATORY 400-AREA FACILITIES

ADVANCED PHOTON SOURCE

(Beamlines, Disciplines, and Source Configuration)

ADVANCED PROTEIN CHARACTERIZATION FACILITY

CENTER FOR NANOSCALE MATERIALS

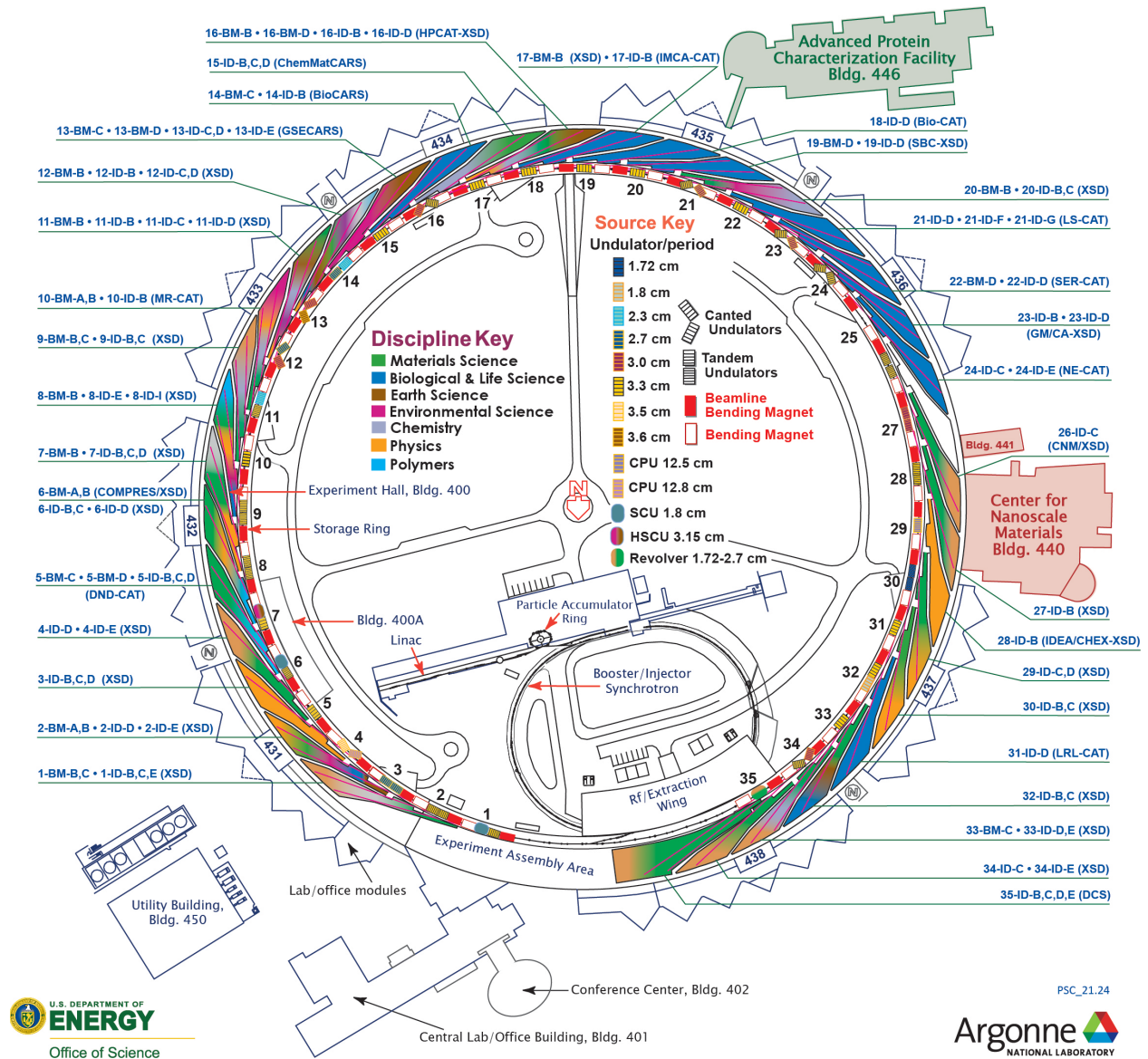

Schematic of APS beamlines, disciplines, and x-ray sources. There are currently (FY21) 67 operating x-ray beamlines; 34 supported by APS operations and 33 of which are operated by the CATs.

Appendix 2: User Data

APS On-site and Remote Users (FY 1998-2021)

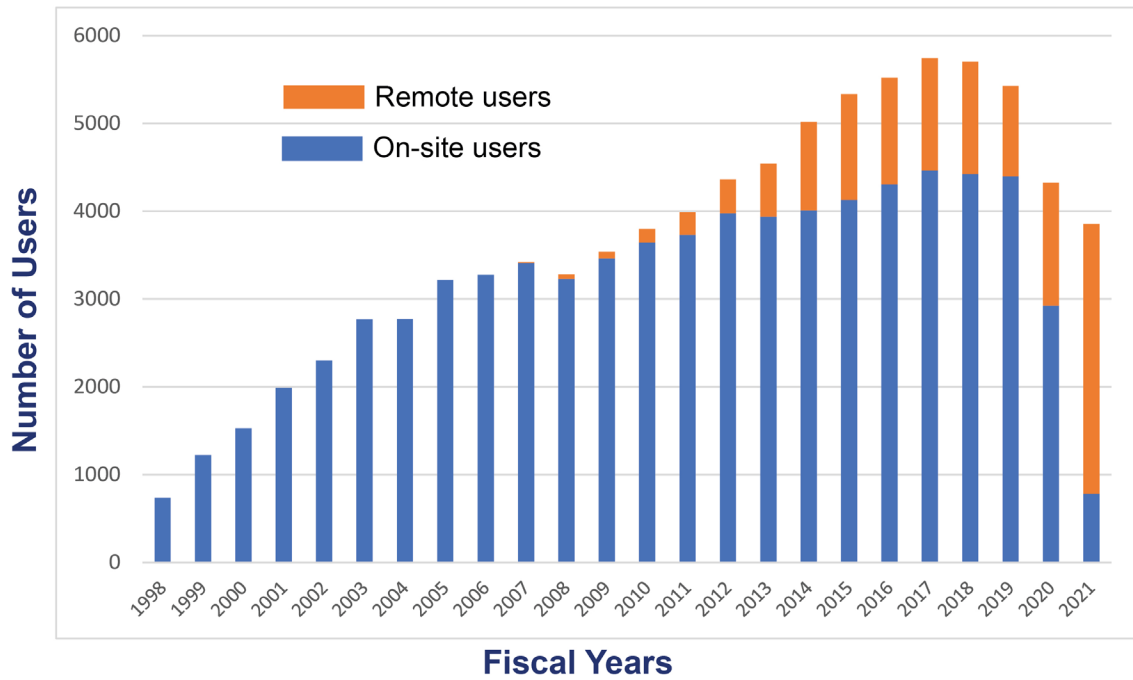

Note: 1). Prior to FY14, mail-in users were not included in the Remote category.
 2). FY20, new BES user counting policy has been applied so that only 1 unique user is associated with mail-in experiments and the user is only counted once in the whole population.

Number of APS Experiments by FY (1998-2021)

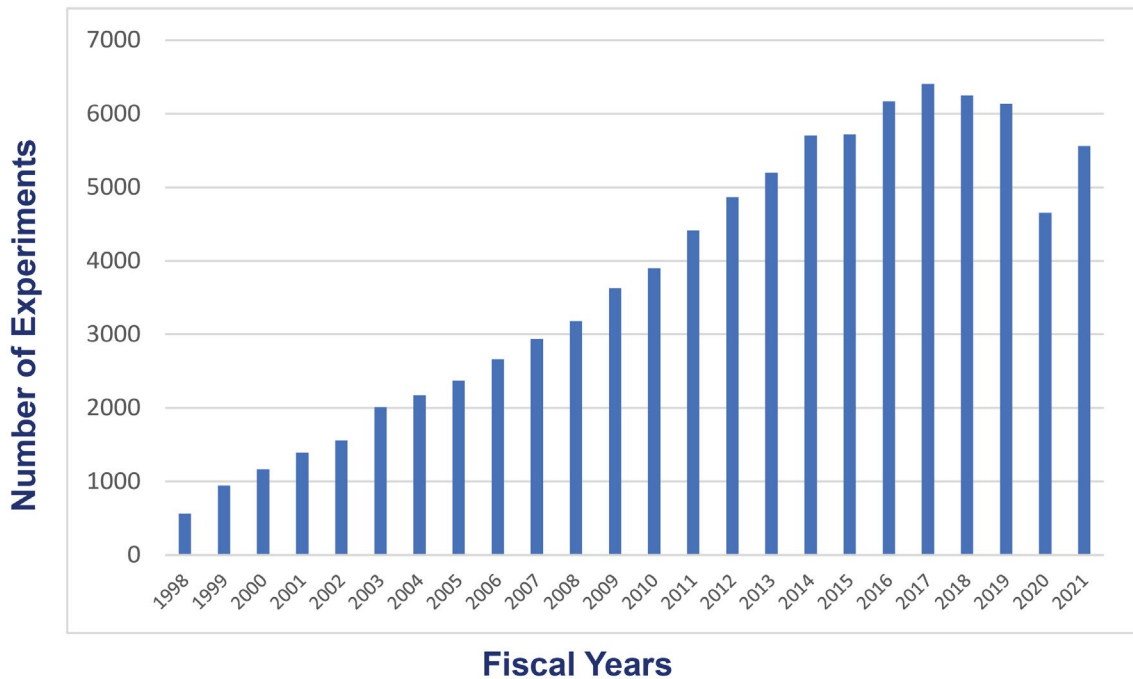

APS Users by Source of Support FY2021

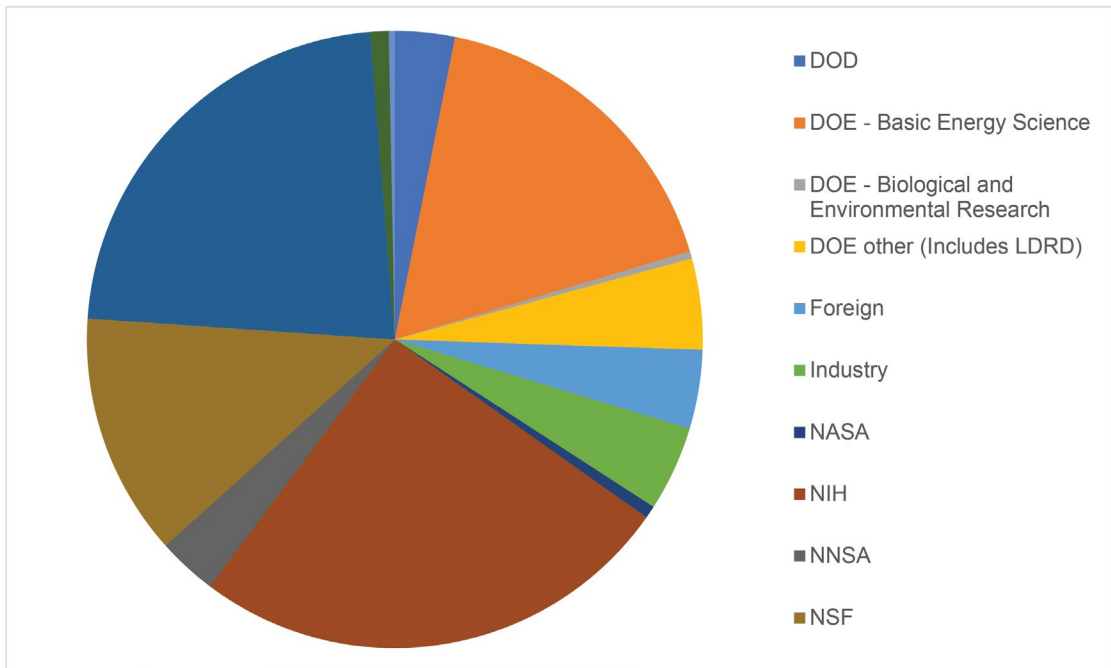

APS Users by Experiment Subject FY2021

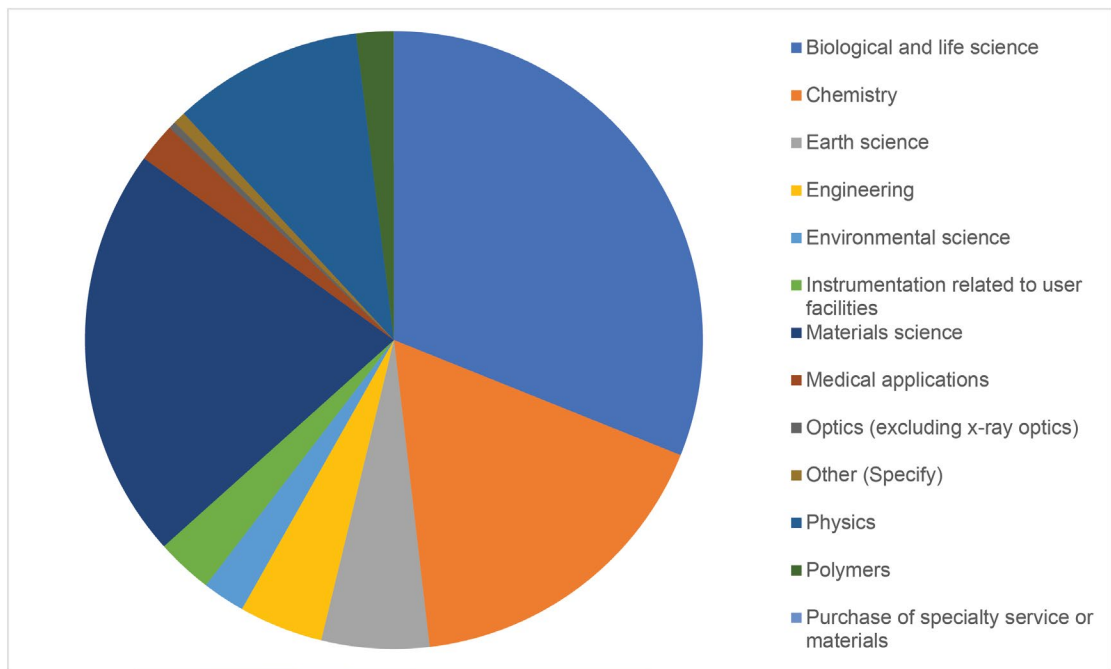

APS User Institutions by Institution Type FY2021

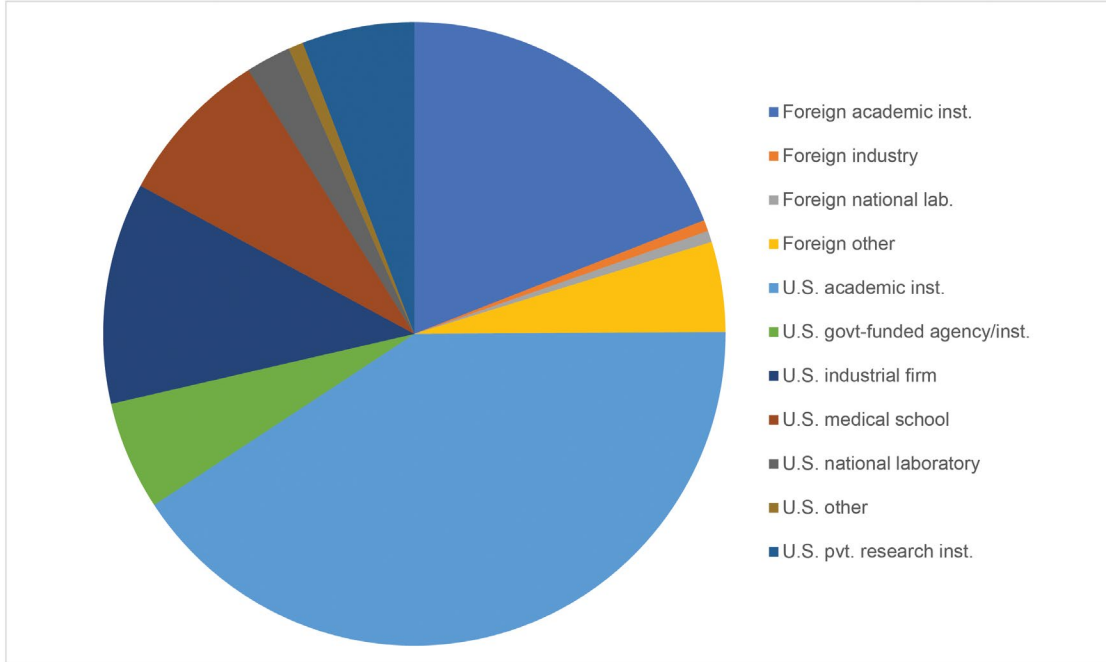

APS Users by Employer FY2021

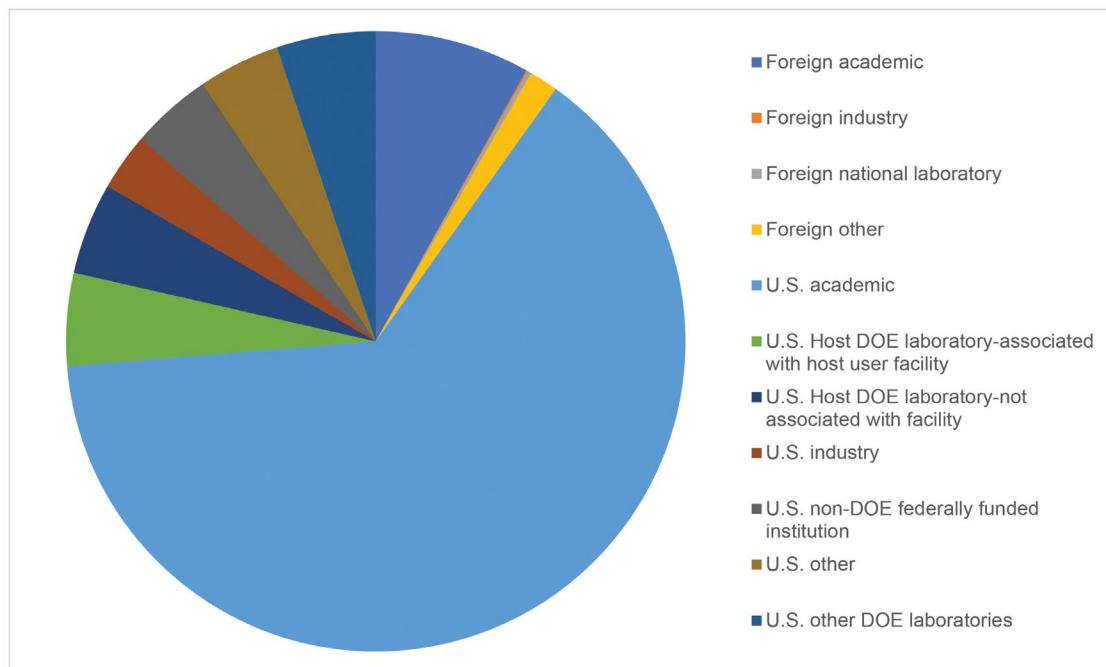

APS Users by Employment Level FY2021

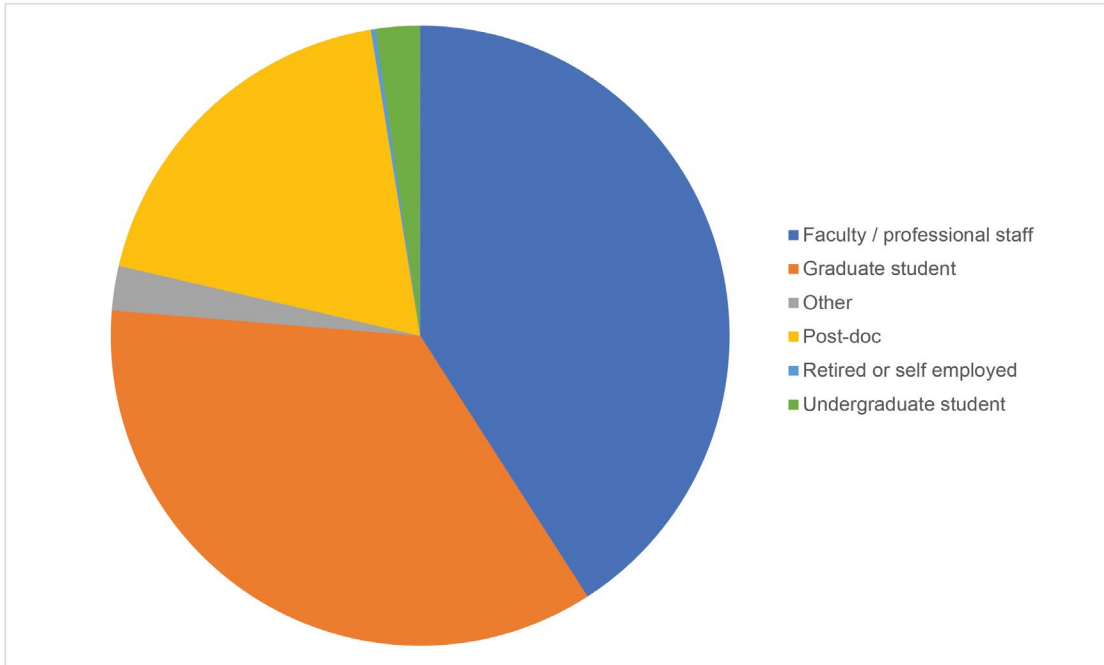

APS Users by User Type FY2021

