

The OPT Crystal Optics Fabrication and R&D Capabilities and Ongoing Efforts to Support APS Operations and APS-U

XianRong Huang

Optics Group, X-ray Science Division
Argonne National Laboratory

Outline

- ❑ **Mission of the Crystal Optics Section in the Optics Group (OPT)**
- ❑ **Equipment & Capabilities**
- ❑ **Regular Operation**
- ❑ **Main R&D projects**
- ❑ **Efforts and Plans for APS-U**



Mission of Crystal Optics Section in OPT

Design/modeling, fabrication, characterization, and development of monochromators, analyzers, and almost all kinds of crystal-based X-ray optics:

- **Operate a wide range of instruments for in-house crystal fabrication:** from orienting to cutting, dicing, grinding, lapping, polishing, etching, characterization.
- **Fabricate the majority of crystal optics used at APS.** Also for other DOE labs.
- **X-ray topography characterization** of crystals in lab and at the Optics Testing Beamline 1-BM.
- **R&D** on design and development of novel X-ray crystal optics and instrumentation.
- **Participate in major optics development projects of APS/APS-U:** sub-10-meV RIXS, meV to sub-meV IXS, high-heat-load DCMs, quartz/sapphire optics, diamond optics, crystal optics for X-ray coherence and imaging, etc.

High-heat-load crystals for commercial DCMs

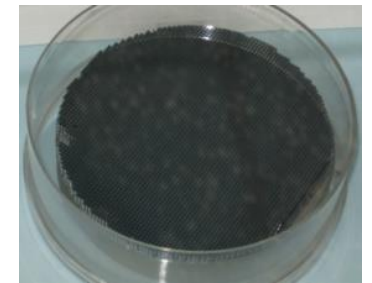
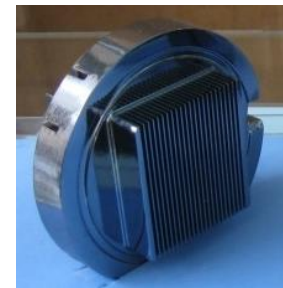
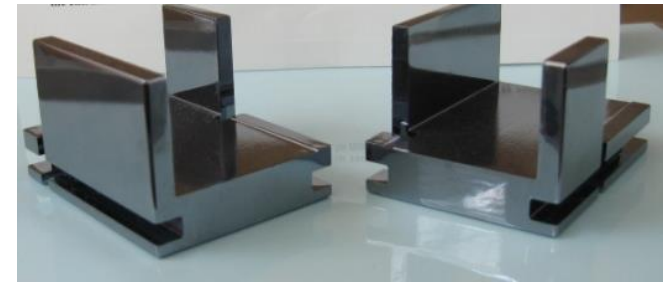

Fabrication: Examples of monos and analyzers fabricated at APS

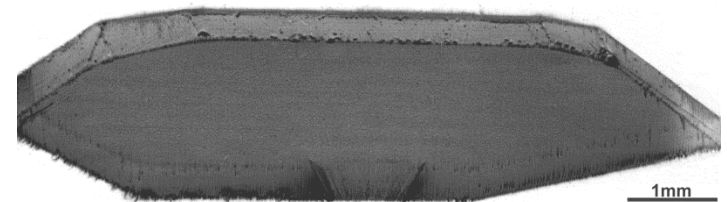

Characterization: X-ray Topography of diamond single crystal

Crystal Optics Staff Members

Led by **Lahsen Assoufid** (OPT Group Leader)

➤ **XianRong Huang, Section leader:**

- Dynamical theory of crystal diffraction
- Crystal optics design, modeling and development
- Crystal orientation
- Topography

➤ **Michael Wieczorek:**

- Fabrication (orienting, cutting, dicing, etching)

➤ **Elina Kasman:**

- Polishing expert
- Development of new techniques, such as automated channel-cut polishing, etc

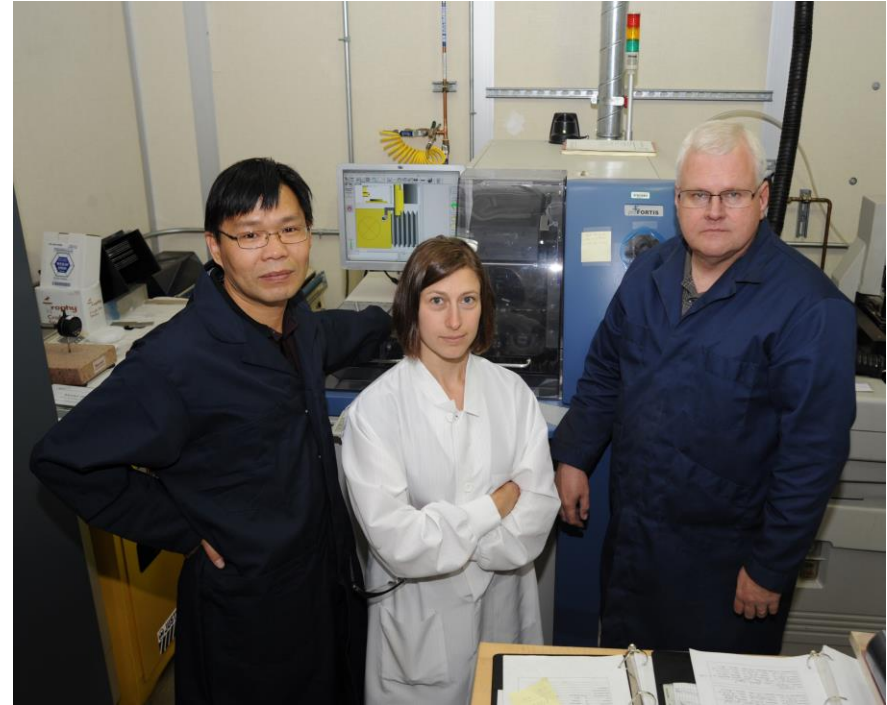

XianRong, Elina, Michael

More examples of crystals fabricated in OPT

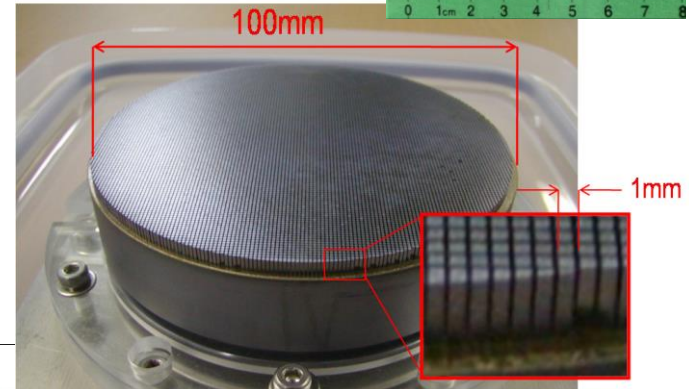
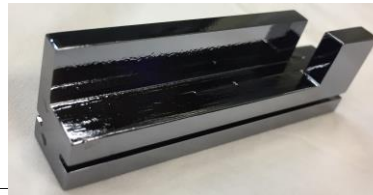
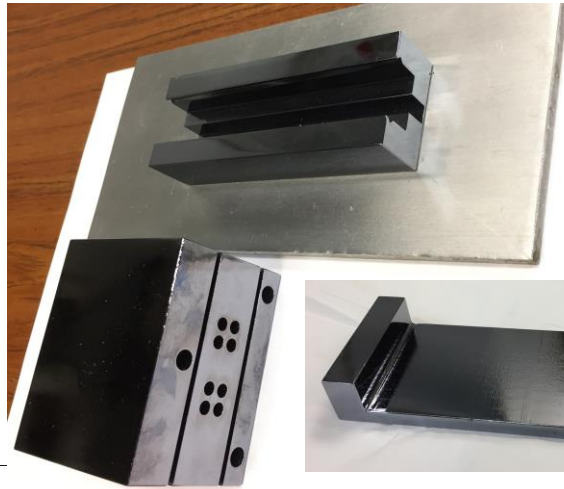
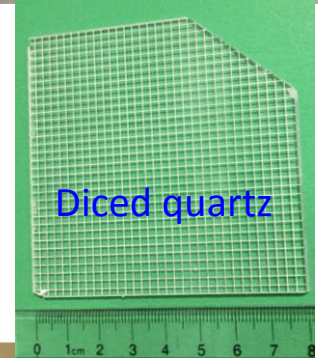
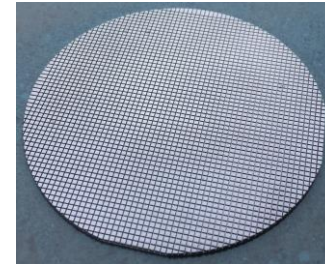
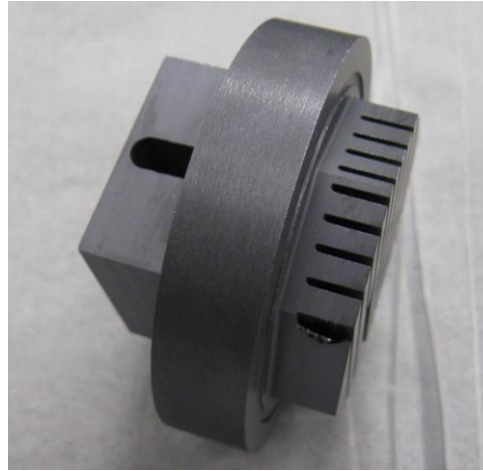
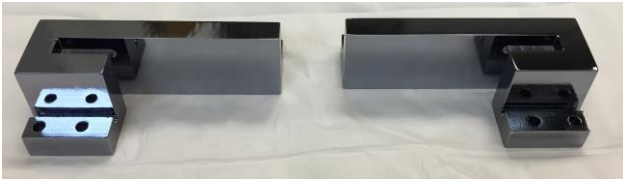
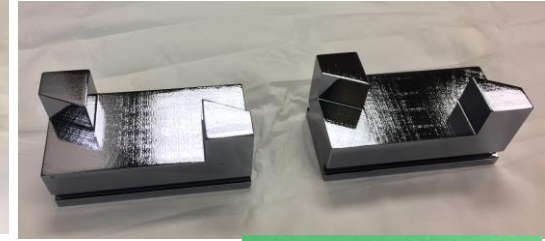
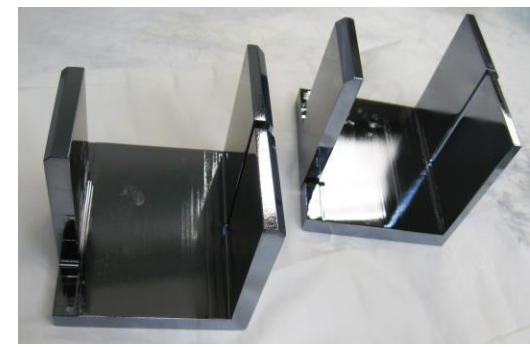
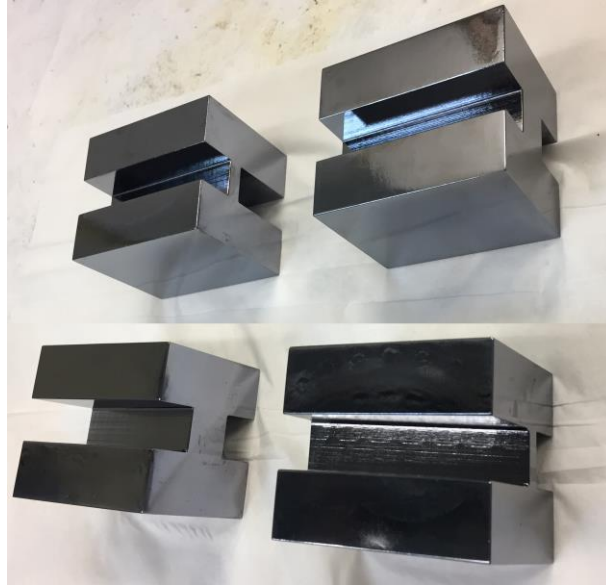

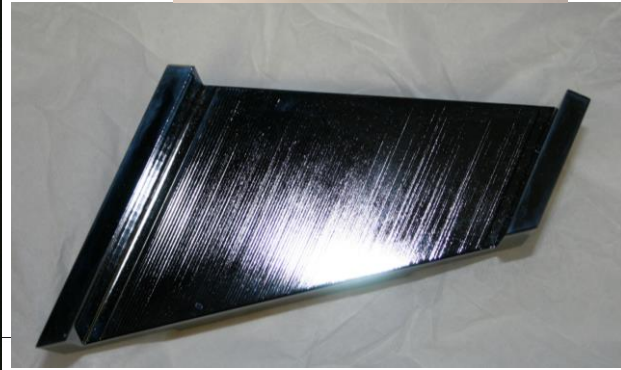
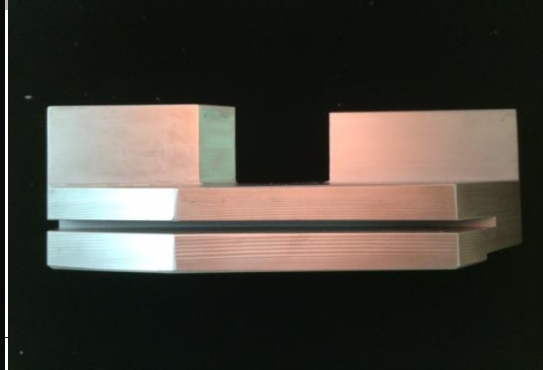
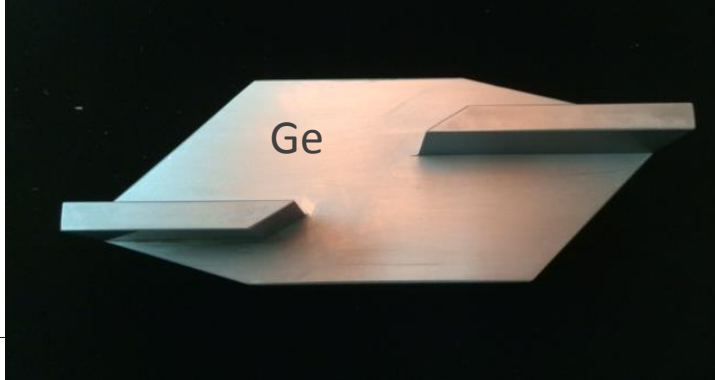
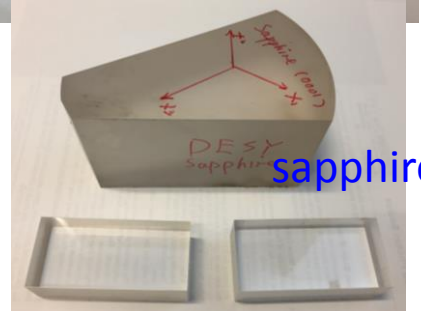
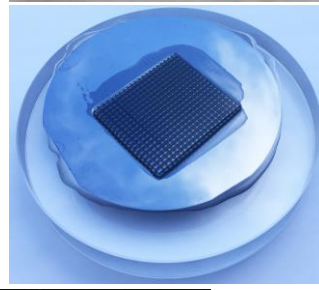
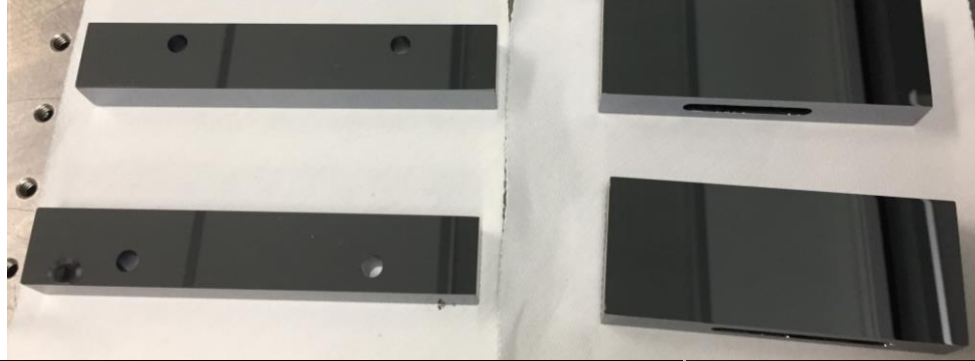
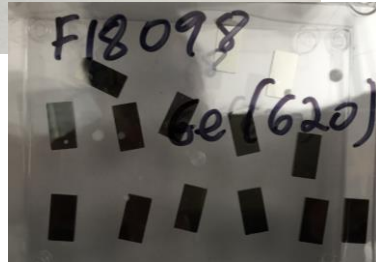
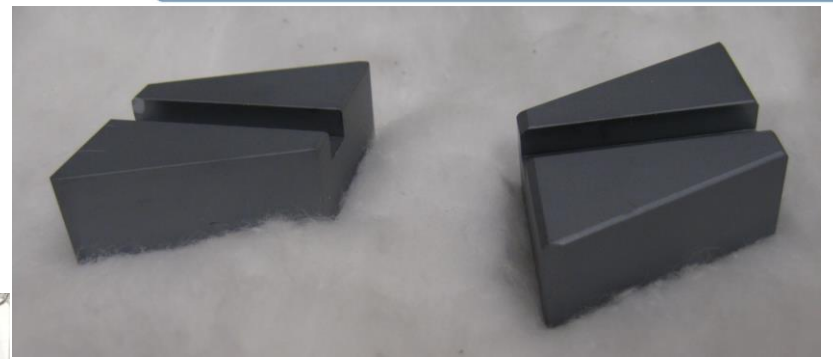
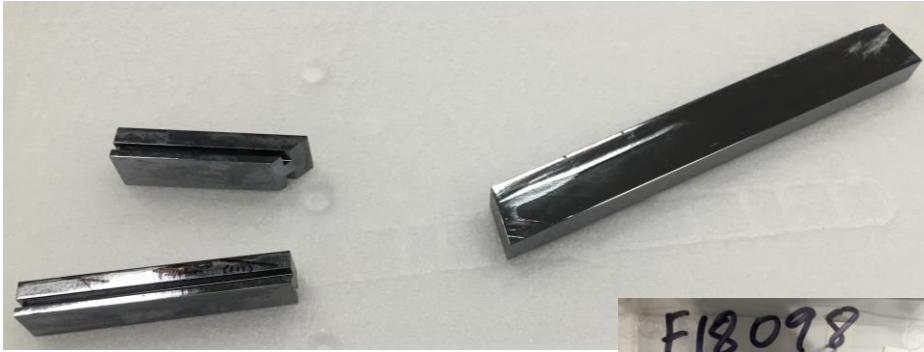

Crystal Optics for Neutron, for ORNL/SNS

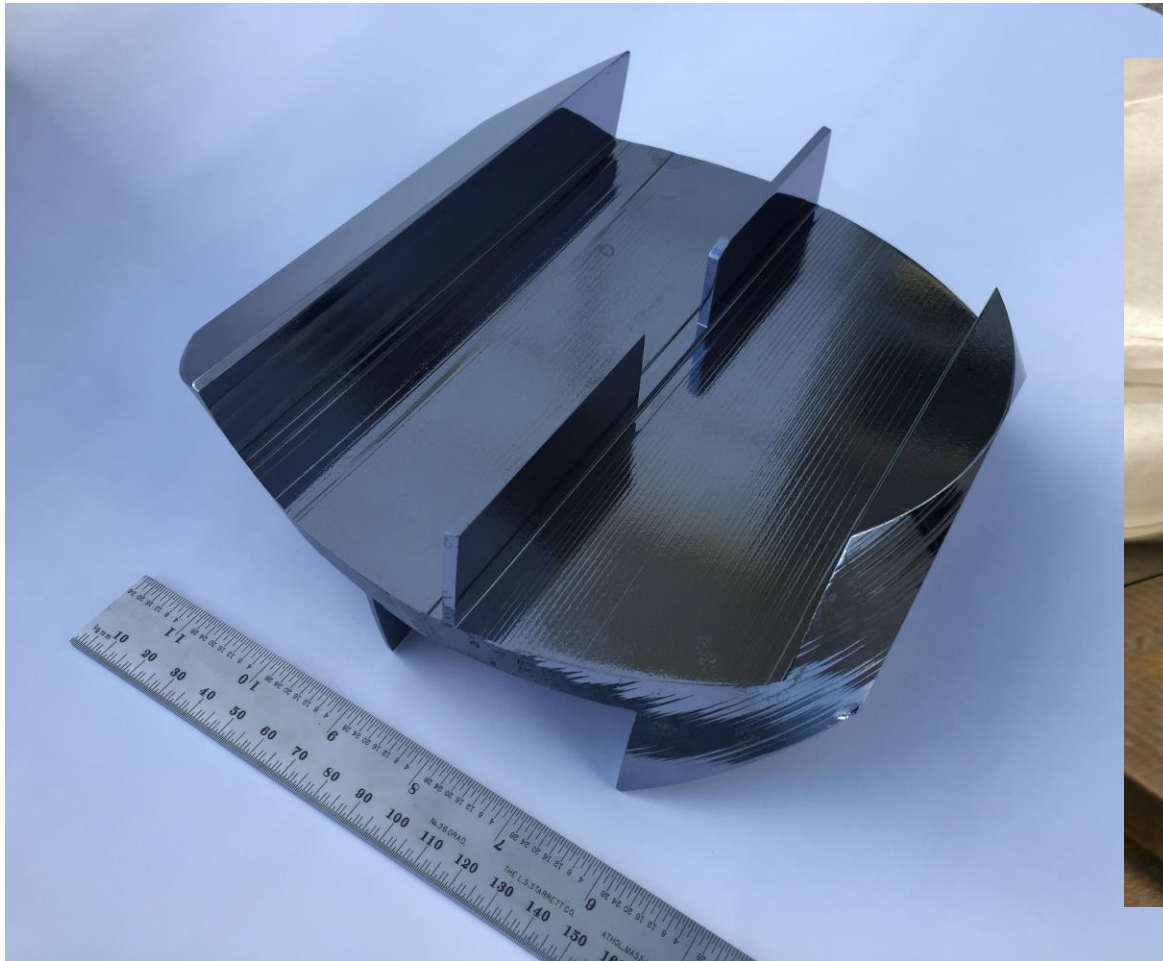

Neutron interferometer

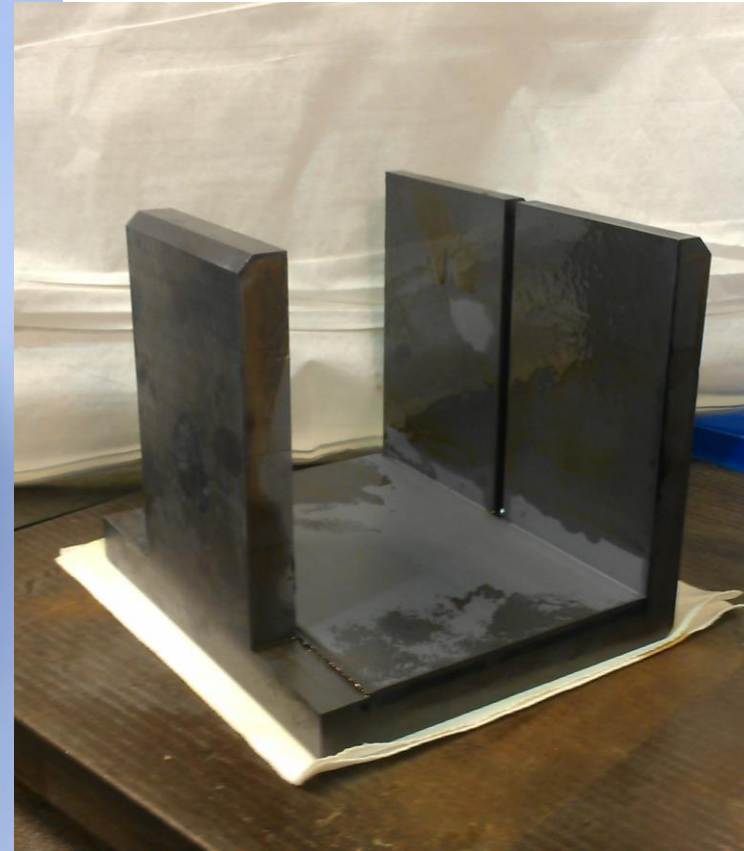

3-bounce
neutron monochromator

Crystal optics equipment and capabilities

Crystal Orienting

- **Two-circle orienter**
orientation precision $\sim 0.1^\circ$,
will upgrade to $\sim 0.02^\circ$

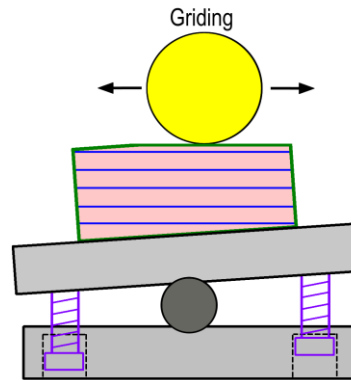
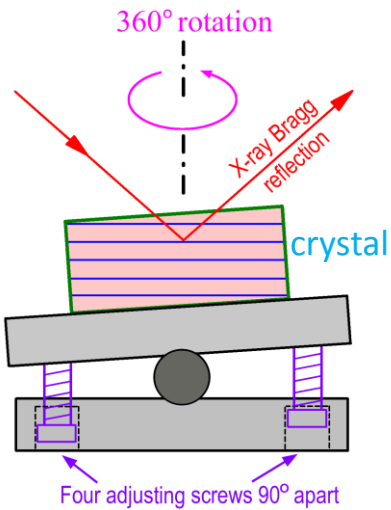

Crystal fixture

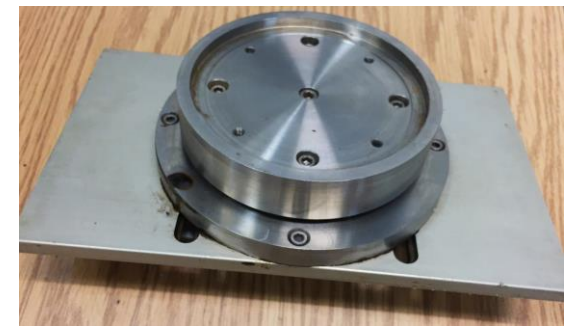

- Back-reflection **Laue camera** for quick determination of crystal orientation (precision $\leq 0.2^\circ$) with home-made LauePt software for any crystals, any orientations

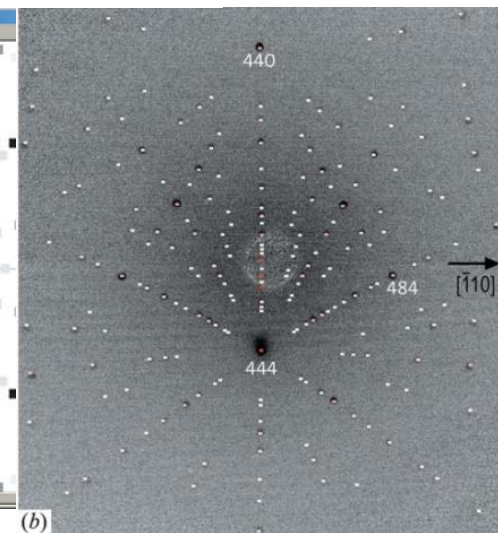
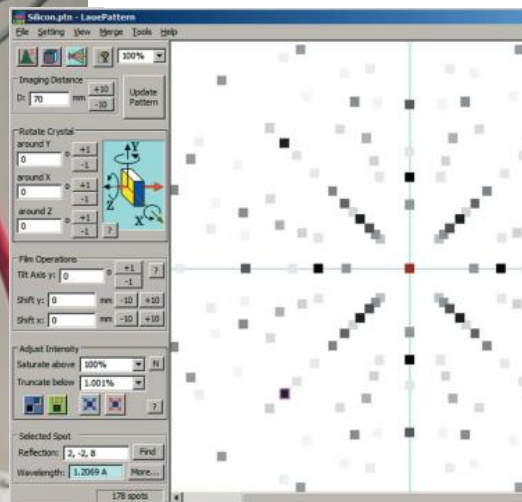
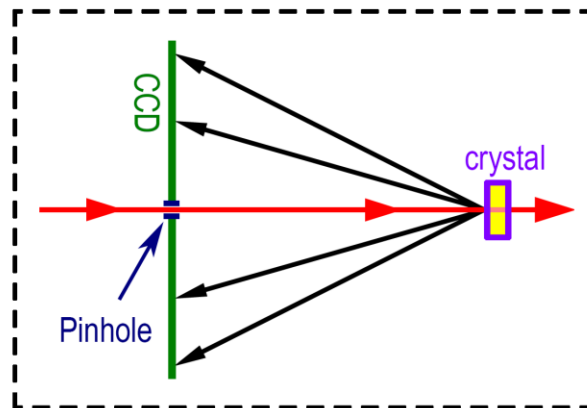
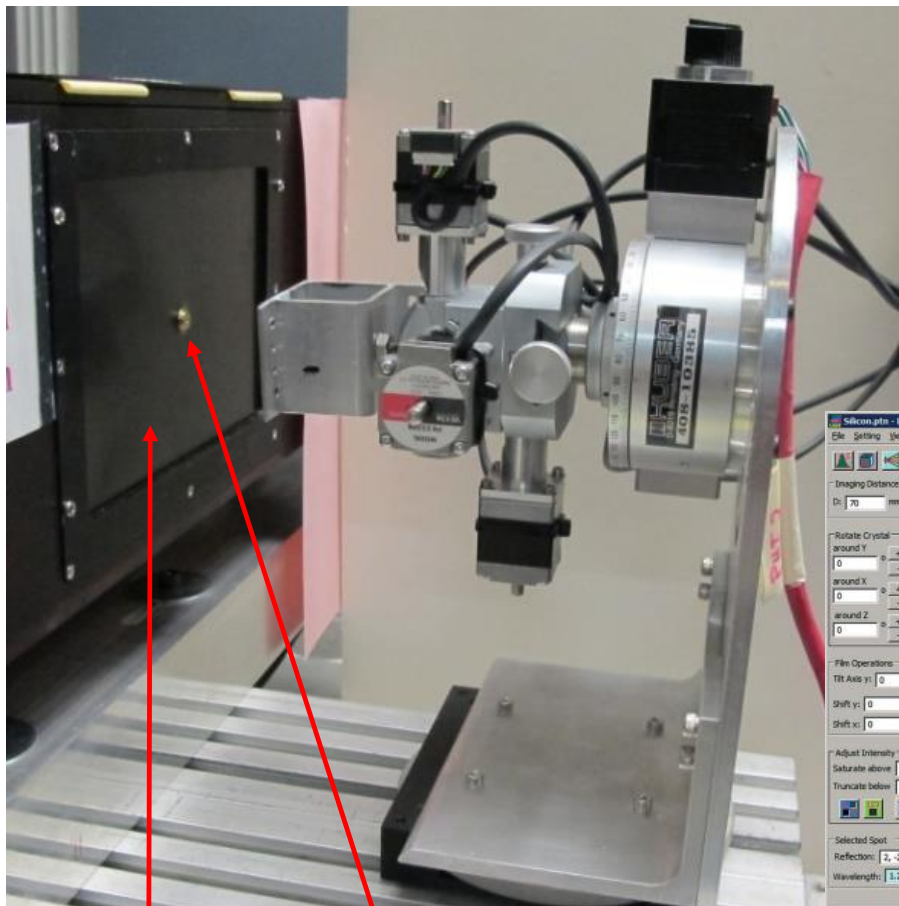

(b)

CCD

X-ray pinhole

LauePt software

X. R. Huang, *J. Appl. Cryst.* **43**, 926 (2010).

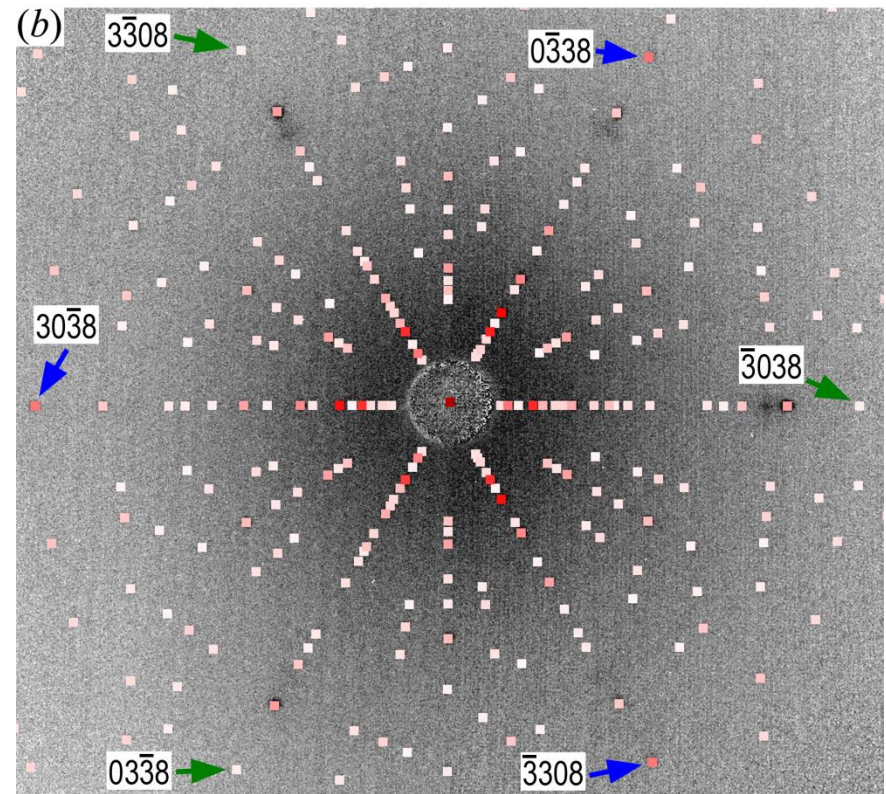
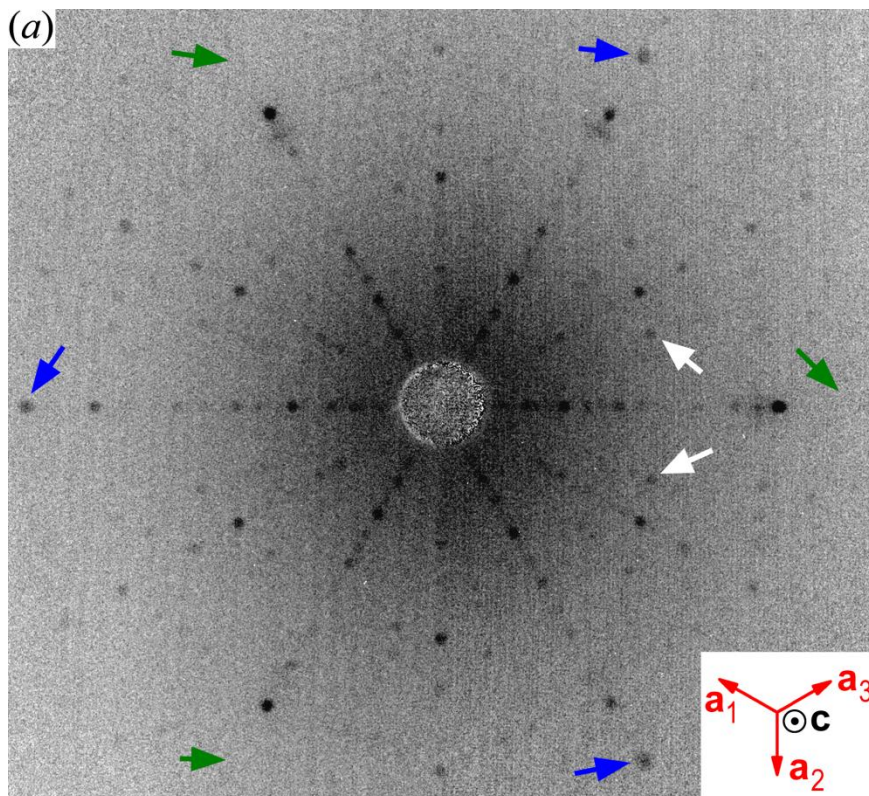

Laue pattern and simulation of quartz, X. R. Huang et al., *J. Appl. Cryst.* **51**, 140 (2018)

- The Laue camera has been mainly for large crystals Si and Ge.
- Now with our software LauePt, it works for ANY crystals.
- Increasing demands from users for orientating of small samples. We wish to upgrade with a higher-flux modern X-ray source to reduce exposure time, plus a high-precision automated goniometer, for real-time crystal rotation and alignment. (Currently an X-ray tube, exposure time 3-5 minutes.)

□ Cutting and dicing saws



- Meyer Burger Blade Saw for cutting large crystals (up to 0.5 m)

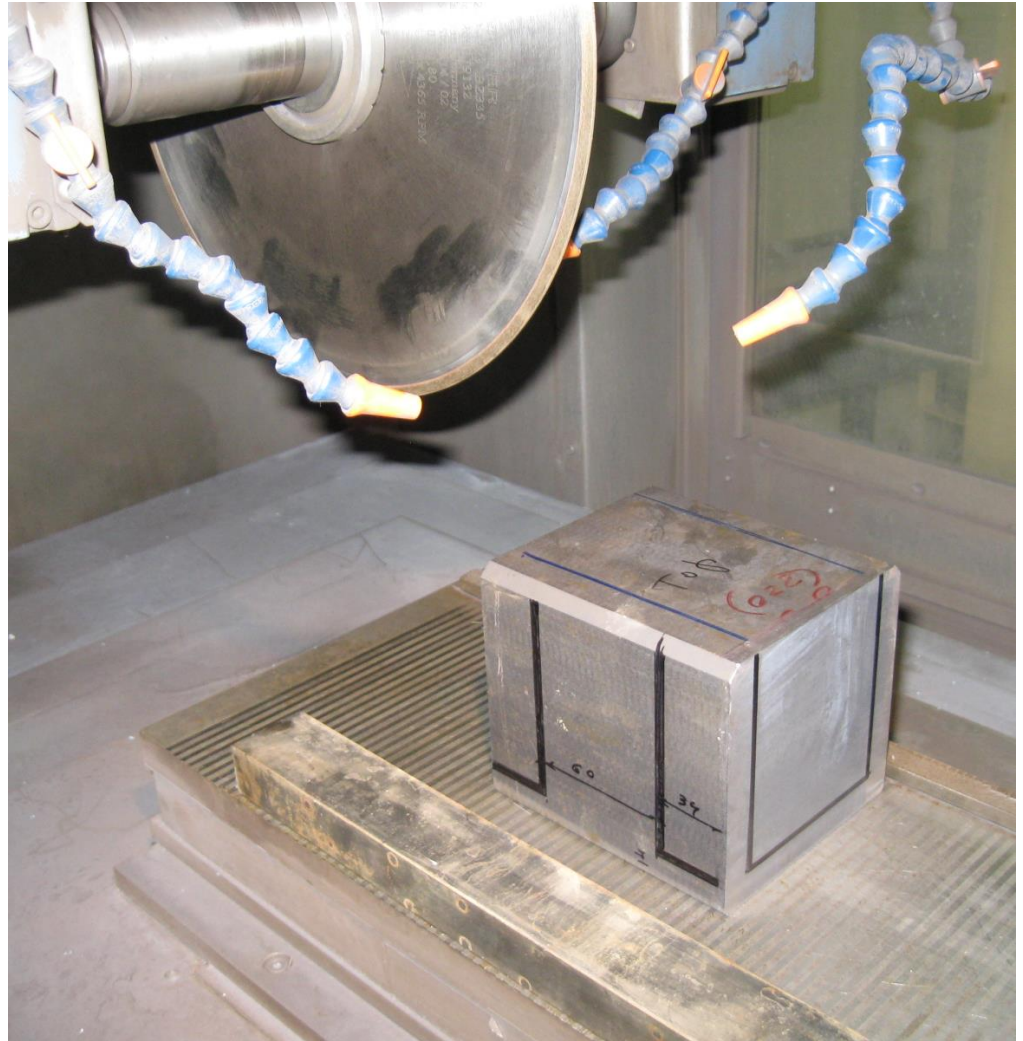



- **Diamond Wire Saw for gentle cutting, giving minimum strains and damages. Wire diameter 0.3 mm, consuming minimum material**

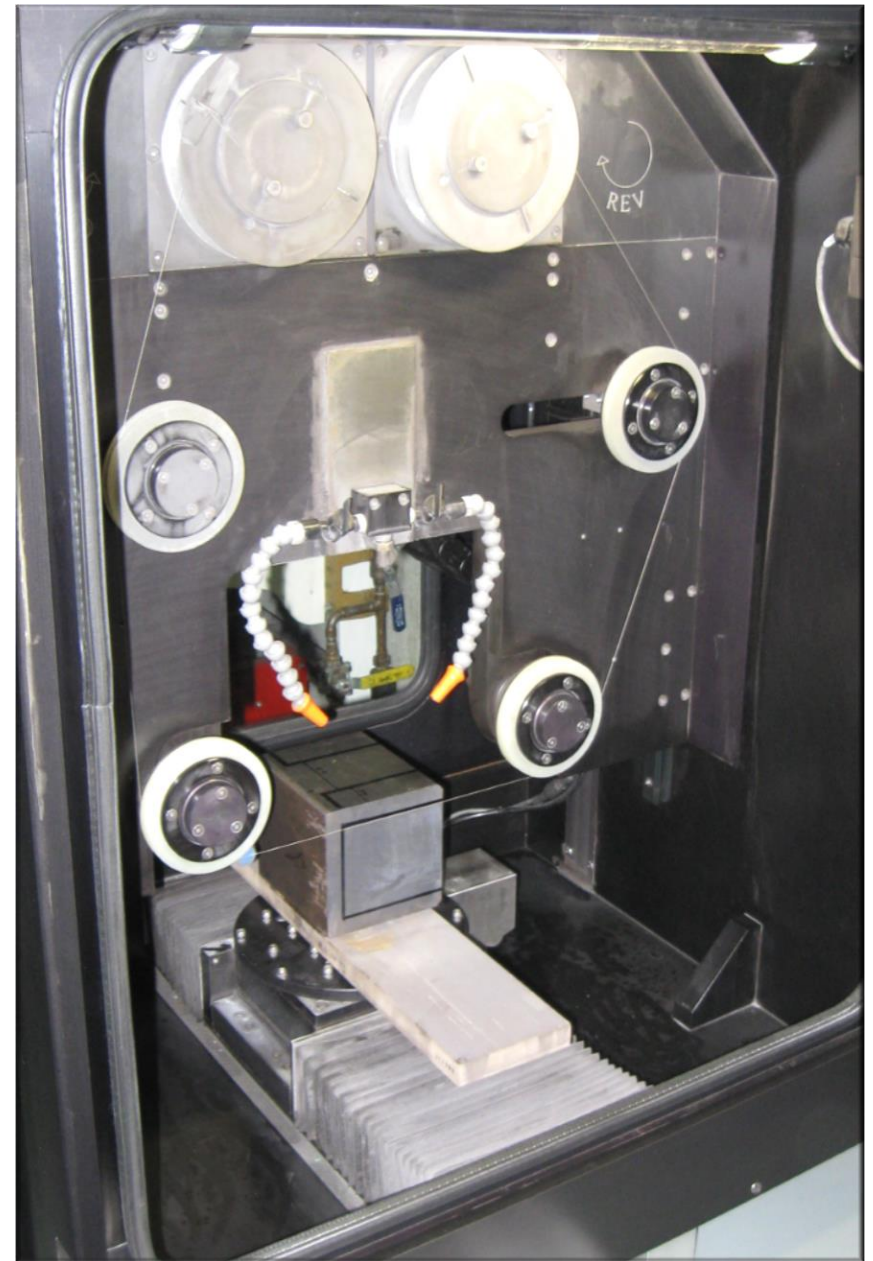

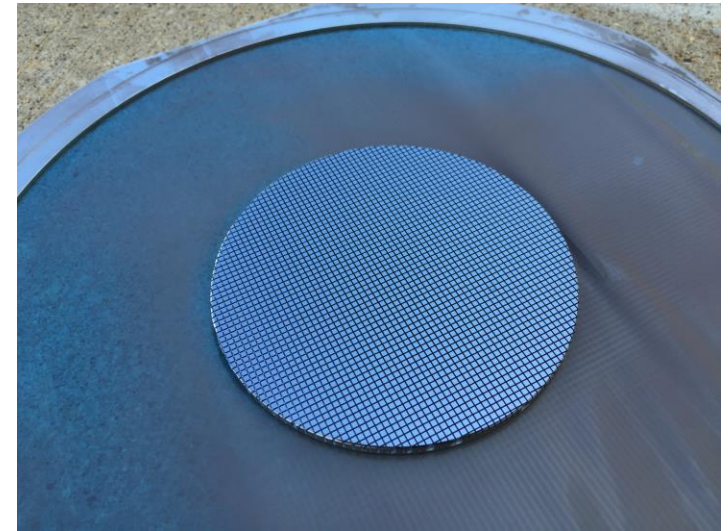

Diced Si wafer for making spherical analyzer

- **Two 4-inch-spindle high-precision dicing saws (cutting precision on μm level)**
- Mainly for dicing spherical analyzers.
- Also for delicate cutting of various optical components, samples, sample holders, fixture, etc., very productive.
- One is approaching the end of life, needs a replacement. A **2-inch-spindle** dicing saw has much higher precision while producing minimum strains, ideal for dicing quartz, but also for Si/Ge.

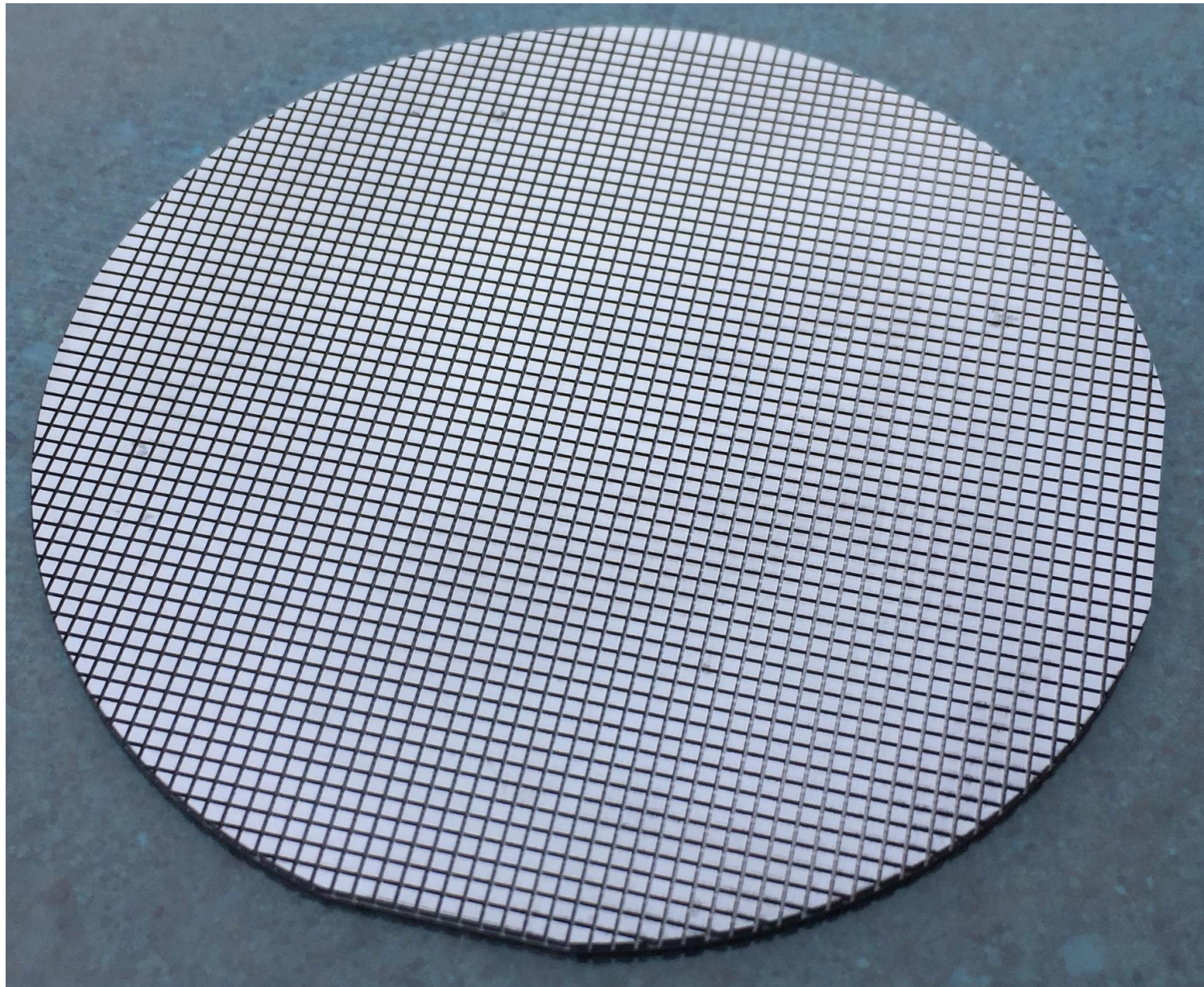

Diced spherical IXS analyzer (diameter 100 mm)



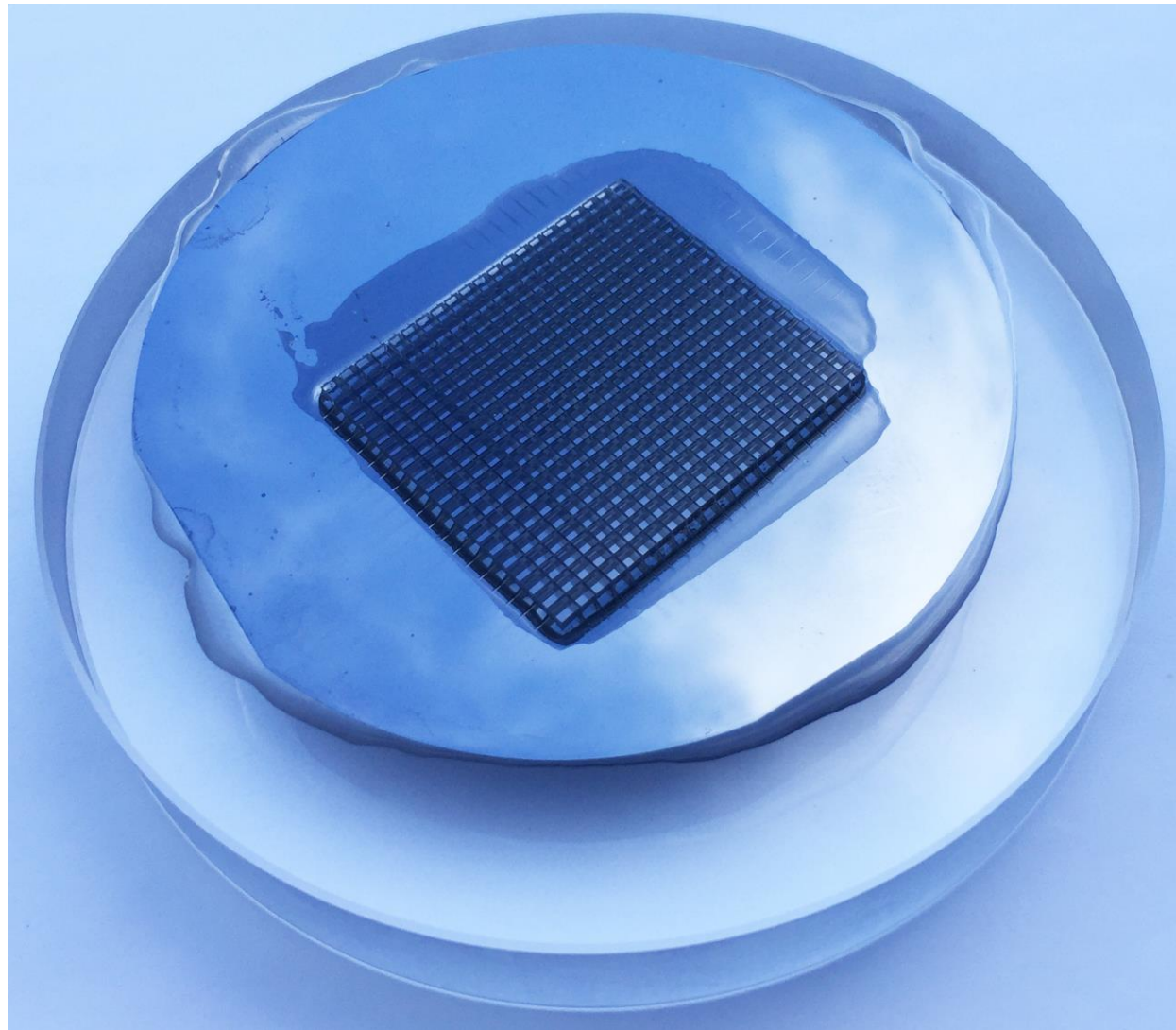

Diced Quartz analyzer

Grinding/machining (at the Central Shops)

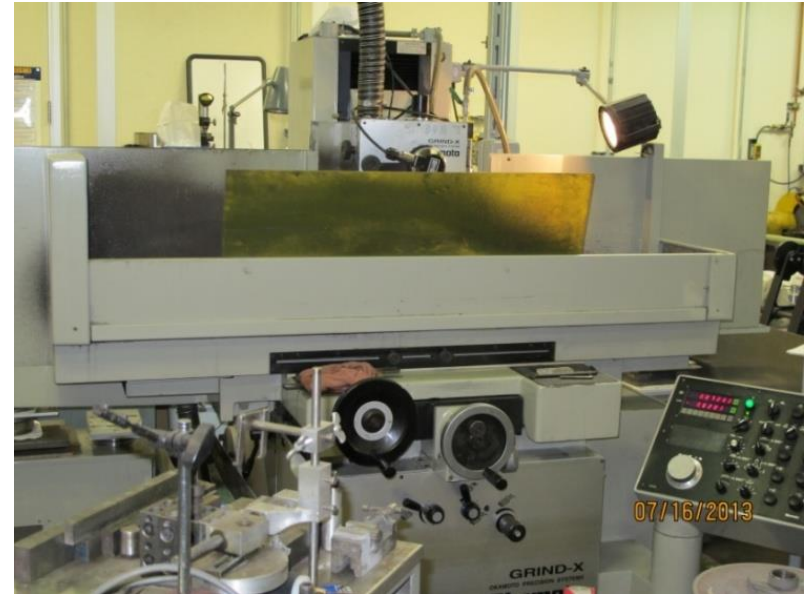

- **Two high-precision surface grinders** ↑
(with surface orientation precision $< 0.1^\circ$,
working with the **orienting fixture**) →

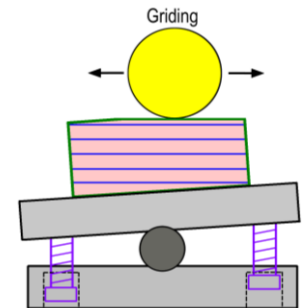

- **Surface grinding at the Central Shops is costly, > 4 hours per surface at a rate of \$105 per hour.**
- **Usually this is the only fabrication cost for work of APS operations.** The Optics Group does not charge labor and efforts except for material cost.

➤ Other machining tools

- Ultrasonic mill
- Drill
- ...

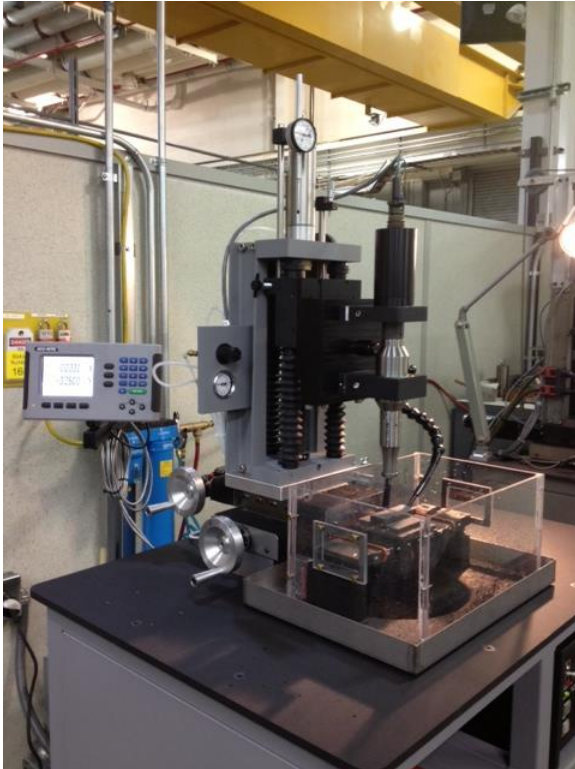

Drilling holes



Polishing

- A series of pad polishers for strain-free polishing

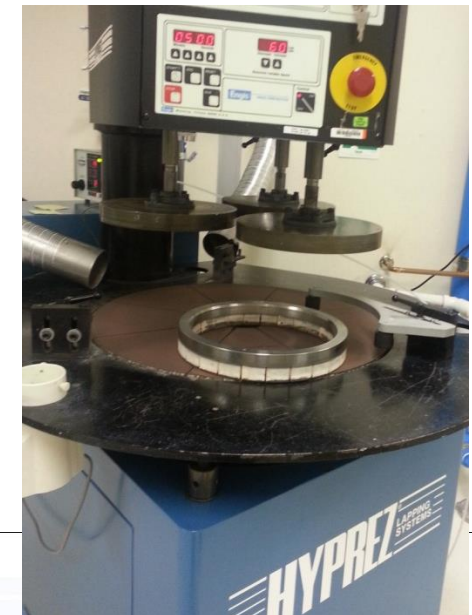
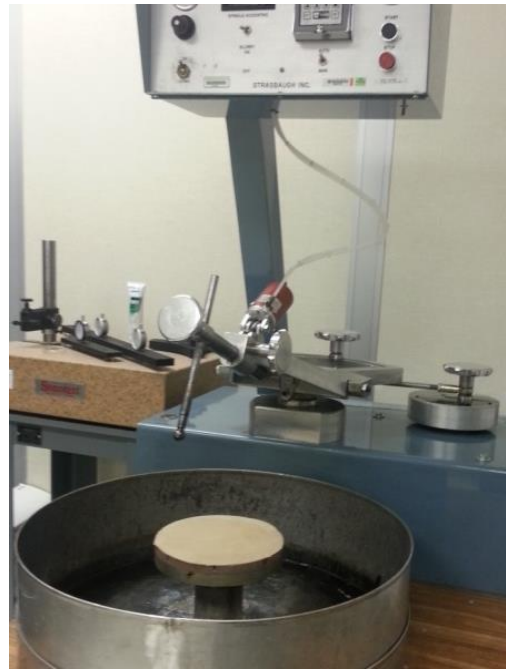
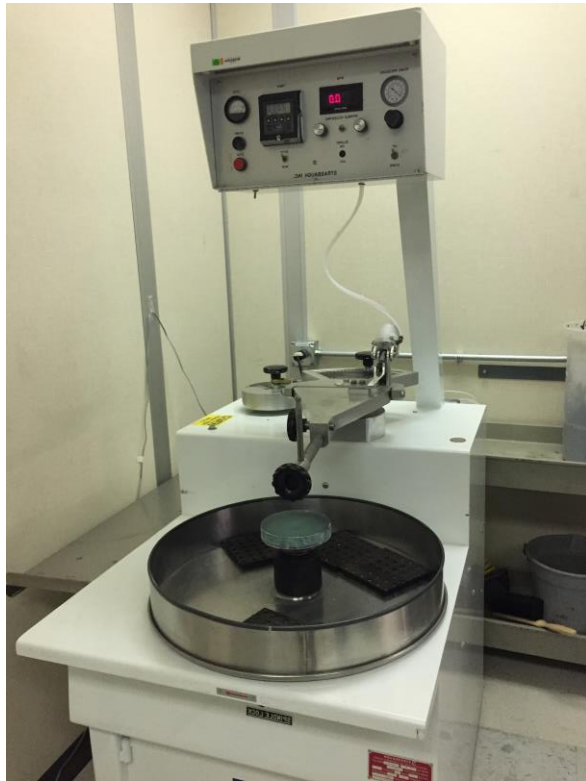

- Hyprez LM28 Lapper with 28" table for surface flattening →



Automated channel-cut polishing machine

being developed by Elina and Jon:

- Not only for channel-cut-type crystals
- but also for other crystals without a flat top surface, such as
 - Stepped surfaces
 - Thin crystal windows/beam splitters
 - Comb crystals
 -
- Well polished channel-cuts free of diffraction speckles, preserving coherence.

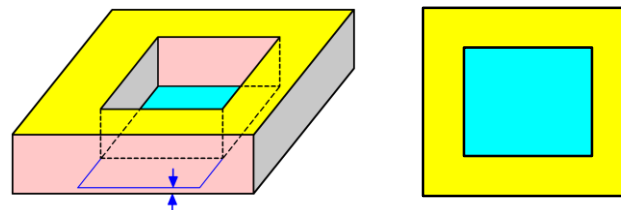
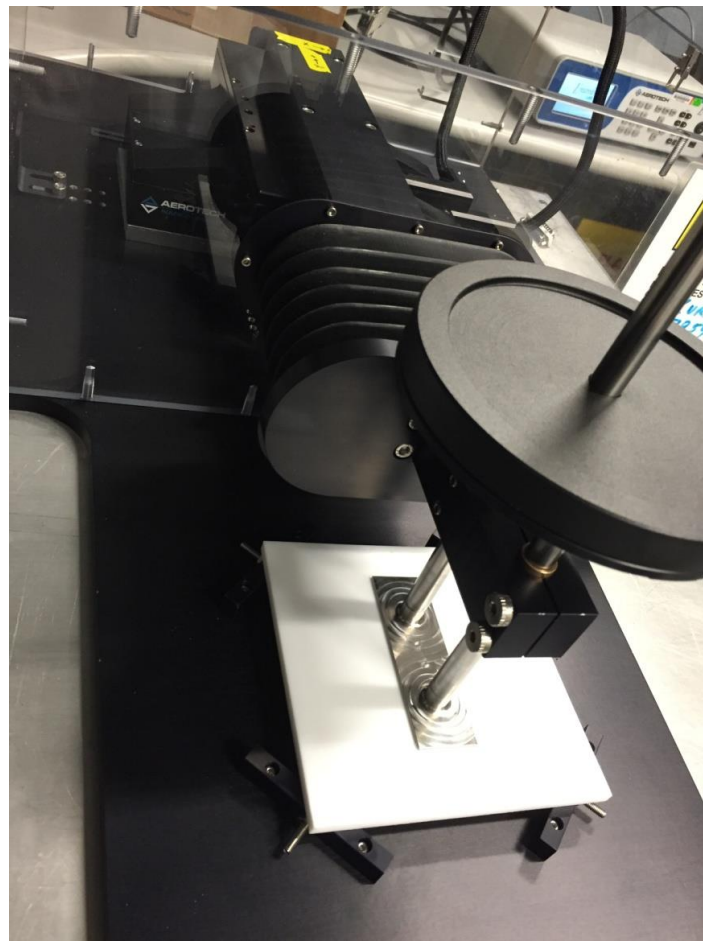

□ Etching

- Two etching hoods in the Etching lab, for HF and HNO₃ etching or other acids (HCl, H₂SO₄, etc)
- With complete safety PPEs, well developed procedures →

- Two annealing furnaces including a new Red Devil Vacuum Furnace for high temperature (>1000°C).



Unique crystal characterization capabilities

High-resolution double-crystal diffractometer (Topo Unit) for rocking curve imaging and strain mapping of crystals up to 10cm x 10cm viewfield

- For monitoring the quality of fabricated crystal optics
- For optimization/diagnostic of monochromator mounting by strain mapping
- **Not operational now.** The old rotating anode source needs replacement. Critical for crystal optics mounting and testing during APS shutdown time.

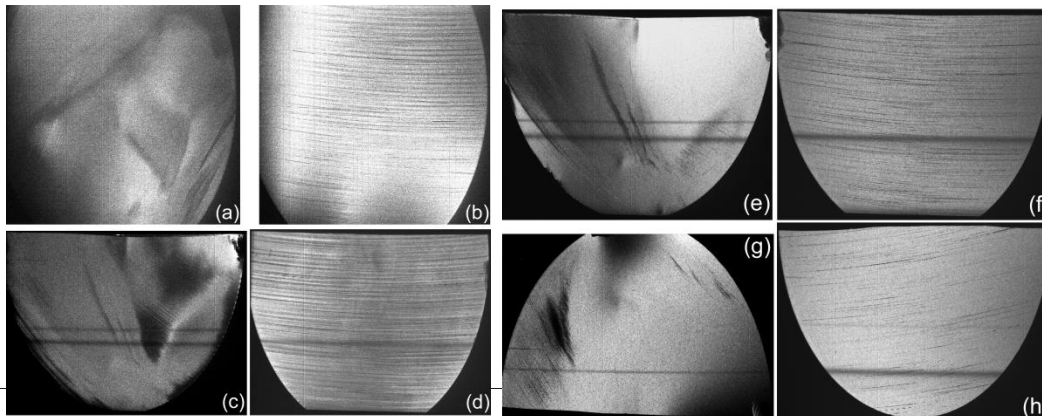
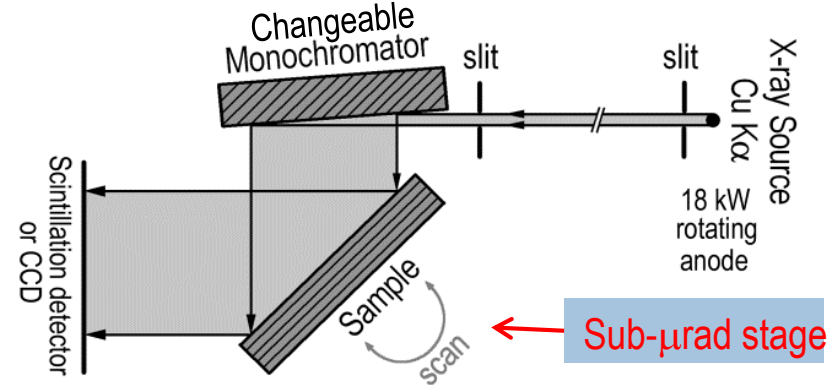
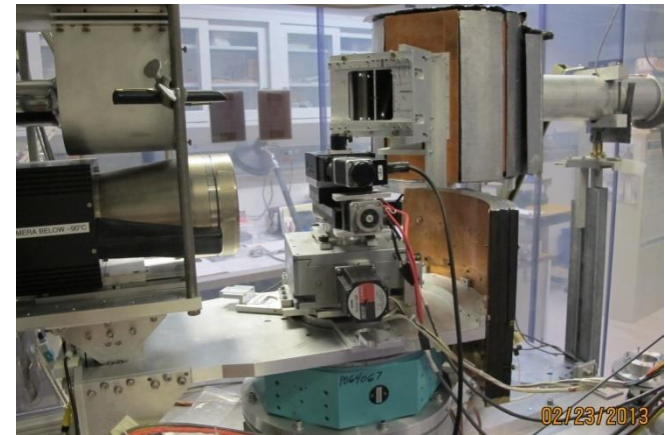

← Double-crystal X-ray topographs of strain mapping taken in different processing phases during fabrication. 333 symmetric reflection. The Si wafer size is 4 inches in diameter.

White- and Mono-beam X-ray Topography at APS Optics Testing Beamline 1-BM

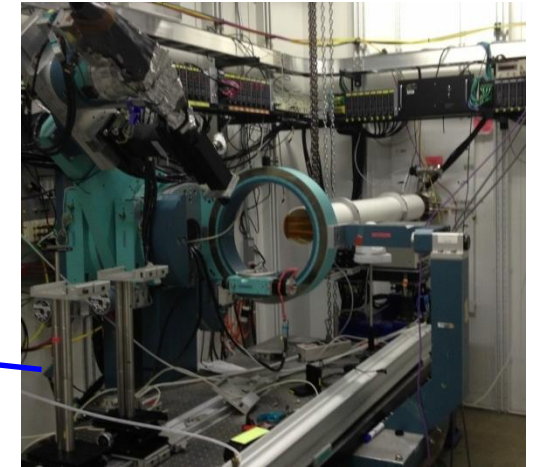
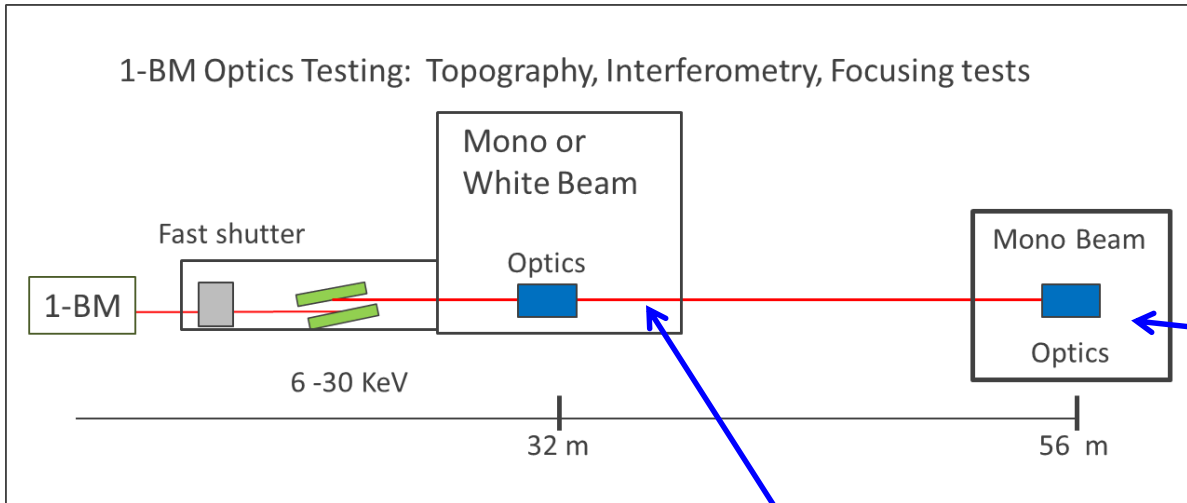

Station 1-BM-C, 6-circle diffractometer for mono topography

- ❑ Characterization of single crystals and a wide range of related research
- ❑ Crystal-based X-ray optics test & development
- ❑ Industrial applications, crystal growth and epitaxy characterization, semiconductors, solar/energy materials...



Station 1-BM-B, white-beam topography

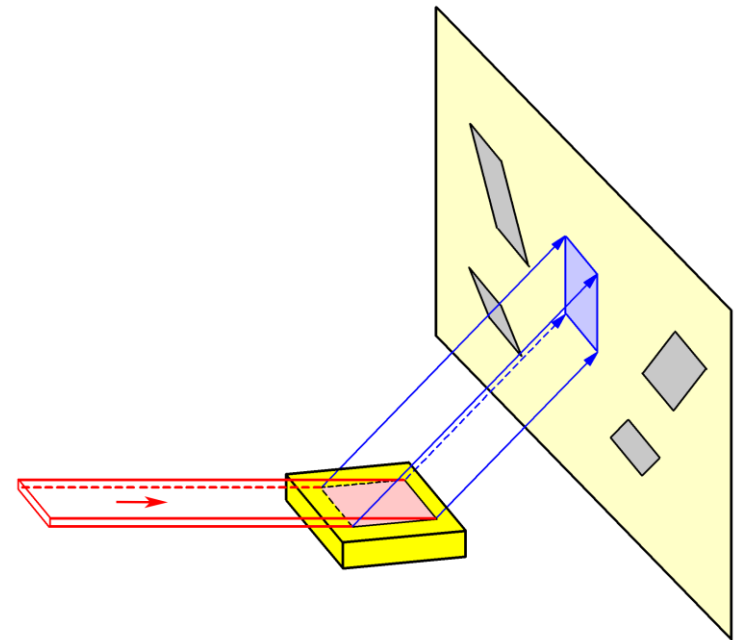
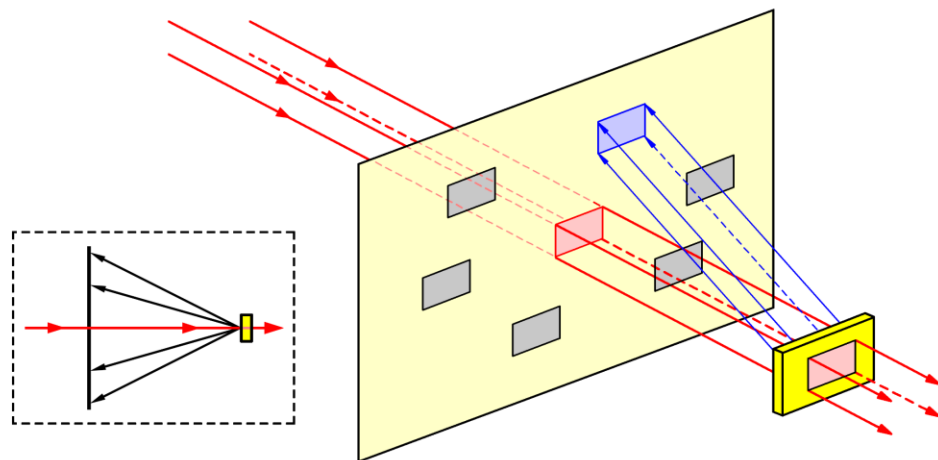
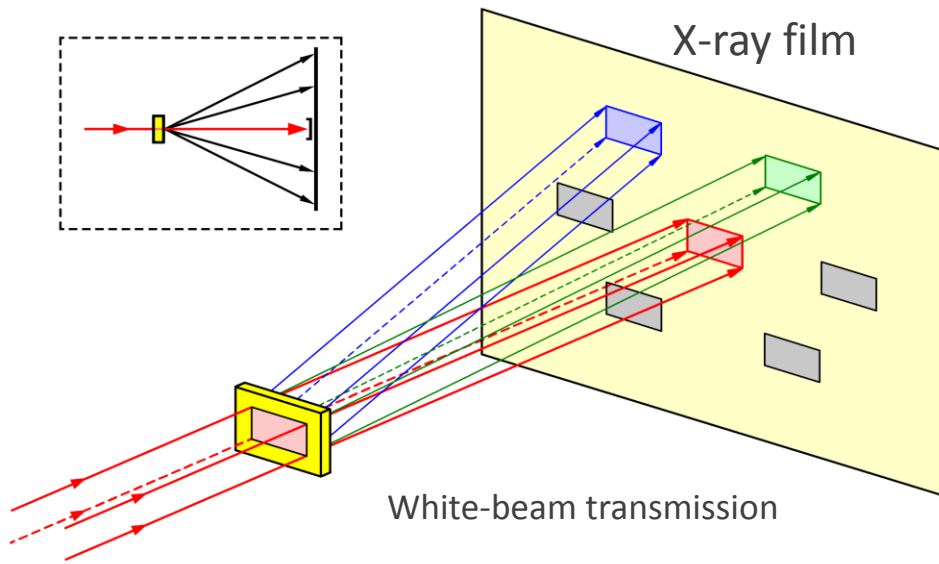



White-beam transmission Laue pattern recorded on X-ray film, each spot is a topograph

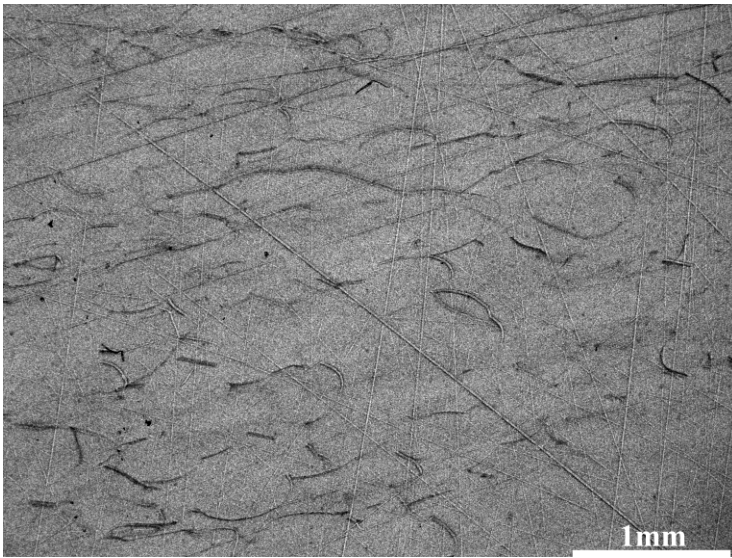

White-beam topograph of sapphire showing dislocations and polishing scratches

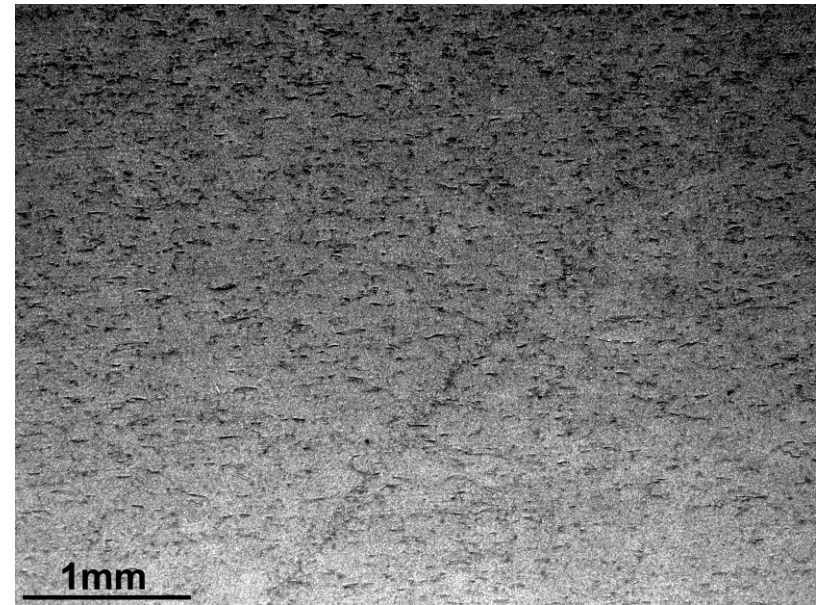

White-beam topograph of LiNbO3 showing dislocations



White-beam topograph of Si showing machining damages and strains

White-beam topograph of a diamond crystal intended as the mono for the APS-U CHEX beamline --- Mosaic structure, most likely CVD growth, not good!

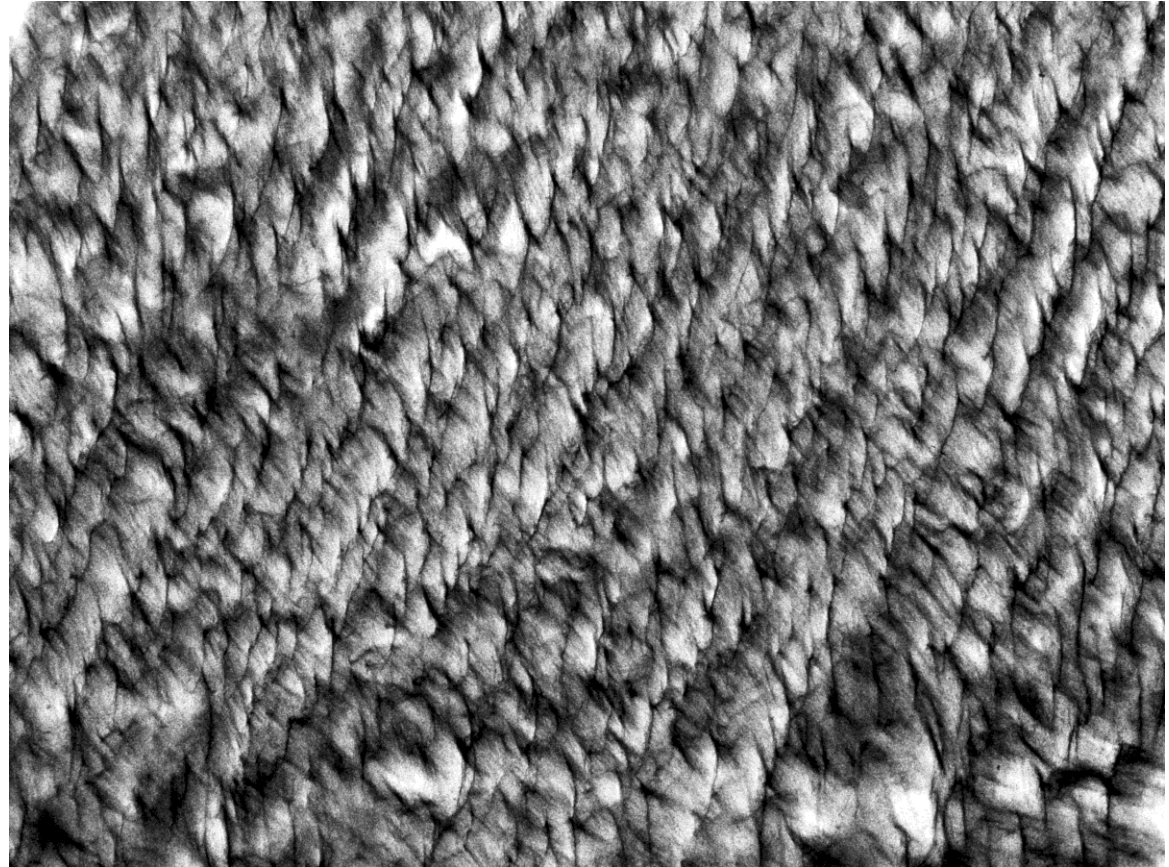
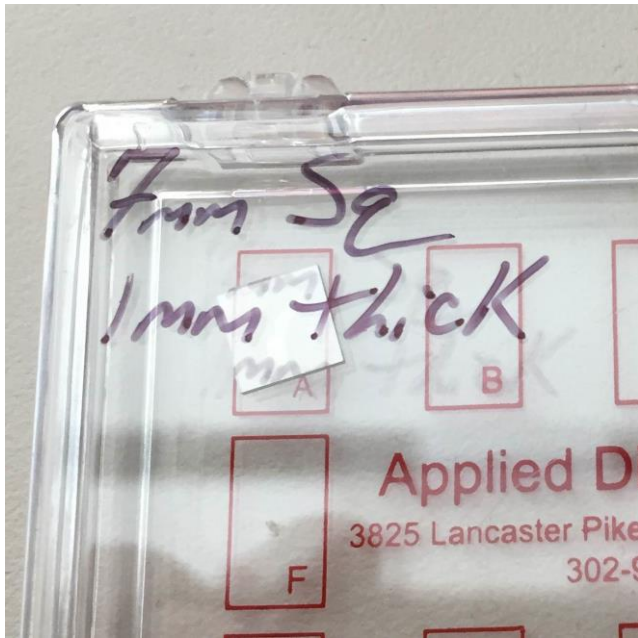

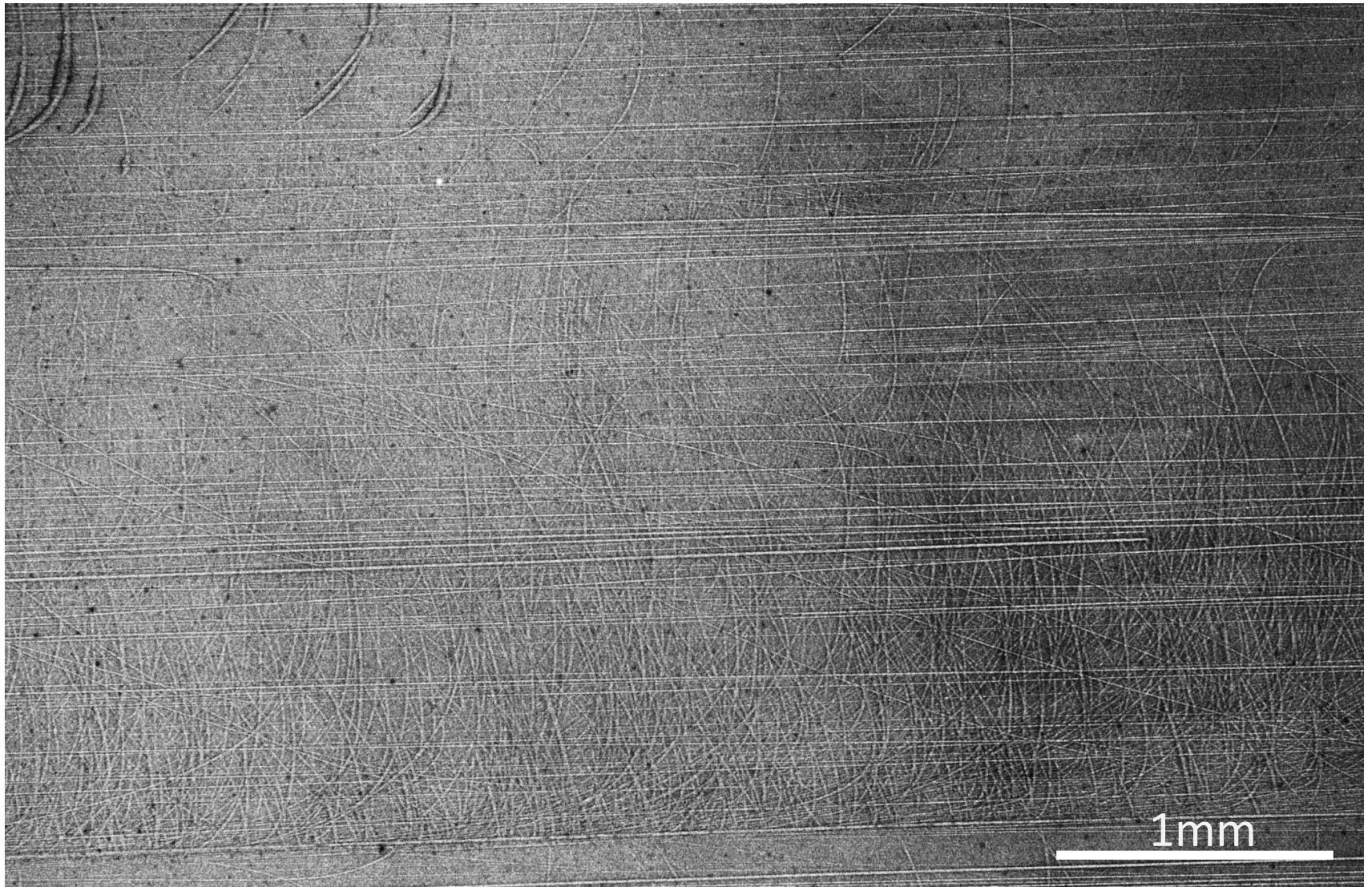

White-beam topograph of Si with high-sensitivity to polishing scratches, an important technique for checking crystal surface quality and for developing polishing techniques.

Monochromatic-beam topography

(with much lower noises, but need accurate crystal alignment)

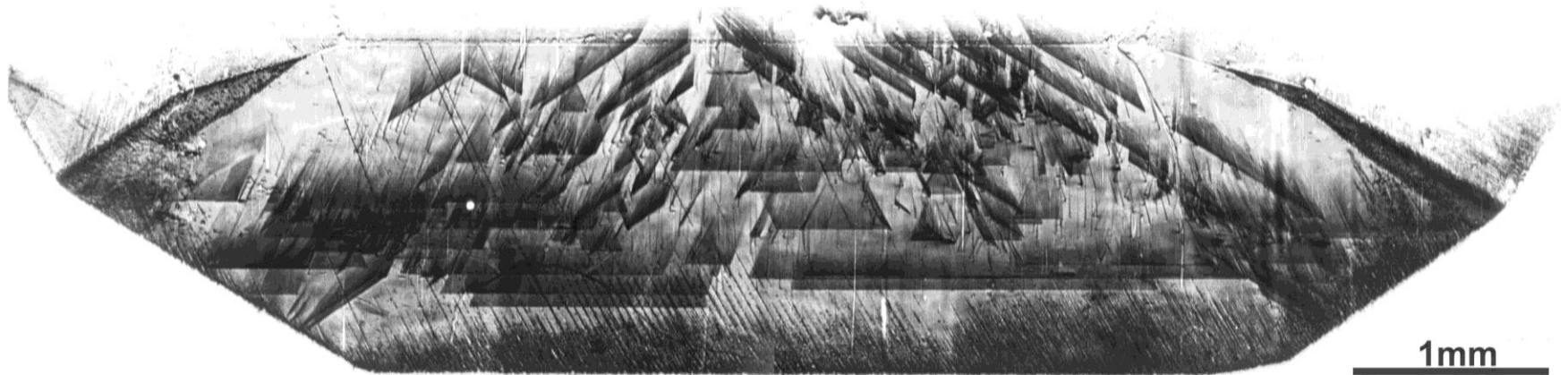
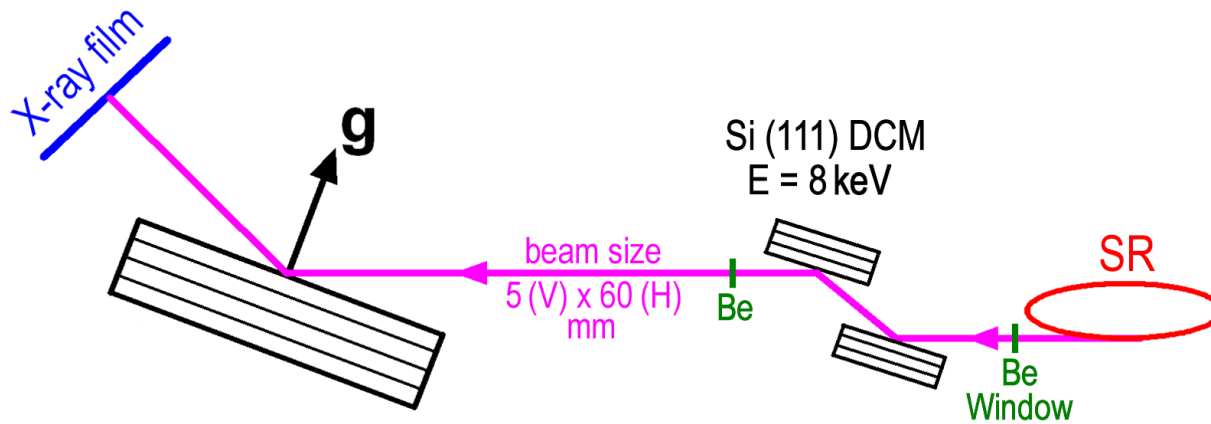

Monochromatic-beam topograph of Type IIa diamond showing stacking faults and other defects

Double-crystal rocking curve imaging at APS beamline 1-BM

For even higher-resolution rocking curve measurements and for strain mapping (μm -spatial resolution)

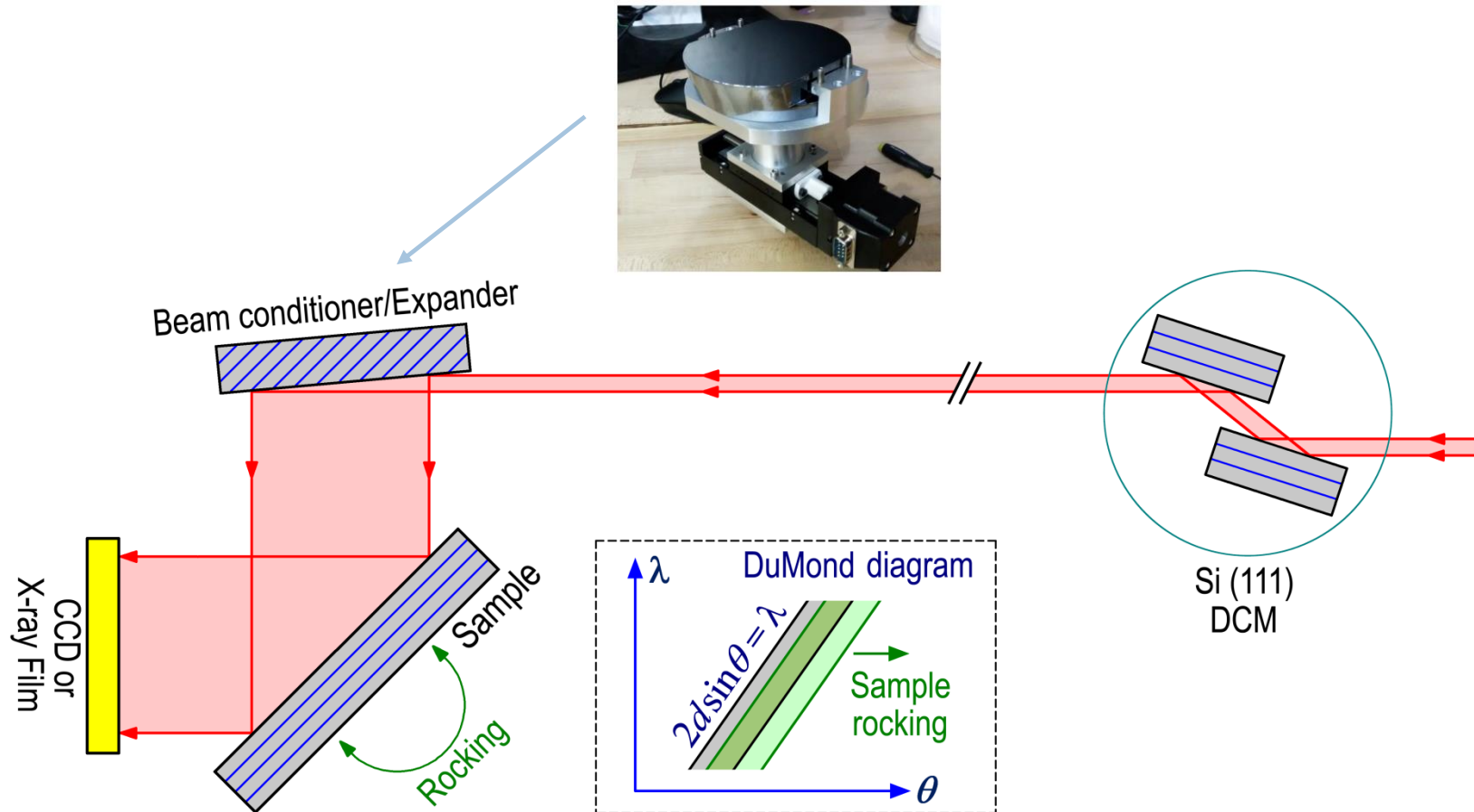

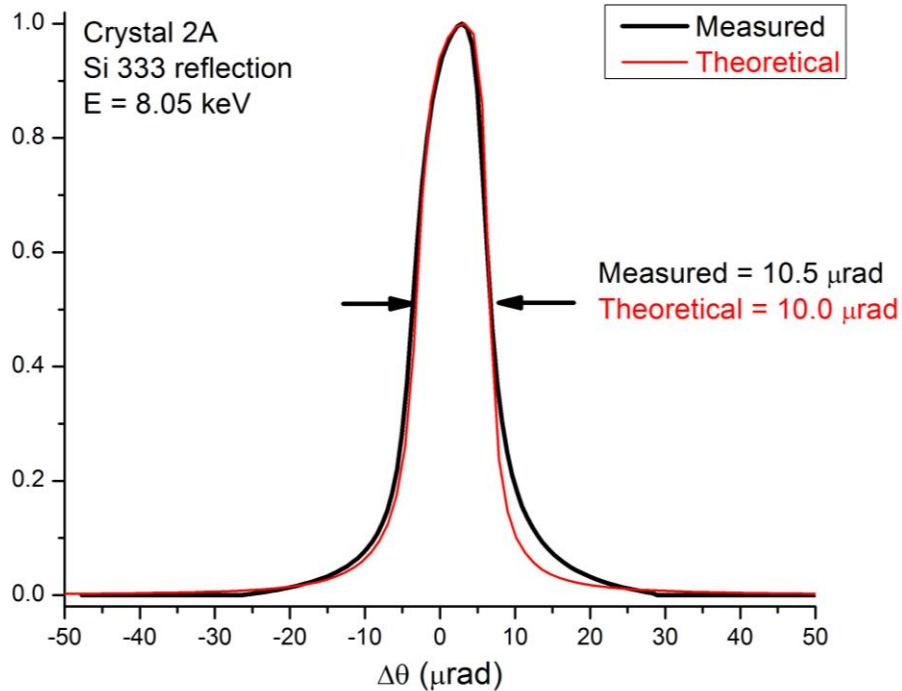

Measured double-crystal rocking curve compared with simulation

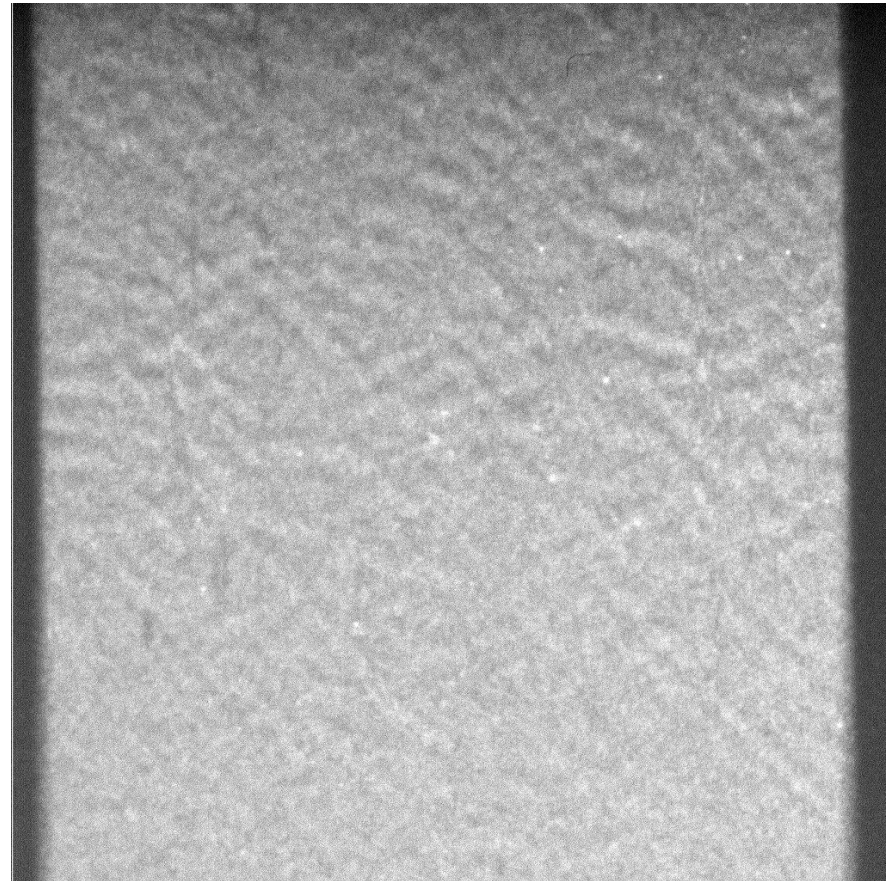

Topograph (on rocking curve peak) recorded by CCD shows no strains or defects (the weak contrast is from Be windows)

Adjusting mounting of DCM to minimize strains by Rocking Curve Imaging

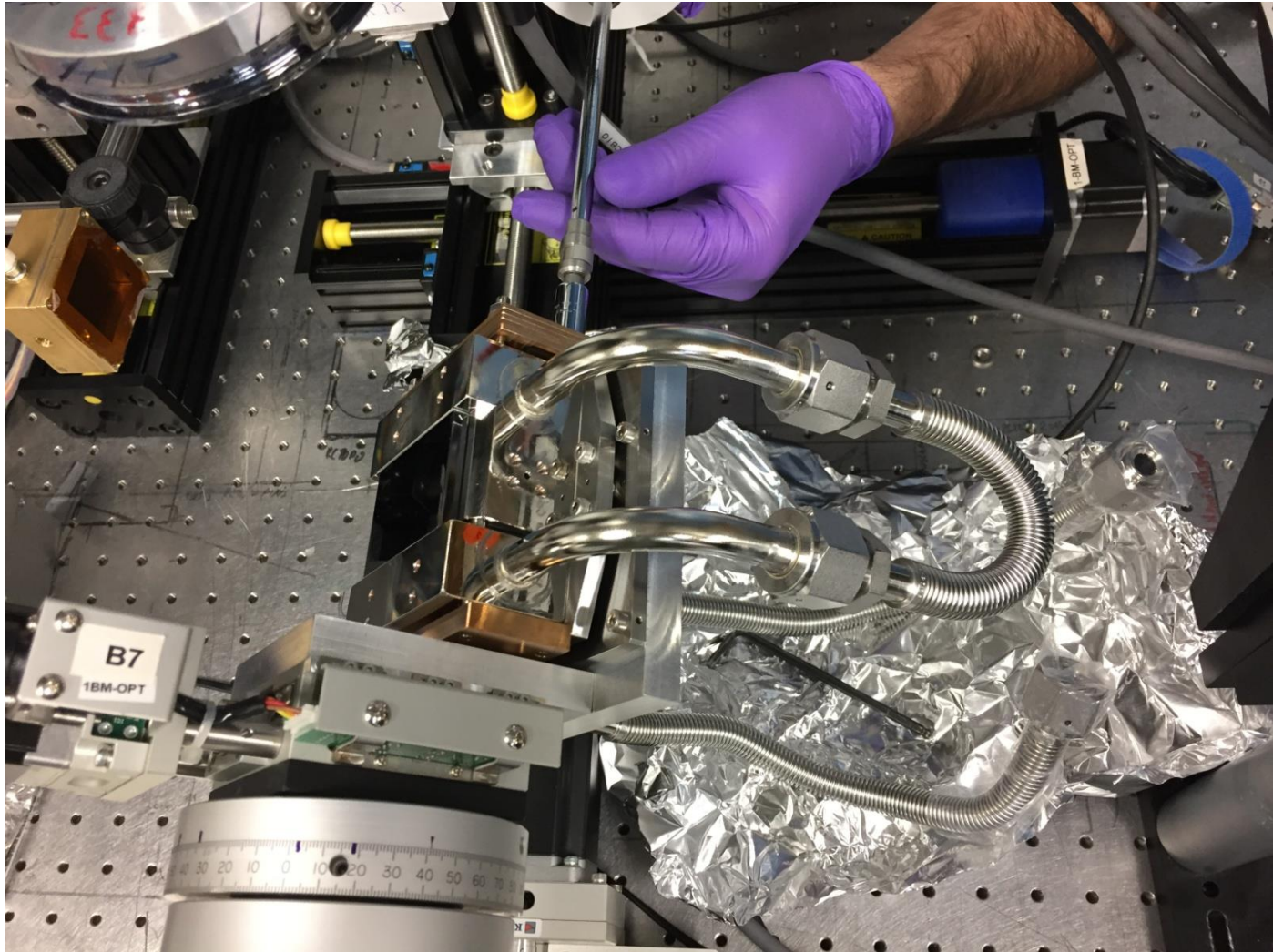

The characterization tools at APS are unique in the USA, can guarantee the crystalline quality of crystal we purchased, and the quality of crystal optics we fabricated and installed. Crystal vendors do not have such capabilities!

Expertise on crystal optics design

We have developed our own dynamical-theory programs for design and modeling of monochromators and analyzers based on users' requirements (resolution/bandwidth, angular acceptance, efficiency, etc.)

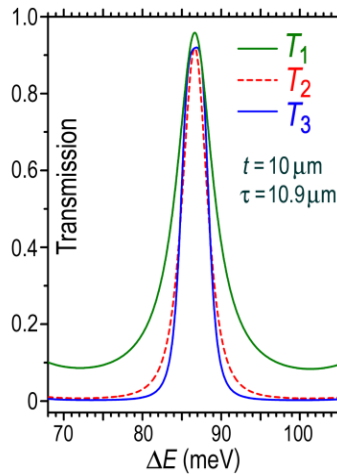
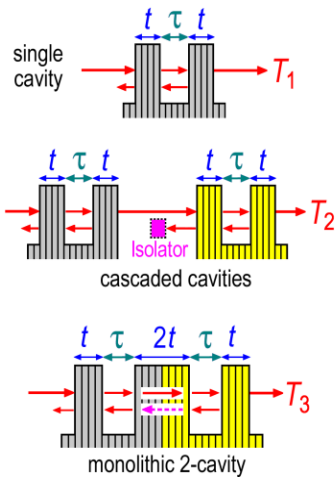
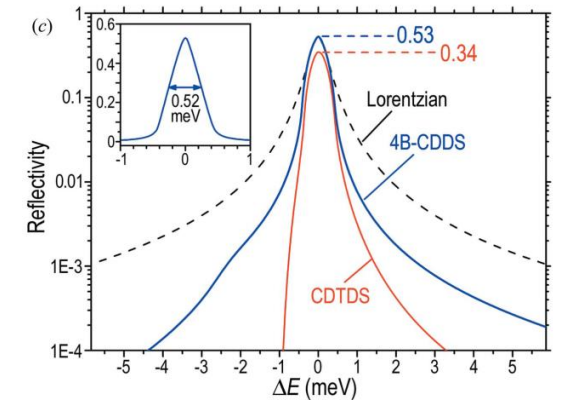
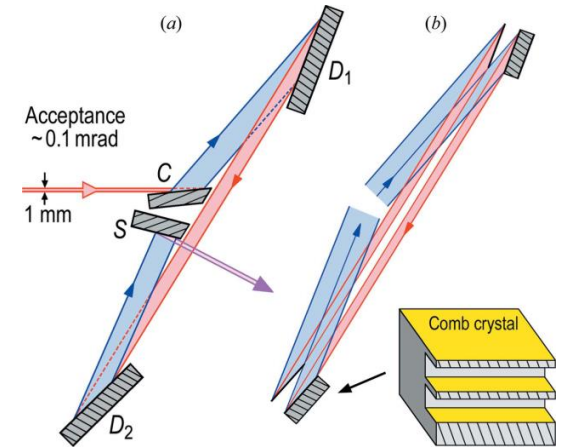
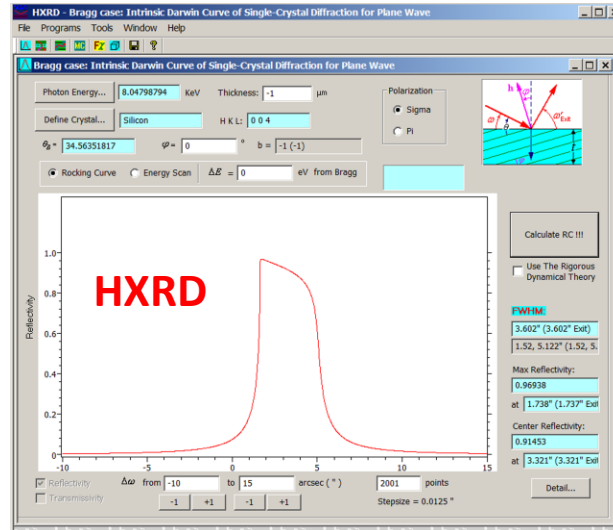

- Multiple diamond crystal cavities for unlimited X-ray energy resolution and coherence [X. R. Huang et al., *Phys. Rev. Lett.* **108**, 224801 (2012)]



- Design and modeling of a sub-meV 4B-CDDS IXS analyzer ↑
X.-R. Huang, *JSR* **18**, 899 (2011)



0.7 meV sub-meV ultrahigh-resolution IXS monochromators designed by APS/OPT for NSLS-II

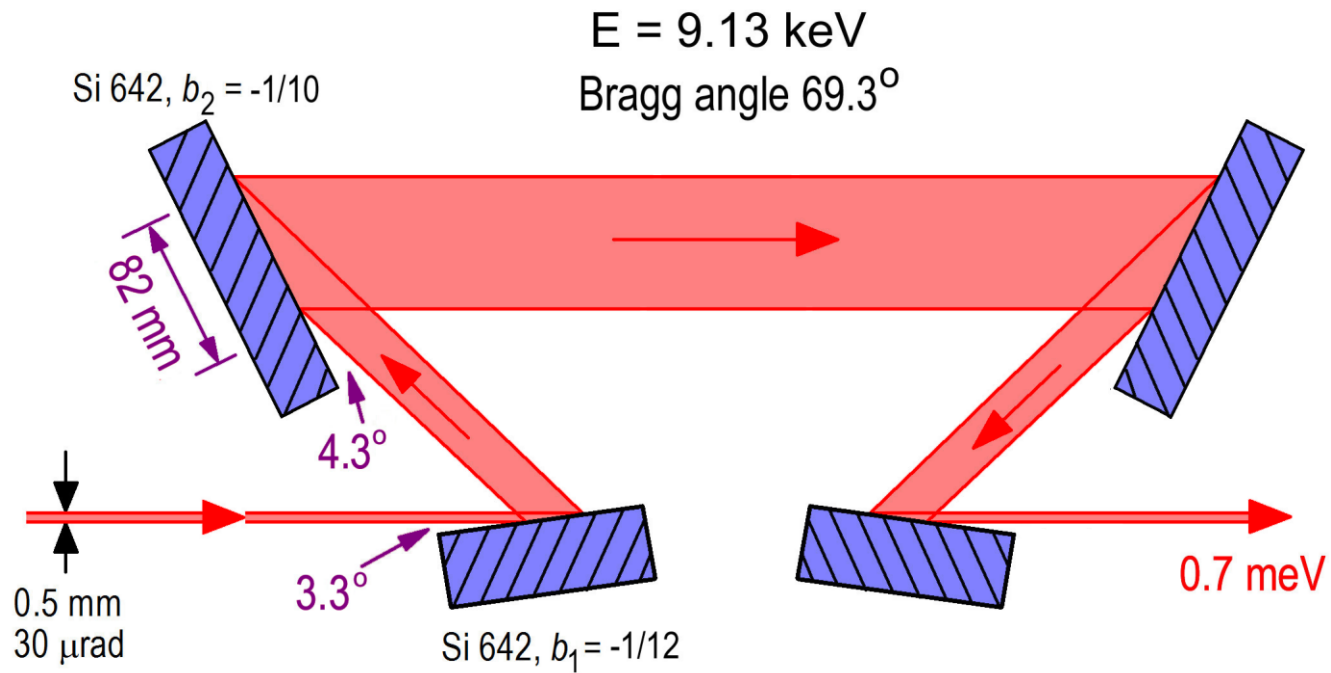

Successfully implemented at the IXS beamline of NSLS-II with designed resolution and performance

Inline nested channel-cut mono

To avoid the offset D_V

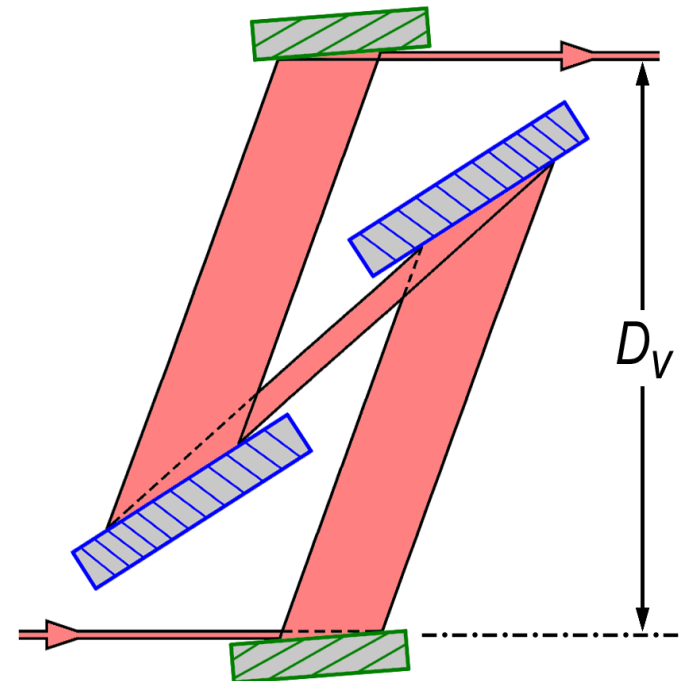
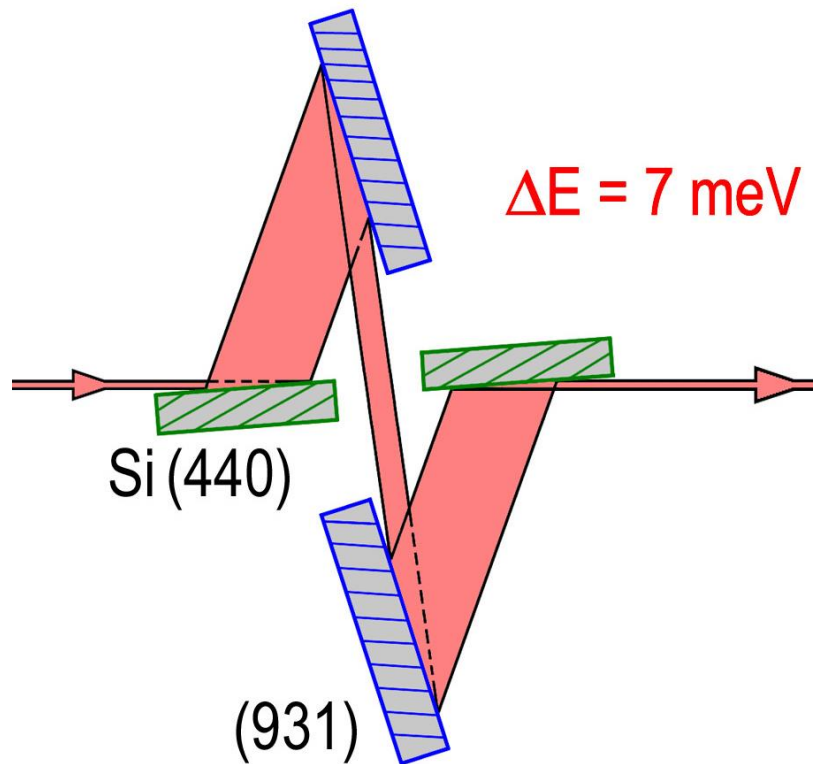

$E = 11.215 \text{ keV}$



Regular Operation

- Crystal Optics Fabrication:
 - Orienting
 - Cutting / Dicing
 - **Grinding and machining at the Central Shops**
 - Etching
 - Polishing
 - Characterization/testing
- Fill ~150 work requests per year, fabricating/processing the majority of crystals for APS beamlines/CATS and R&D (>300 crystal components). A small portion of the crystals, ~5%, are for external laboratories, including LCLS/SSRL, ORNL, CLS, LNLS, ALS, NSLS-II, CHESS etc
- **Cost charged to users consists of two parts:**
 - Material cost (highest-quality float-zone Si or Ge)
 - Machining cost at the Central Shops (expensive, beyond our control)
 - OPT efforts are mainly free to users: design, orientation, fabrication, **crystal optics refurbishing**, characterization, etc.
- Keep improving fabrication efficiency without scarifying quality, **cost effectively, average cost as low as 1/3 of commercial companies.**
- High customization: Any design, any shape, any requirements, easy modification, repair, refurbishing, ...
- Guaranteed high quality based on our unique characterization tools.



R&D Examples



Development of quartz optics and sub-10meV RIXS spectrometers

(in collaboration with Thomas Gog's team in IXN Group)

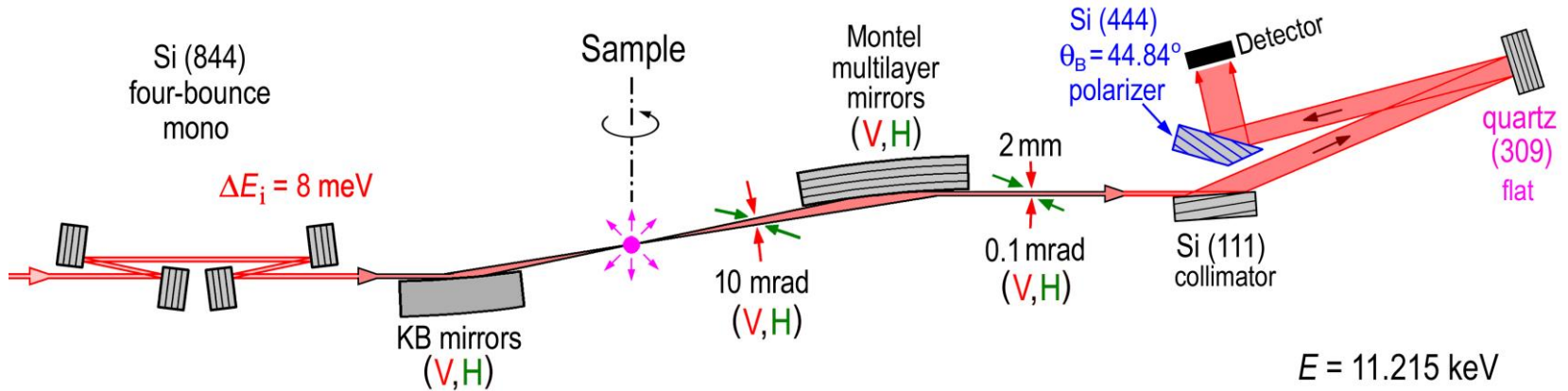

Novel flat-quartz analyzer combined with Montel mirror

Deconvoluted resolution ~ 4 meV for RIXS, achieved at Sector 27

J.H. Kim *et al.*, Scientific Reports **8**, 1958 (2018)

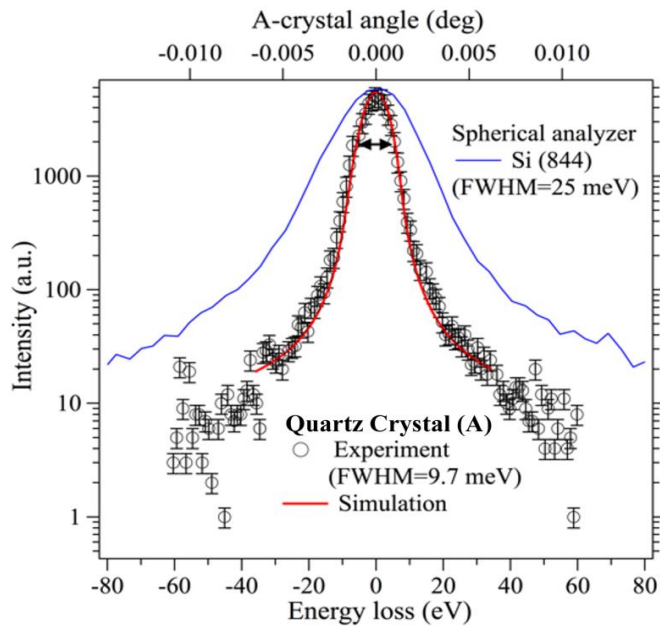

- Quartz is the third highest-crystalline-quality crystal almost comparable to Si and Ge.
- Quartz has hundreds to thousands of different Bragg reflections (compared with tens for Si).
- Quartz **analyzers** can be designed almost at any energies (absorption edges, emission lines)

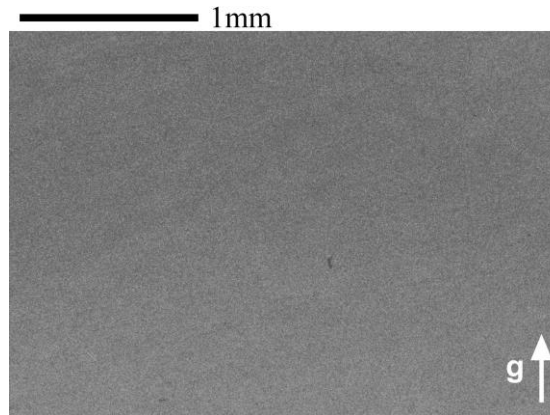
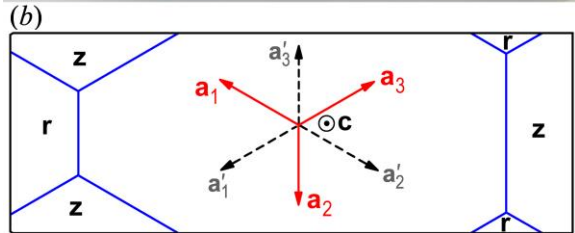
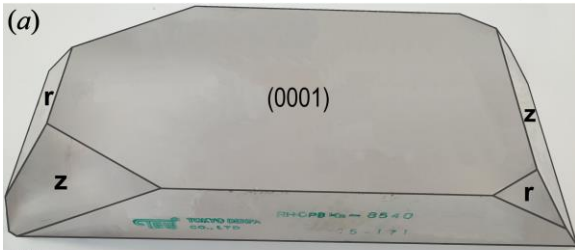

X-ray topograph showing no dislocations

Nearly dislocation-free large single-crystal quartz
220mm x 85mm x 40mm



100 mm

Successful dicing of quartz

A. Said et al., *J. Synchrotron Rad.* **25** (2018) 373.

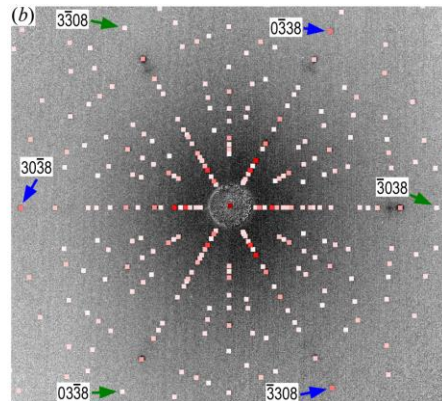
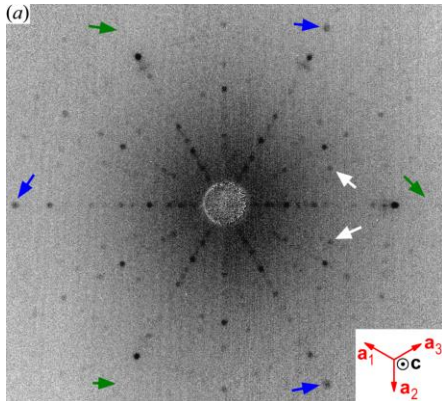

X. R. Huang et al., *J. Appl. Cryst.* **51**, 140 (2018)

Established complete procedures for quartz fabrication: design, orienting, dicing, etching, polishing, characterization.



Developing sapphire-based non-dispersive monochromators

Collaboration with DESY

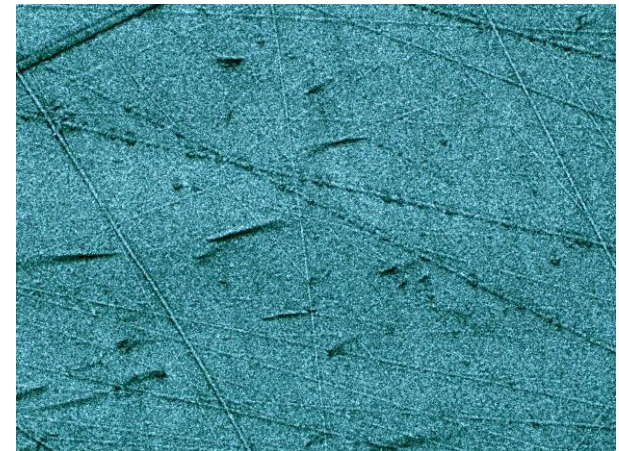
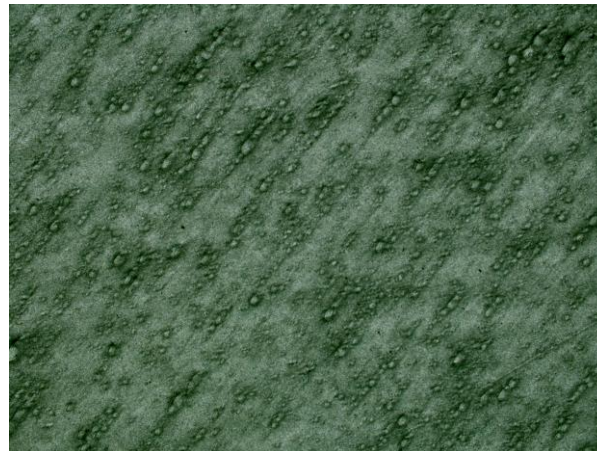
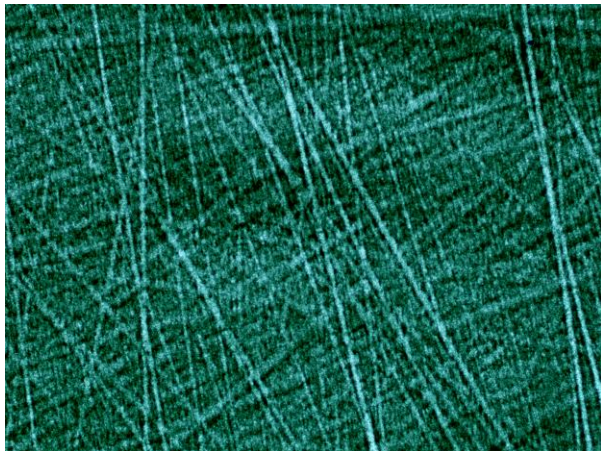
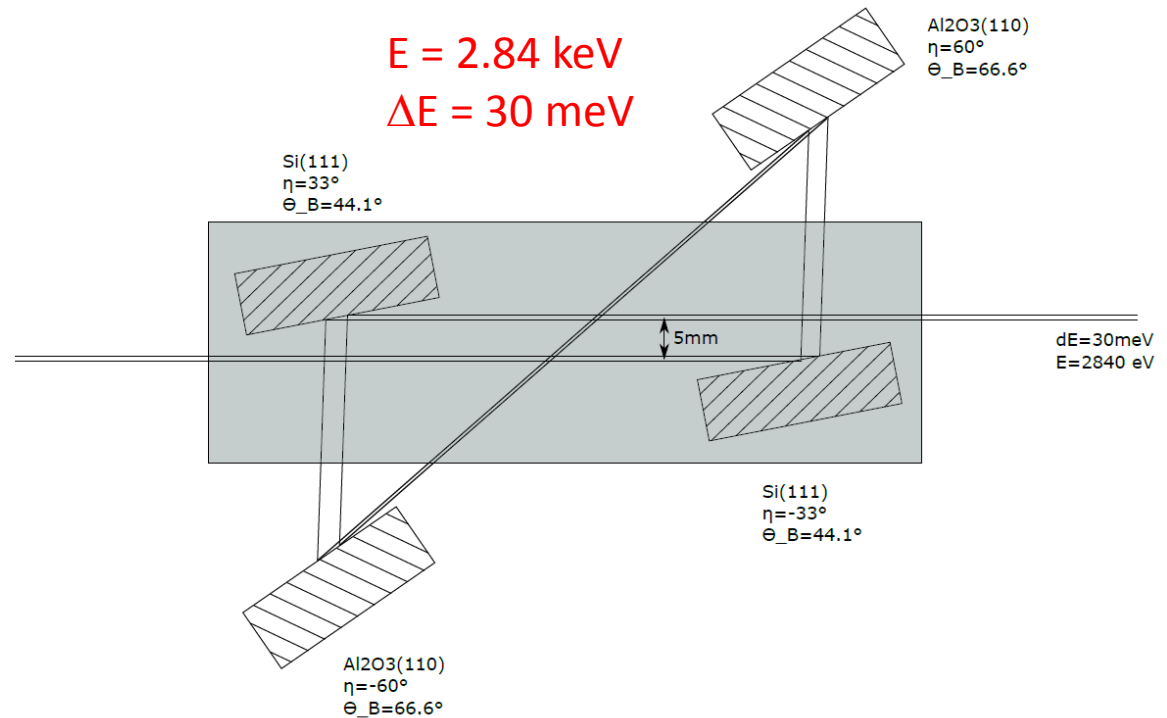
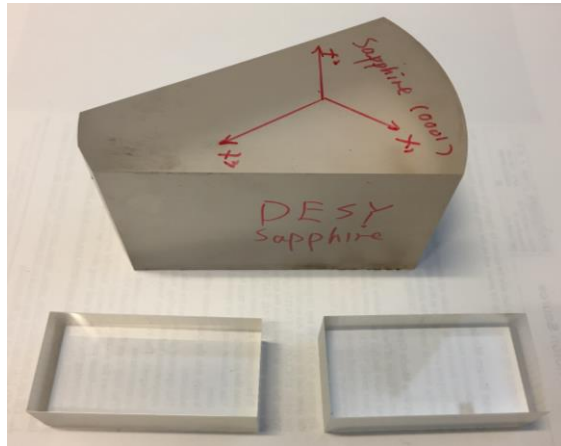

White-beam topographs taken during various polishing stages for establishing reliable polishing techniques for sapphire



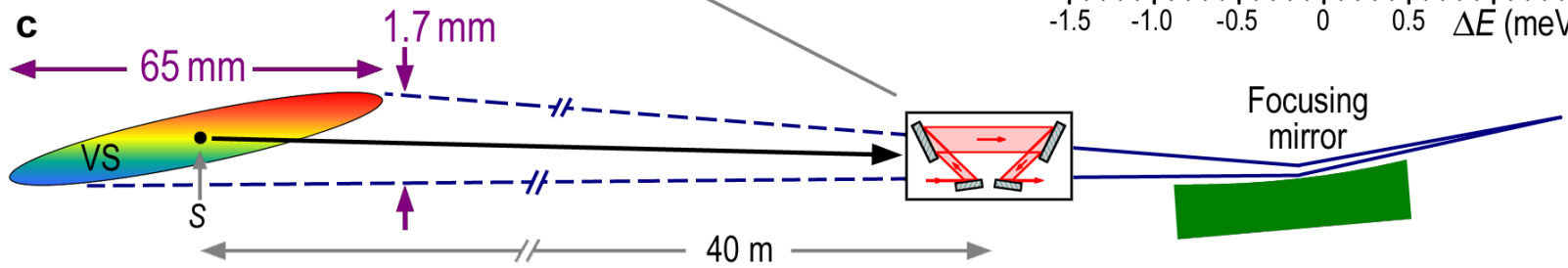
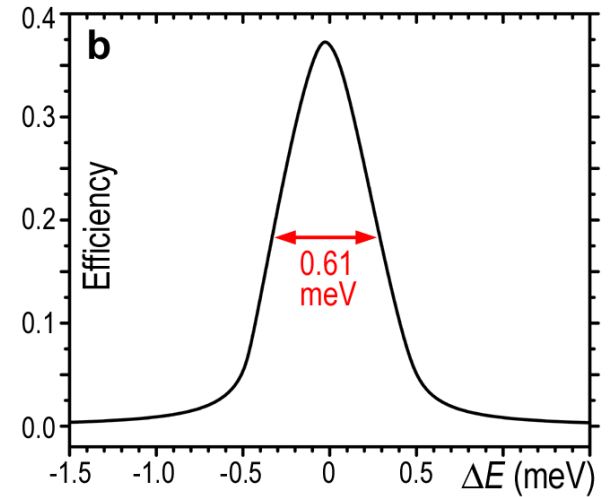
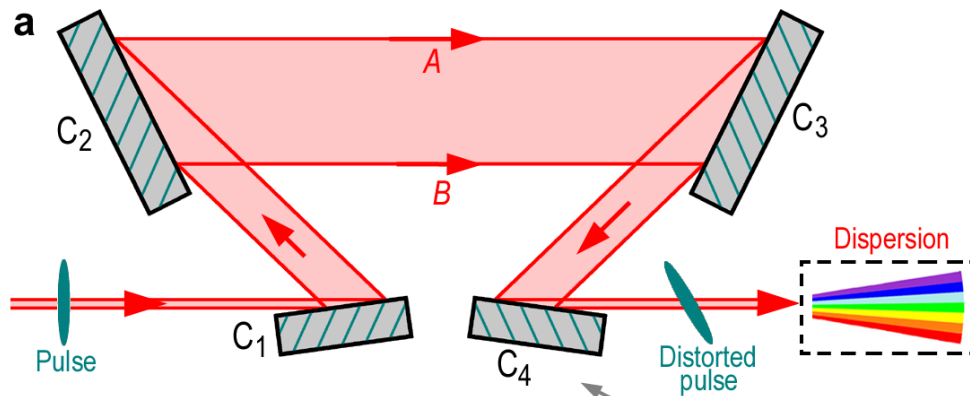

Dispersive monochromator

Fabrication, characterization, mounting of the HDCM of APS-U beamline 2-ID (with Tim Graber et al)

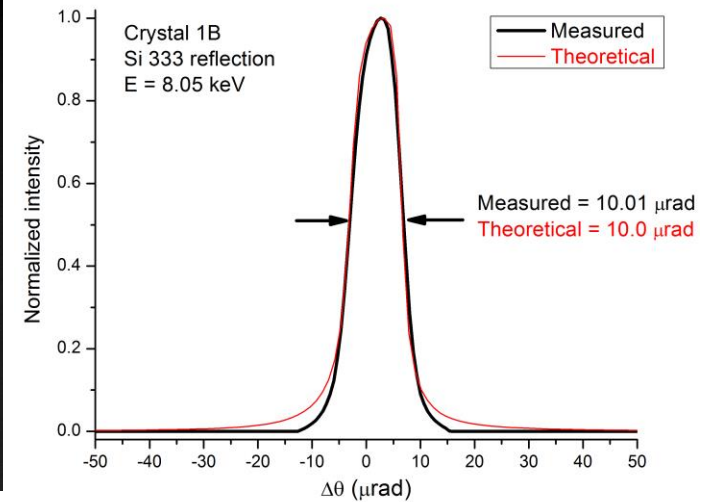
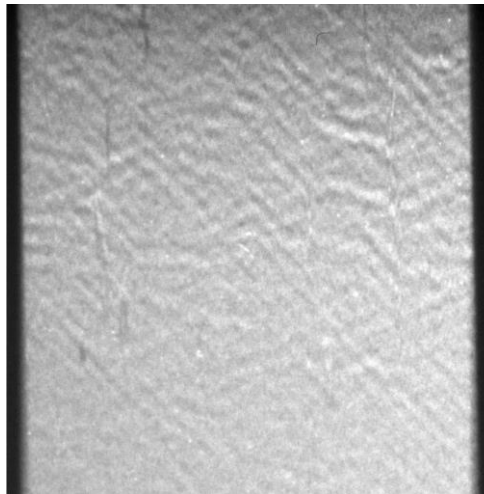
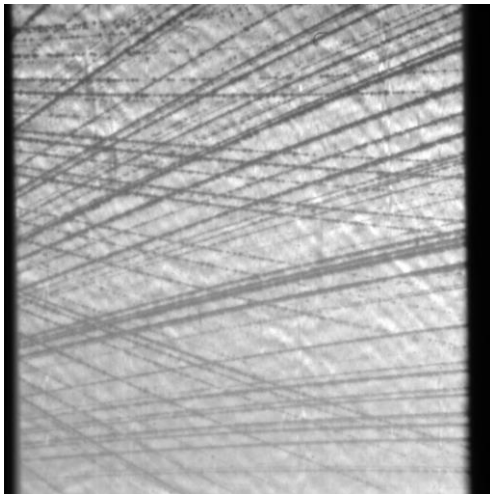
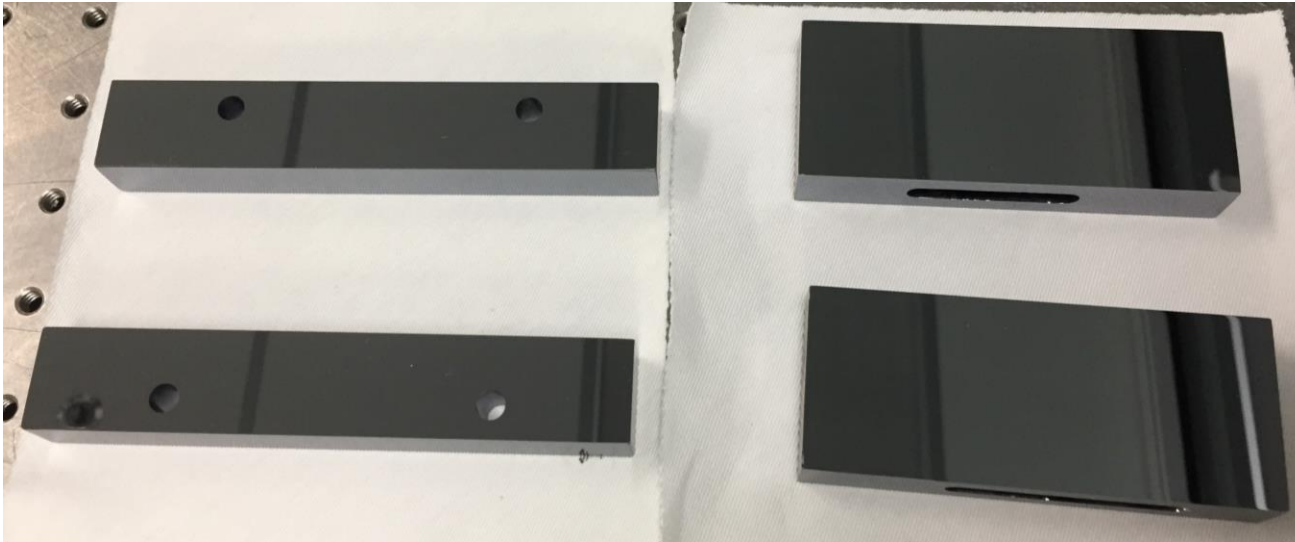

Crystal mounting and rocking curve imaging, almost strain-free installation achieved.

1st
crystal

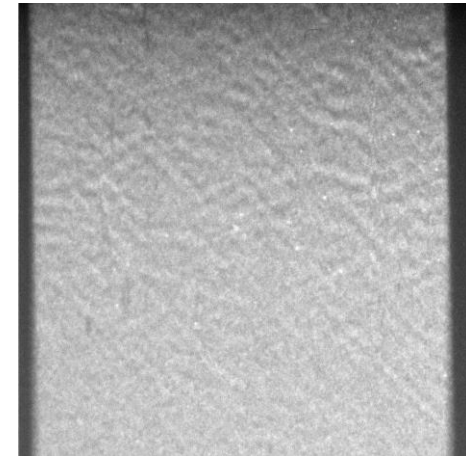
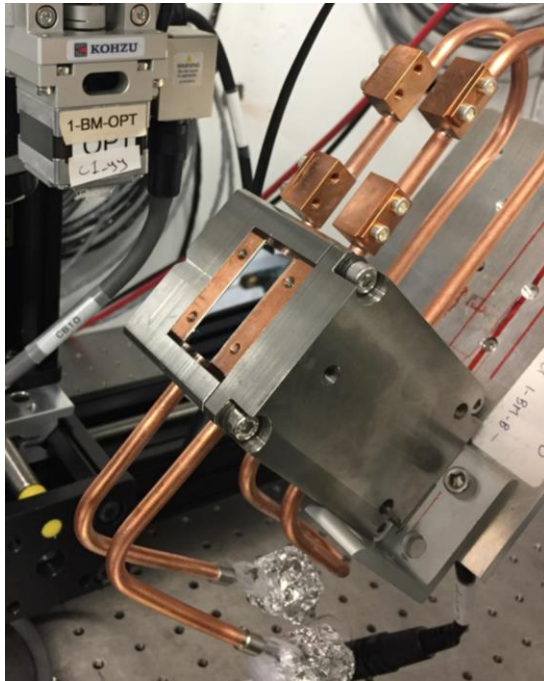

2nd
crystal

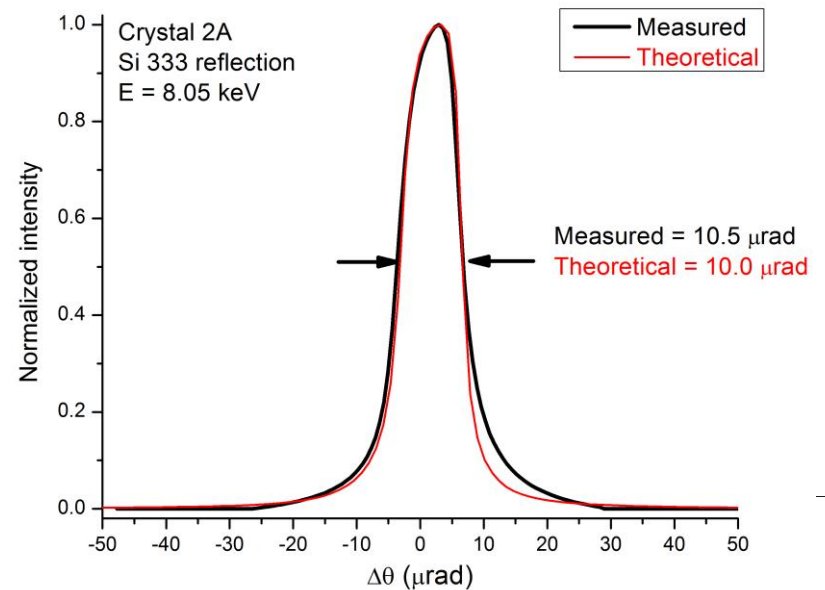
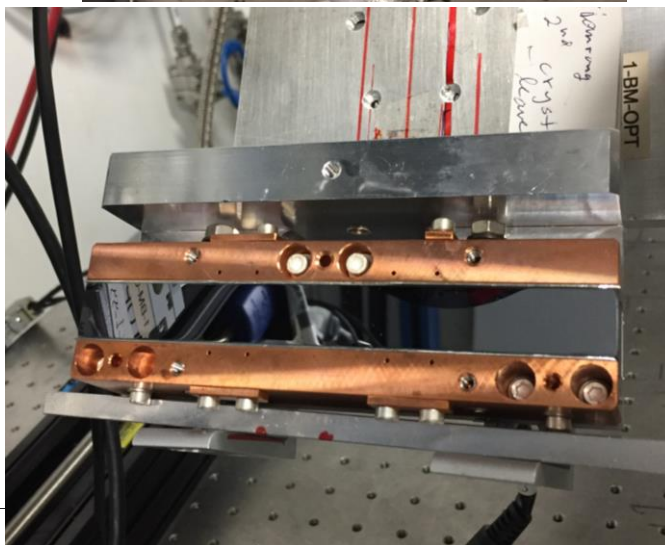

- To establish standard and completely reliable procedures for fabrication and installation of APS-U DCMs and other crystal optics.
- Performing characterization of each crystal after fabrication is time consuming.
- Fabrication errors are costly and can delay commissioning of beamlines by months.
- With mature procedures, we can avoid these problems.



Continue development of channel-cut polishing: C-CHiRP V3 (version 3)

- Capable of polishing long channel-cut > 200 mm
- For the Split-Delay Channelcut Optics at LCLS
- For making coherence-preservation channel-cut optics for APS and APS-U

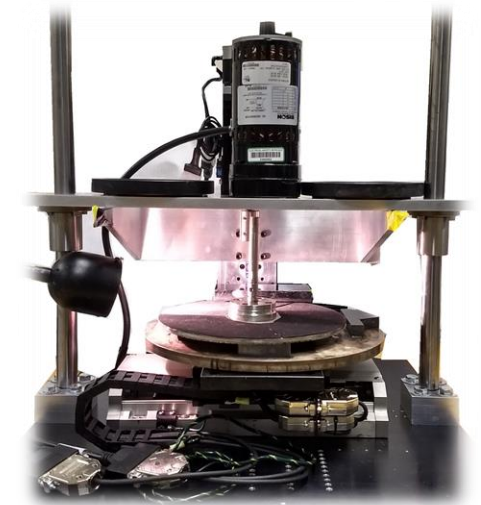

C-CHiRP
Channel-Cut High Resolution Polisher

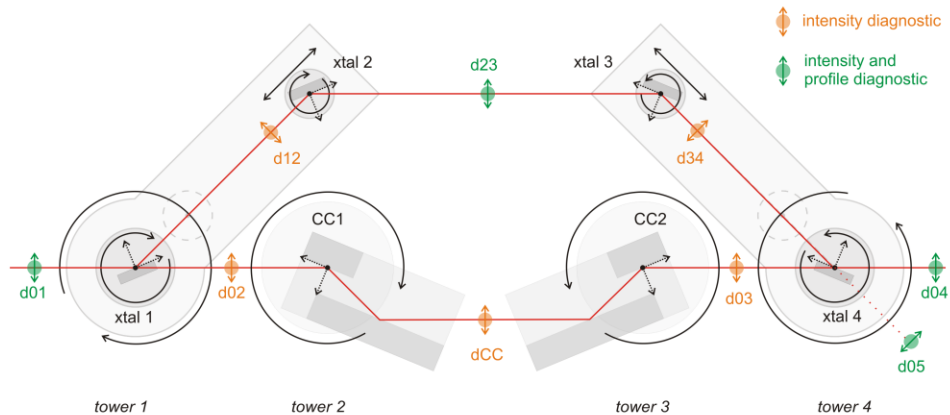

LCLS Split-Delay System Layout Schematics

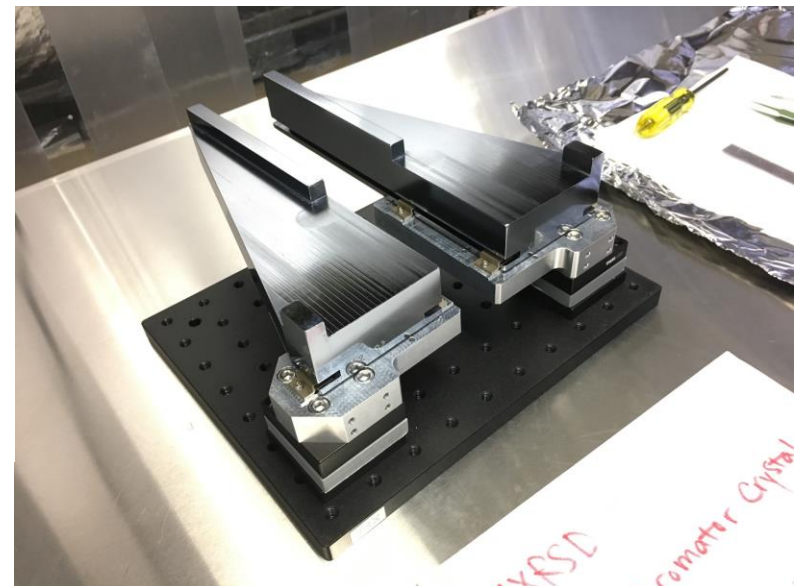

Long channel-cut-type crystals (CC1, CC2)



Plans for APS-U



1. New 18 kW rotating-anode source for Topo Unit

OPT has relatively comprehensive crystal optics fabrication and characterization instruments, but many are aging, outdated (nearly 20 years old). Replacement and upgrade are urgent for regular operation and for APS-U, particularly for acquiring a new 18-kW rotating-anode source (Rigaku) to resume operation of the Topo Unit.

- The Double-crystal rocking curve imaging capability at APS is unique in the US. After APS shuts down, there will be no beamline for crystal characterization. Lab-source-based Topo Unit will be the only possibility.
- APS-U will have a large number of new or refurbished crystal optics that will require Topo Unit for installation and testing.
- More than ten beamlines already requested the service of Topo Unit even during the short-period shut down. 1-BM has very limited beam time for Rocking curve imaging. Rocking curve imaging set-up is time consuming.
- Upgrade of the Topo Unit will also improve crystal orienting precision from $\sim 0.1^\circ$ to 0.02° .
- ...

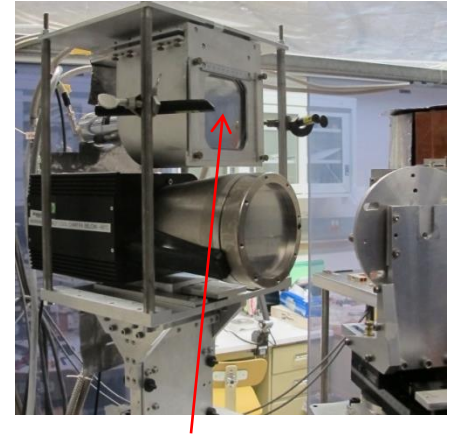

Dead CCD on the Topo Unit



Out-dated crystal orienter

2. Prepare for making new monochromators and refurbishing old monochromators for APS-U

- ❑ APS-U new beamlines will require a large number of new DCMs and other crystal optics. We are establishing standard and reliable fabrication procedures for making new DCMs and strain-free installation.
- ❑ APS-U will also provide an excellent opportunity for refurbishing a large number of aging crystal optics used at APS, particularly for those
 - Without careful strain minimization during earlier installation.
 - With oxidized or damaged surfaces, need cleaning, re-etching and re-polishing.
 - Recent refurbishing of some APS monochromators result in double to triple flux gain.

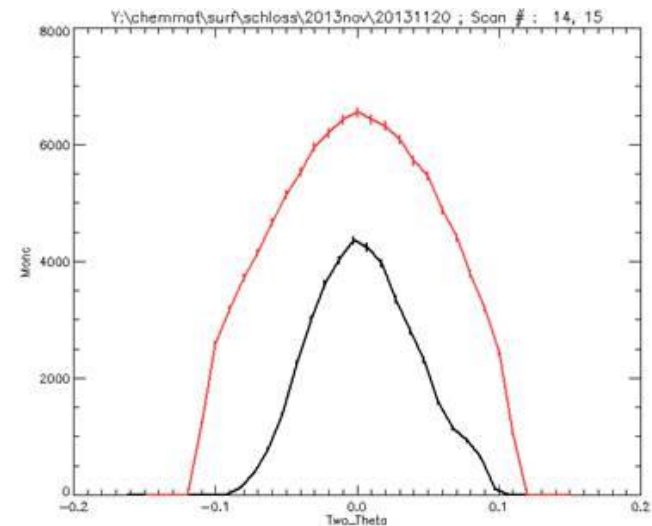
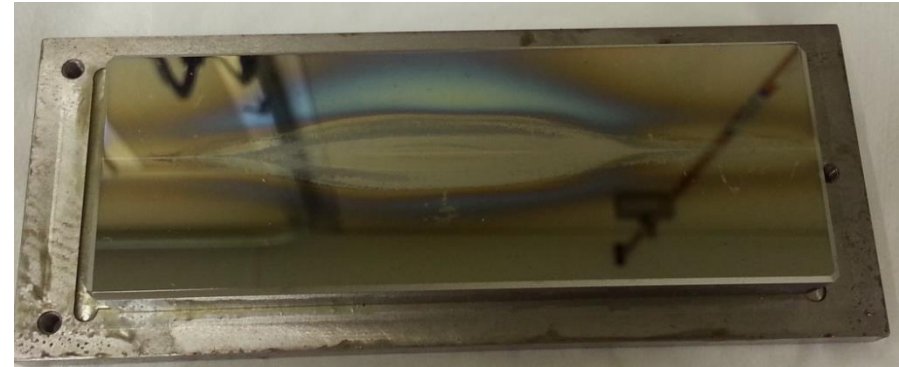

An surface-burnt Ge monochromator at Sector 15. After re-polishing, the flux is more than doubled, plus a number of other optical improvements.

3. Study crystal surface roughness influencing coherence, making asymmetric DCMs with wide bandpass

(collaboration with Al Macrander)

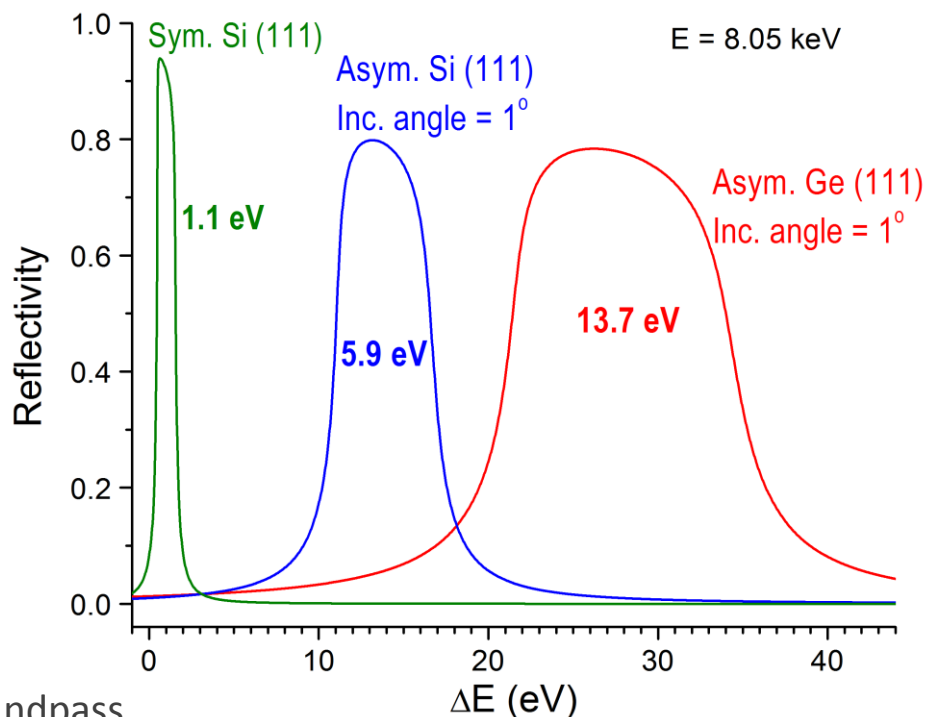
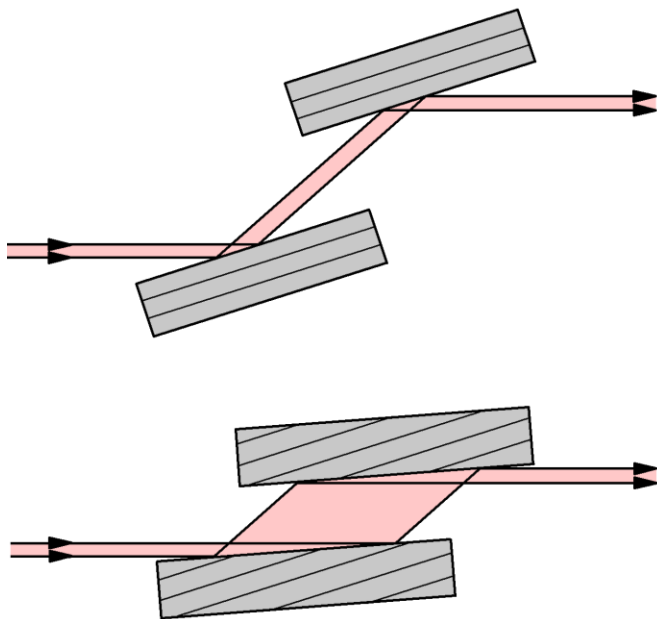

- Asymmetric DCMs can have much wider bandpass than symmetric DCMs (up to one order wider!).
- Much simpler and reliable than multilayer DCMs, better coherence preservation.
- Large footprint, less heat load density
- Cons: Grazing incidence/exit geometry, extremely low surface roughness required. Less energy range.
- Slight dispersion is not a problem if the gap is small.

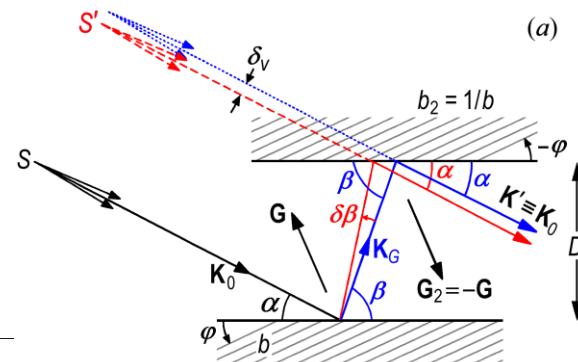

4. Thin-crystal high-energy monochromators

- Most high-energy Laue transmission monochromators are thick crystals, **from mm to cm**, producing rapid Pendellosung fringes, average efficiency low.
- Thin crystals, **ideally half of the Pendellosung thickness**, has doubled efficiency with smooth rocking curves.
- Easier bending, can be bond to pre-figured substrates with accurate shapes, for better focusing
- Need R&D support.

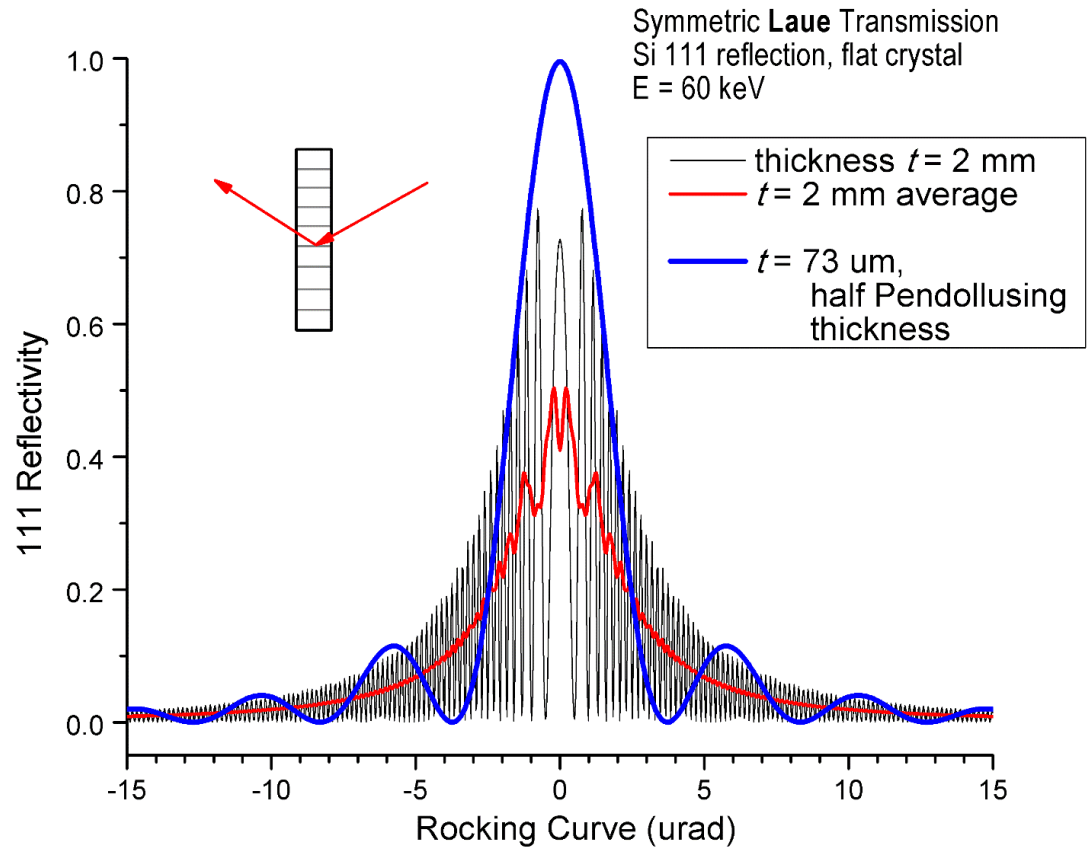

Summary

- OPT has comprehensive infrastructure and expertise for design, fabrication and development of crystal optics, **unique capabilities in the US**.
- **Operation:** Operate a wide purview of machines for in-house crystal fabrication and characterization, and we are capable of making almost any kinds of crystal optics, including various monochromators, analyzers, high-heat-load optics, high-energy optics, beam splitters, polarizers, FEL optics, etc.
- **Advantages of in-house fabrication:** cost effective, guaranteed high quality based on unique and reliable characterization capabilities, high customization, easy modification.
- **R&D:** Carry out innovative design and development of novel crystal optics and instrumentation, including strain-free super-polishing, channel-cut polishing, and X-ray characterization (topography); lead or participate in major optics development projects at APS as well as other National /International Labs, such as meV to sub-meV IXS, sub-10-meV RIXS, quartz/sapphire/diamond optics, crystal optics for X-ray coherence and imaging, etc
- **Plans for APS-U** include upgrading aging equipment, particularly the Topo Unit, establishing reliable and standard procedures for fabrication and installation of APS-U crystal optics, and for refurbishing old APS DCMs. Exploring novel crystal optics, including asymmetric DCMs, thin-crystal high-energy X-ray monochromators.



Acknowledgements

- ❖ OPT Group: Lahsen Assoufid, Group Leader
- ❖ OPT/Crystal optics team
- ❖ Albert T. Macrander, Michael Wojcik (topography and 1-BM support)
- ❖ Thomas Gog, Jungho Kim, Ayman Said, Diego Casa (RIXS and analyzers)
- ❖ Xianbo Shi, Tim Graber... (APS-U)
- ❖ E. E. Alp, T. Toellner, J. Zhao (APS Sector 3)
- ❖ Bill Burns (Central Shops)
- ❖ Deming Shu, Kurt Goetze (APS)
- ❖ and many others ...
- ❖ APS and XSD management for support

